



A6 to Manchester Airport Relief Road Transport Assessment Appendices



October 2013



A6 to Manchester Airport Relief Road

Transport Assessment Appendices

October 2013

Notice

This document and its contents have been prepared and are intended solely for Stockport Metropolitan Borough Council's information and use in relation to the A6 to Manchester Airport Relief Road scheme proposal.

Atkins Limited assumes no responsibility to any other party in respect of or arising out of or in connection with this document and/or its contents.

Document History

JOB NUMBER: 5088198			DOCUMENT REF: A6MARR_TA_Appendices_Final.docx			
1	Final	GR/AB	GR	NM	NM	Oct 13
Rev	Purpose Description	Originated	Checked	Reviewed	Authorised	Date

Main Text

Bound Separately

Appendices

Appendix A	4
A6MARR Highway Alignment/ Block Plans	4
Appendix B	29
SEMMMS Footpath Monitoring Report	29
Appendix C	31
COPECAT	31
Appendix D	61
Stage 1 Road Safety Audit	61
Appendix D.1	62
Stage 1 – Feasibility Road Safety Audit	62
Appendix D.2	70
Engineers Response to Stage 1 Road Safety Audit	70
Appendix E	74
Development Assumptions	74
Appendix F	93
Scheme Junction Model Output	93
Appendix F.1	94
A6MARR/ Realigned A6 LinSig Output	94
Appendix F.2	110
Realigned A6/ Buxton Road LinSig Output	110
Appendix F.3	126
A6MARR/ A523 Macclesfield Road LinSig Output	126
Appendix F.4	164
A6MARR/ Bramhall Oil Terminal Gyratory & A6MARR Link Road/ A5149 Chester Road LinSig Output	164
Appendix F.5	212
A6MARR/ A5102 Woodford Road LinSig Output	212
Appendix F.6	240
A34 Handforth Bypass/ A555 LinSig Output	240
Appendix F.7	283
A34/ B5094 Stanley Road LinSig Output	283
Appendix F.8	316
A6MARR/ B5358 Wilmslow Road ARCADY Output	316
Appendix F.9	344
A6MARR/ B5166 Styal Road LinSig Output	344
Appendix G	372
A6MARR Public Rights of Way	372

Appendix A

A6MARR Highway Alignment/ Block Plans

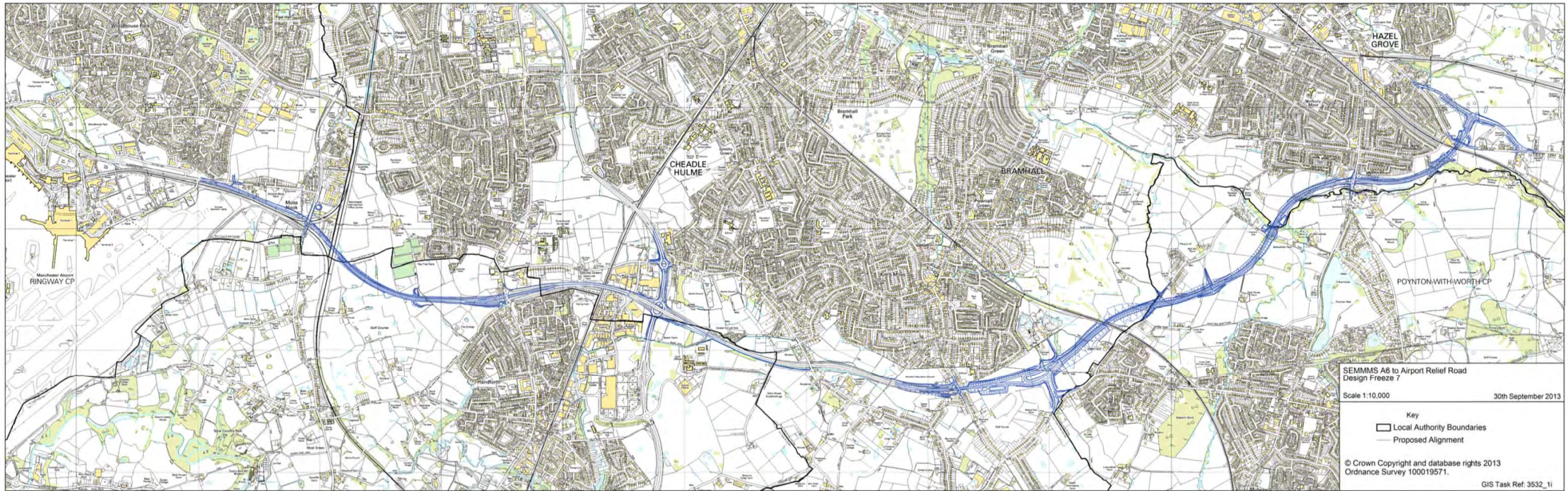

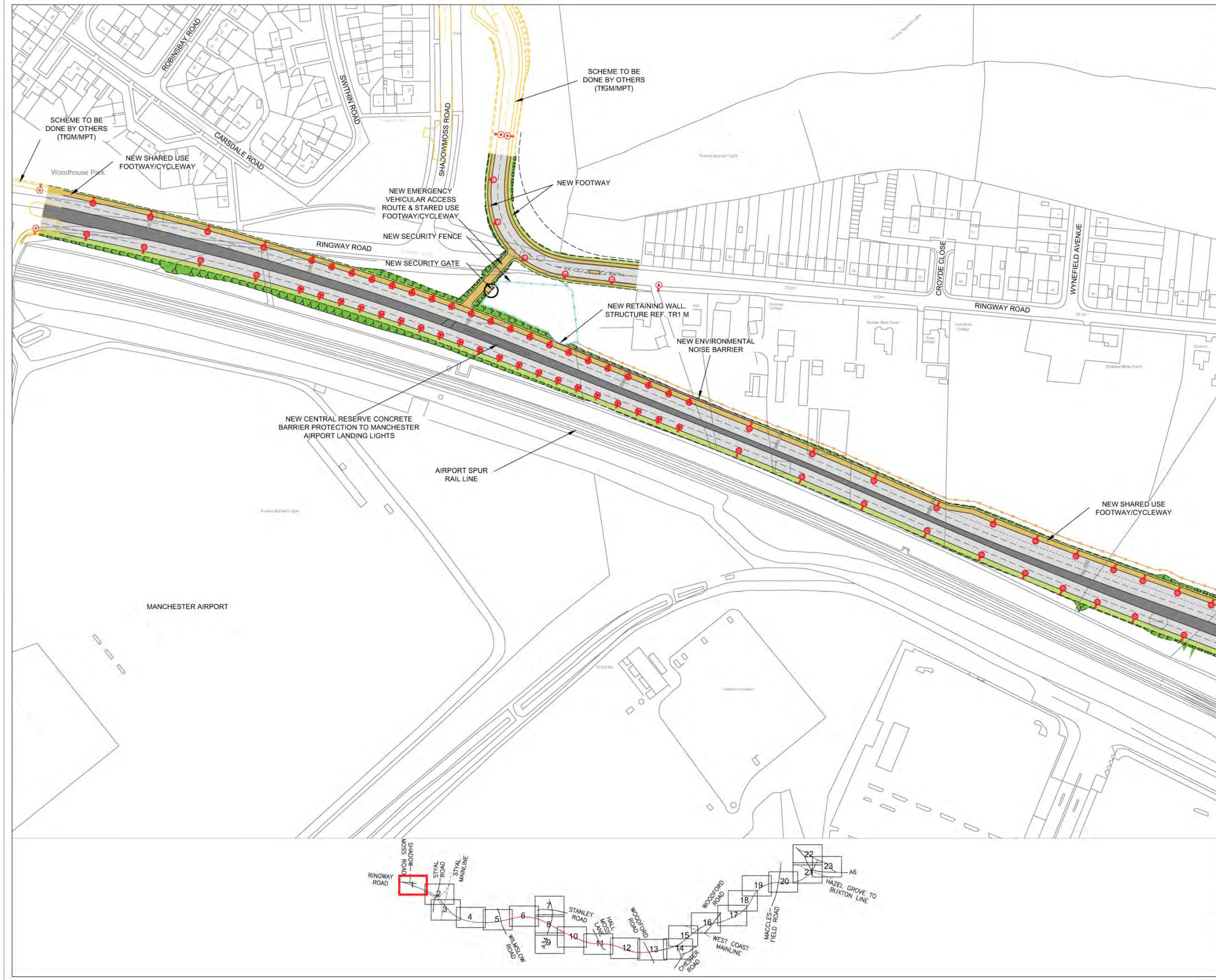

This map is reproduced from Ordnance Survey material with the permission of Ordnance Survey on behalf of the Controller of Her Majesty's Stationery Office © Crown copyright. Unauthorised reproduction infringes Crown copyright and may lead to prosecution or civil proceedings. Stockport Metropolitan Borough Council 100019571 2012

KEY

- PROPOSED CARPARK
- PROPOSED CENTRAL RESERVE
- PROPOSED FOOTWAY/SHARED USE FACILITY/BROOKLEYS
- PROPOSED FARMERS TRACK
- PROPOSED VERGE
- PROPOSED (UNGRAVELLED) EARTHWORKS
- PROPOSED ATTENUATION BASIN
- PROPOSED WATERCOURSE DIVERSION
- PROPOSED STRUCTURAL
- EXISTING PUBLIC RIGHTS OF WAY
- EXISTING PUBLIC RIGHTS OF WAY STOPPED UP

FENCING LEGEND

- PROPOSED 1.8m HIGH ACROUSTIC FENCING REFER TO DETAIL 011 DR0
- PROPOSED 3.0m HIGH ACROUSTIC FENCING REFER TO DETAIL 011 DR0
- PROPOSED TIMBER POST AND RAIL FENCING REFER TO STANDARD
- PROPOSED 1.8m HIGH SECURITY FENCE
- PROPOSED 4.2m HIGH BALL STOP MESH FENCE
- PROPOSED TEMPORARY FENCE
- PROPOSED GATE
- PROPOSED STREET LIGHTING COLUMNS

Rev.	Drawn	Checked	Date	Revision Details

www.semmms.info

STOCKPORT MANCHESTER CHESHIRE EAST

STOCKPORT HOUSE
 STOCKPORT, CHESHIRE
 TEL : 0161 474 4800
 FAX : 0161 474 4833

Job Title
A6 - MANCHESTER AIRPORT RELIEF ROAD

Drawing Title
PLANNING APPLICATION BLOCK PLANS PROPOSED SHEET 1

Drawn	Engineer	Checked	Approved
SEB/DP	SP	NH	AB
Date	Date	Date	Date
03.10.13	03.10.13	03.10.13	03.10.13
Size	Scale		
A1	1:1000		
SGC No.	Filename		
1007/30/DF7/A6-MA/PABP/P/023			

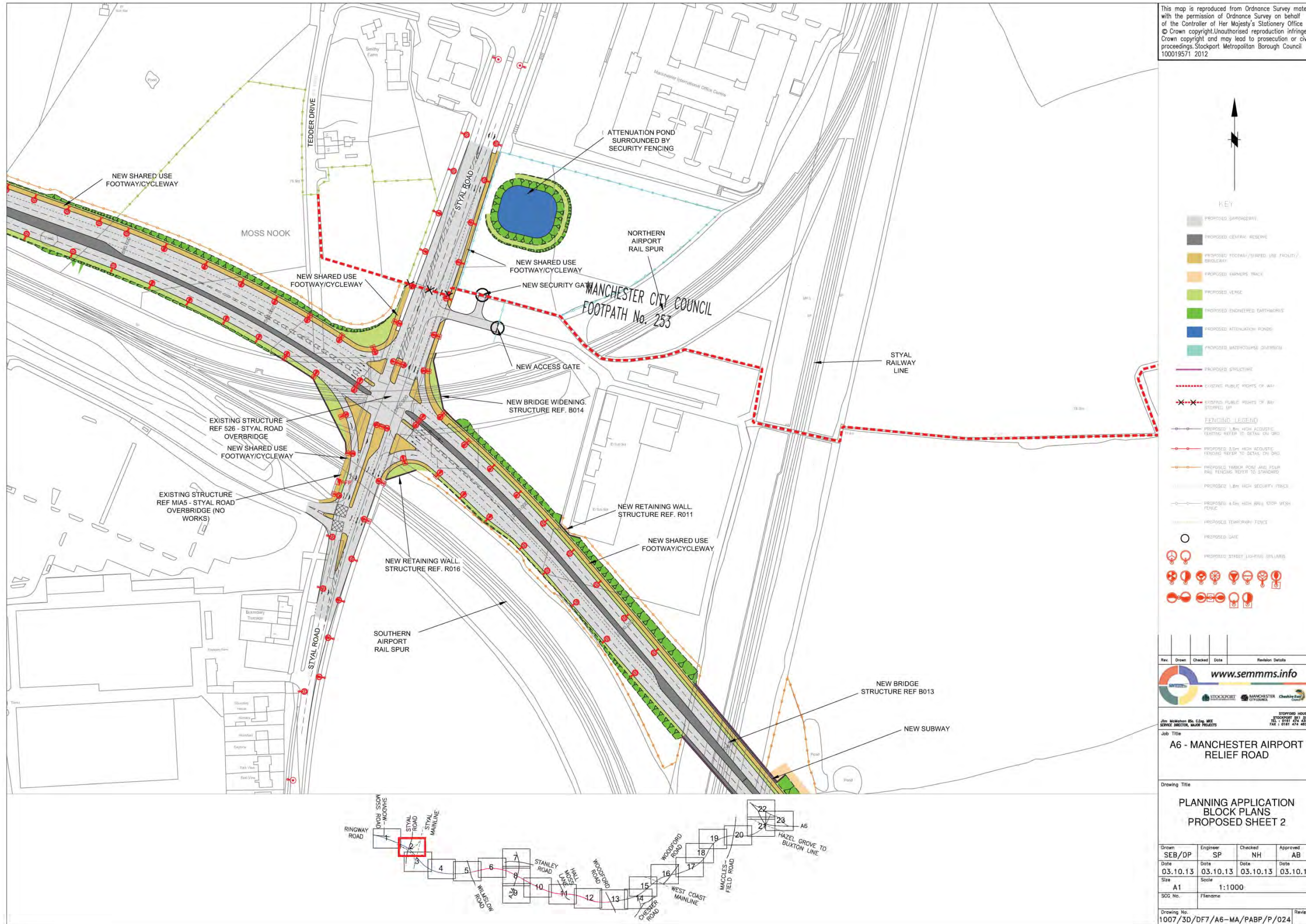

This map is reproduced from Ordnance Survey material with the permission of Ordnance Survey on behalf of the Controller of Her Majesty's Stationery Office. © Crown copyright. Unauthorised reproduction infringes Crown copyright and may lead to prosecution or civil proceedings. Stockport Metropolitan Borough Council 100019571 2012.

KEY

- PROPOSED GARROBEMENT
- PROPOSED GENERAL RESERVE
- PROPOSED FOOTWAY/SHARED USE FACILITY/BROOKWAY
- PROPOSED FARMERS TRACK
- PROPOSED VERGE
- PROPOSED ENGINEERED EARTHWORKS
- PROPOSED ATTENUATION POND
- PROPOSED WATERCOURSE DIVERSION
- PROPOSED STRUCTURE
- EXISTING PUBLIC RIGHTS OF WAY
- EXISTING PUBLIC RIGHTS OF WAY STOPPED UP

FENCING LEGEND

- PROPOSED 3.5m HIGH ACQUISITE FENCING REFER TO DETAIL ON DISC
- PROPOSED 1.8m HIGH ACQUISITE FENCING REFER TO DETAIL ON DISC
- PROPOSED 1.8m HIGH SECURITY FENCE
- PROPOSED 4.5m HIGH BALL STOP MESH FENCE
- PROPOSED TEMPORARY FENCE
- PROPOSED GATE
- PROPOSED STREET LIGHTING (SPLANS)

Rev	Drawn	Checked	Date	Revision Details

www.semmms.info
 STOCKPORT MANCHESTER CITY COUNCIL Cheshire East Council

John Moleham BSc, CEng, MICE
 SERVICE DIRECTOR, MAJOR PROJECTS

STOCKPORT HOUSE
 122-122B STYAL ROAD
 STYAL, STOCKPORT, CHESHIRE SK11 7JG
 TEL: 0161 474 4200
 FAX: 0161 474 4833

Job Title
A6 - MANCHESTER AIRPORT RELIEF ROAD

Drawing Title
PLANNING APPLICATION BLOCK PLANS PROPOSED SHEET 2

Drawn	Engineer	Checked	Approved
SEB/DP	SP	NH	AB
Date	Date	Date	Date
03.10.13	03.10.13	03.10.13	03.10.13
Size	Scale		
A1	1:1000		
SOC No.	Filename		
Drawing No.	Revision		
1007/3D/DF7/A6-MA/PABP/P/024			

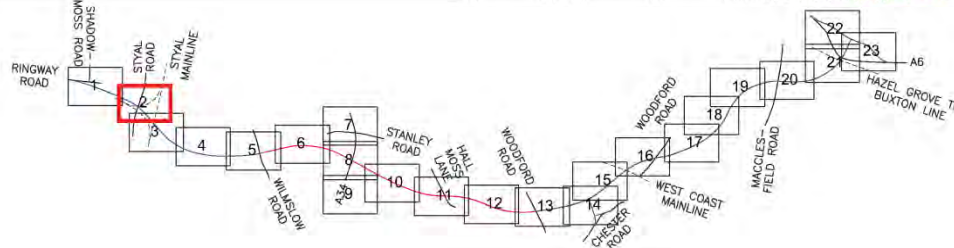



This map is reproduced from Ordnance Survey material with the permission of Ordnance Survey on behalf of the Controller of Her Majesty's Stationery Office. © Crown copyright. Unauthorised reproduction infringes Crown copyright and may lead to prosecution or civil proceedings. Stockport Metropolitan Borough Council 100019571 2012.

KEY

- PROPOSED GARDENWAY
- PROPOSED GENERAL RESERVE
- PROPOSED FOOTWAY/SHARED USE FACILITY/BROOKWAY
- PROPOSED FARMERS TRACK
- PROPOSED VERGE
- PROPOSED ENGINEERED EARTHWORKS
- PROPOSED ATTENUATION POND
- PROPOSED WATERCOURSE DIVERSION
- PROPOSED STRUCTURE
- EXISTING PUBLIC RIGHTS OF WAY
- EXISTING PUBLIC RIGHTS OF WAY STOPPED UP

FENCING LEGEND

- PROPOSED 1.8m HIGH ACQUISITION FENCING REFER TO DETAIL ON SHEET
- PROPOSED 3.0m HIGH ACQUISITION FENCING REFER TO DETAIL ON SHEET
- PROPOSED TOWER POST AND FOUR RAIL FENCING REFER TO STANDARD
- PROPOSED 1.8m HIGH SECURITY FENCE
- PROPOSED 4.0m HIGH BALL STOP HIGH FENCE
- PROPOSED TEMPORARY FENCE
- PROPOSED GATE
- PROPOSED STREET LIGHTING COLUMN

Rev.	Drawn	Checked	Date	Revision Details

www.semmms.info
 STOCKPORT MANCHESTER CITY COUNCIL Cheshire East Council

John Moulton BSc, CEng, MICE
 SERVICE DIRECTOR, MAJOR PROJECTS

STOCKPORT HOUSING
 122, 120, 121, 122
 TEL: 0161 474 4000
 FAX: 0161 474 4033

Job Title
A6 - MANCHESTER AIRPORT RELIEF ROAD

Drawing Title
**PLANNING APPLICATION
 BLOCK PLANS
 PROPOSED SHEET 3**

Drawn	Engineer	Checked	Approved
SEB/DP	SP	NH	AB
Date	Date	Date	Date
03.10.13	03.10.13	03.10.13	03.10.13
Size	Scale		
A1	1:1000		
SOC No.	Filename		
Drawing No.	Revision		
1007/30/DF7/A6-MA/PABP/P/025			

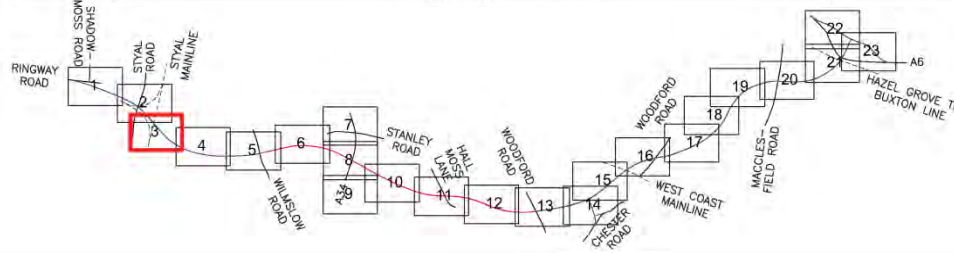

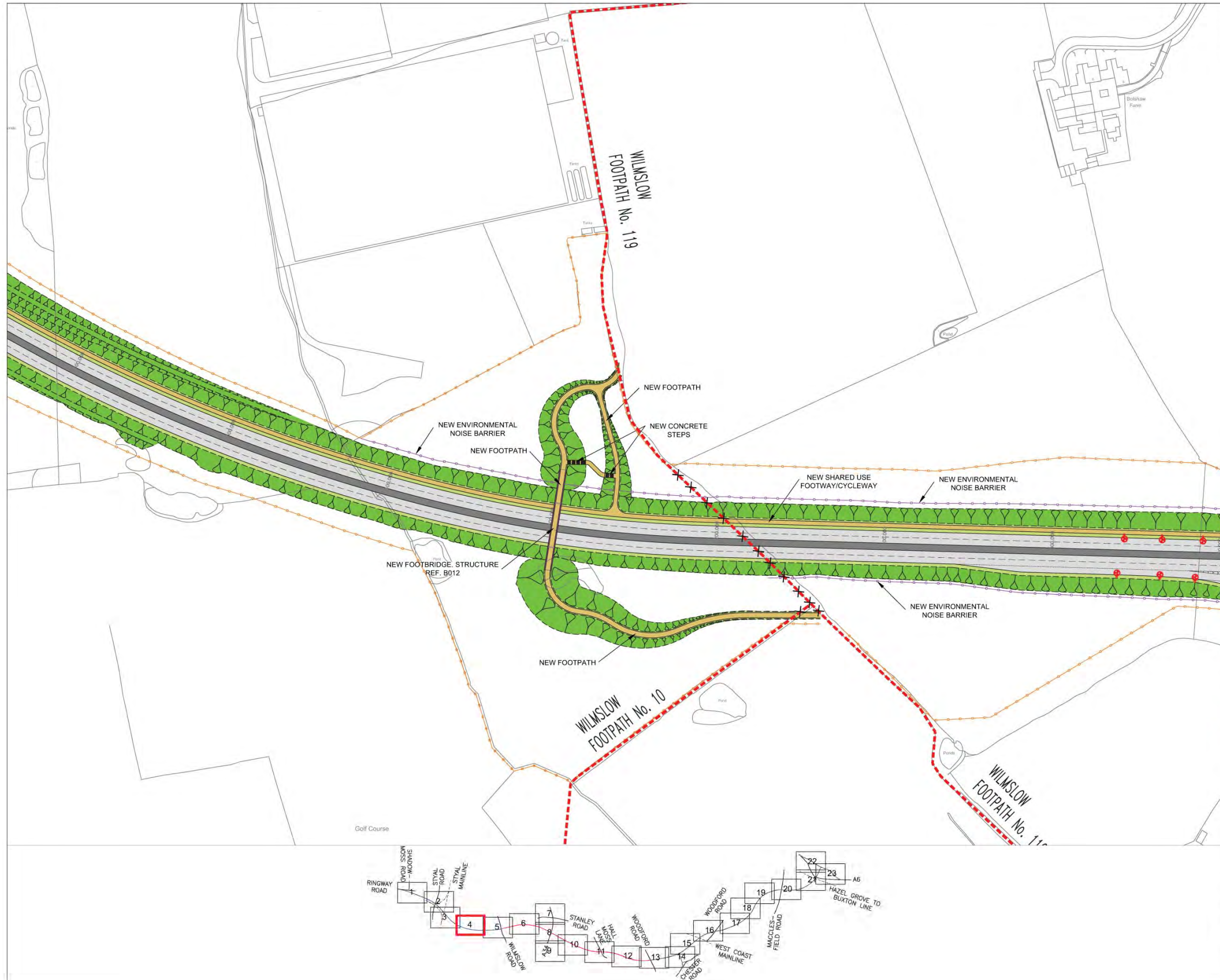

This map is reproduced from Ordnance Survey material with the permission of Ordnance Survey on behalf of the Controller of Her Majesty's Stationery Office © Crown copyright. Unauthorised reproduction infringes Crown copyright and may lead to prosecution or civil proceedings. Stockport Metropolitan Borough Council 100019571 2012

KEY

- PROPOSED CARPARKWAY
- PROPOSED CENTRAL RESERVE
- PROPOSED FOOTWAY/SHARED USE FACILITY/BROLEWAY
- PROPOSED FARMERS TRACK
- PROPOSED VERGE
- PROPOSED ENGINEERED EARTHWORKS
- PROPOSED ATTENUATION POND
- PROPOSED WATERCOURSE DIVERSION
- PROPOSED STRUCTURE
- EXISTING PUBLIC RIGHTS OF WAY
- EXISTING PUBLIC RIGHTS OF WAY STOPPED UP

FENCING LEGEND

- PROPOSED 1.8m HIGH ACROSTIC FENCING REFER TO DETAIL ON DISC
- PROPOSED 3.0m HIGH ACROSTIC FENCING REFER TO DETAIL ON DISC
- PROPOSED TANNER POST AND FOUR RAIL FENCING REFER TO STANDARD
- PROPOSED 1.8m HIGH SECURITY FENCE
- PROPOSED 4.0m HIGH BALL STOP MESH FENCE
- PROPOSED TEMPORARY FENCE
- PROPOSED GATE
- PROPOSED STREET LIGHTING (SCLAMP)

Rev	Drawn	Checked	Date	Revision Details

www.semmms.info

 Job Title
A6 - MANCHESTER AIRPORT RELIEF ROAD

Drawing Title
PLANNING APPLICATION BLOCK PLANS PROPOSED SHEET 4

Drawn	Engineer	Checked	Approved
SEB/DP	SP	NH	AB
Date	Date	Date	Date
03.10.13	03.10.13	03.10.13	03.10.13
Size	Scale		
A1	1:1000		
SOC No.	Filename		
Drawing No.	Revision		
1007/3D/DF7/A6-MA/PABP/P/026			

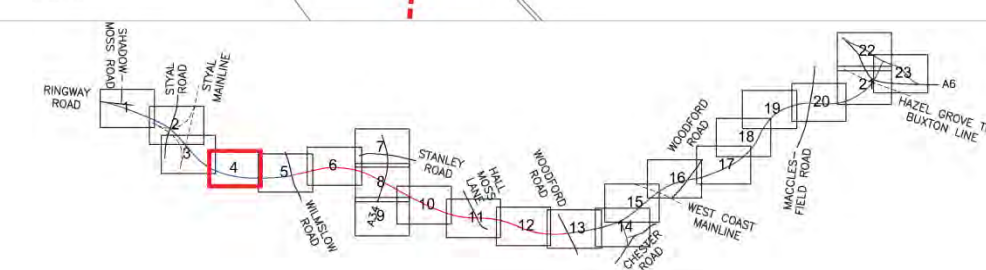

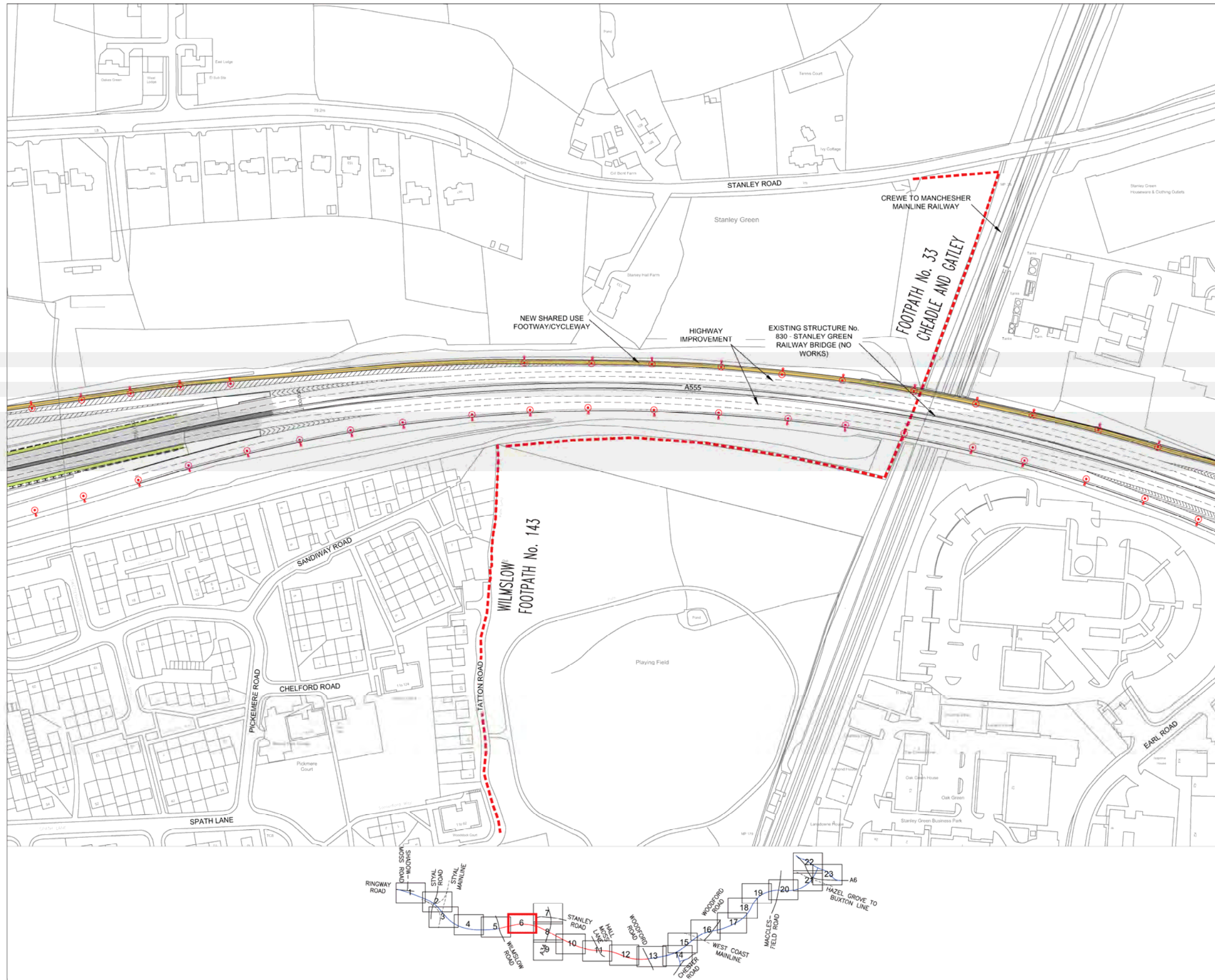

This map is reproduced from Ordnance Survey material with the permission of Ordnance Survey on behalf of the Controller of Her Majesty's Stationery Office © Crown copyright. Unauthorised reproduction infringes Crown copyright and may lead to prosecution or civil proceedings. Stockport Metropolitan Borough Council 100019571 2012

KEY

- PROPOSED GARDENWAY
- PROPOSED CENTRAL RESERVE
- PROPOSED FOOTWAY/SHARED USE FACILITY/BROOKWAY
- PROPOSED FARMERS TRACK
- PROPOSED VERGE
- PROPOSED ENGINEERED EARTHWORKS
- PROPOSED ATTENUATION BOND
- PROPOSED WATERCOURSE DIVERSION

PROPOSED SIGNAGE

EXISTING PUBLIC ROUTE OF WAY

EXISTING PUBLIC ROUTE OF WAY

PROPOSED 3.0M HIGH ACUSTIC FENCING REFER TO DETAIL ON DRG

PROPOSED TIMBER POST AND FOUR RAIL FENCING REFER TO SIGNAGE

PROPOSED 1.8M HIGH SECURITY FENCE

PROPOSED 4.0M HIGH BALL STOP MESH FENCE

PROPOSED TEMPORARY FENCE

PROPOSED GATE

PROPOSED GATE

PROPOSED STREET LIGHTING COLUMNS

www.semms.info

STOCKPORT MANCHESTER CHESHIRE EAST

STATION HOUSE
 STATION RD, STK
 TEL: 0161 474 4331
 FAX: 0161 474 4332

Job Title
A6 - MANCHESTER AIRPORT RELIEF ROAD

Drawing Title
PLANNING APPLICATION BLOCK PLANS PROPOSED SHEET 6

Drawn	Engineer	Checked	Approved
SEB/DP	SP	NH	AB
Date	Date	Date	Date
03.10.13	03.10.13	03.10.13	03.10.13
Size	Scale		
A1	1:1000		
SCG No.	Filename		
Drawing No.	Revision		
1007/30/DF7/A6-MA/PABP/P/02B			



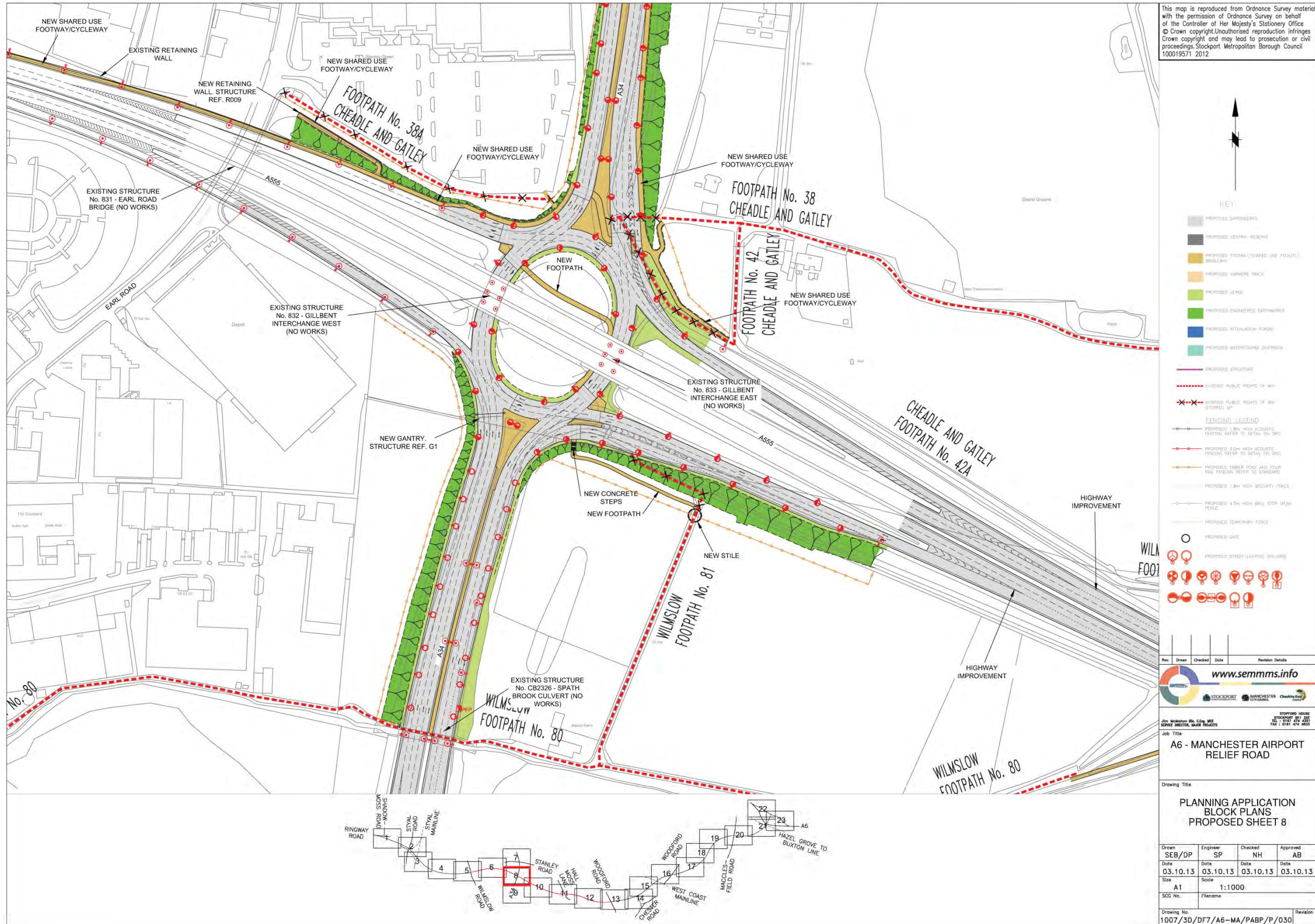

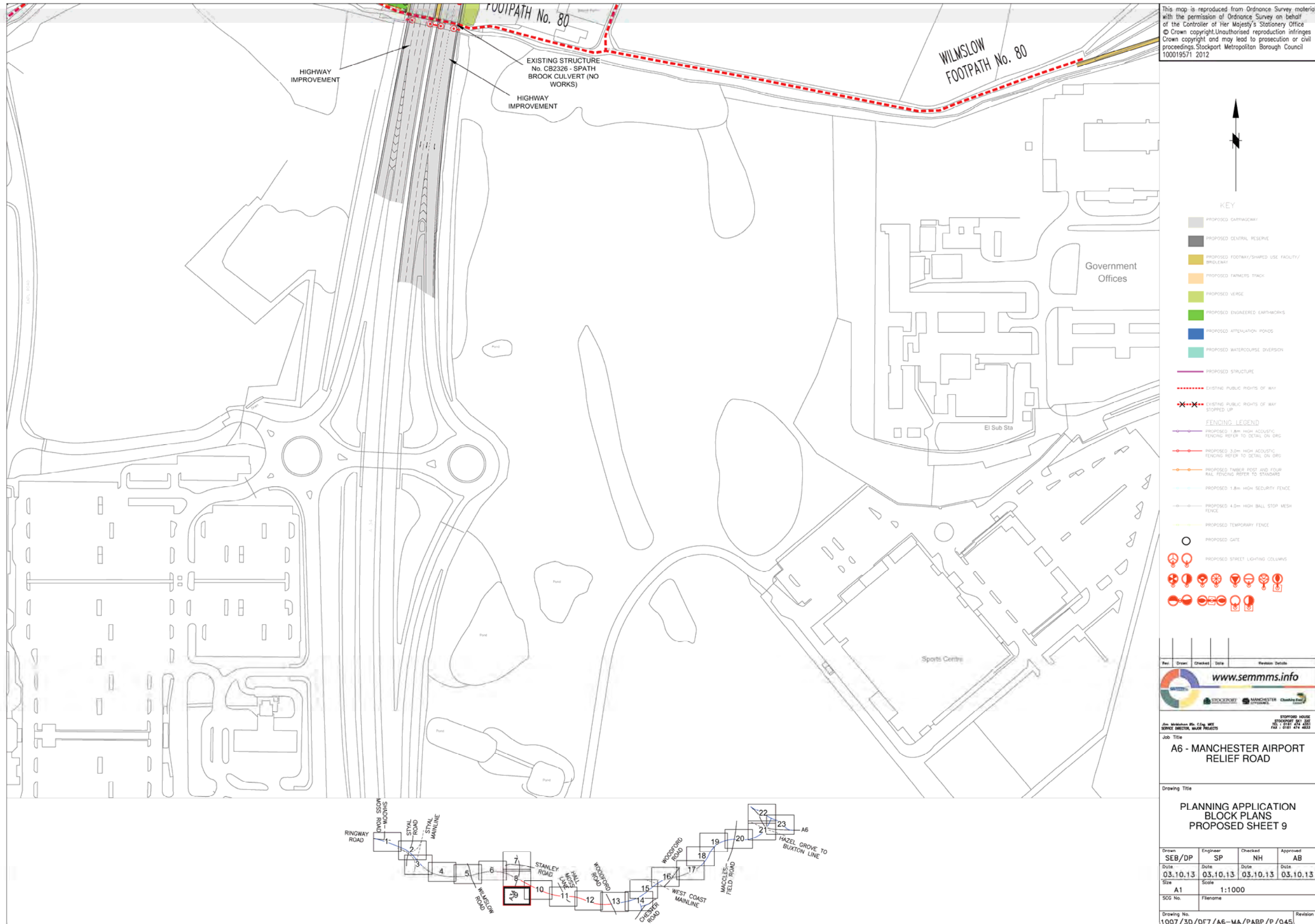

This map is reproduced from Ordnance Survey material with the permission of Ordnance Survey on behalf of the Controller of Her Majesty's Stationery Office © Crown copyright. Unauthorised reproduction infringes Crown copyright and may lead to prosecution or civil proceedings. Stockport Metropolitan Borough Council 100019571 2012

KEY

- PROPOSED GARRAGEWAY
- PROPOSED CENTRAL RESERVE
- PROPOSED FOOTWAY/SHARED USE FACILITY/BIKEWAY
- PROPOSED FARMERS TRACK
- PROPOSED VERGE
- PROPOSED ENGINEERED EARTHWORKS
- PROPOSED ATTENUATION POND
- PROPOSED WATERCOURSE DIVERSION
- PROPOSED STRUCTURE
- EXISTING PUBLIC RIGHTS OF WAY
- EXISTING PUBLIC RIGHTS OF WAY STOPPED UP

FENCING LEGEND

- PROPOSED 1.8m HIGH ACOUSTIC FENCING REFER TO DETAIL ON DRG
- PROPOSED 3.0m HIGH ACOUSTIC FENCING REFER TO DETAIL ON DRG
- PROPOSED TIMBER POST AND FOUR RAIL FENCING REFER TO STANDARD
- PROPOSED 1.8m HIGH SECURITY FENCE
- PROPOSED 4.0m HIGH BALL STOP MESH FENCE
- PROPOSED TEMPORARY FENCE
- PROPOSED GATE
- PROPOSED STREET LIGHTING COLUMNS

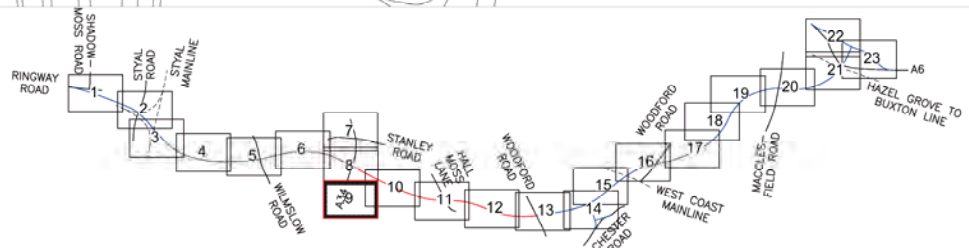

Rev	Drawn	Checked	Date	Revision Details
www.semms.info				
Job Title A6 - MANCHESTER AIRPORT RELIEF ROAD				
Drawing Title PLANNING APPLICATION BLOCK PLANS PROPOSED SHEET 9				
Drawn	Engineer	Checked	Approved	
SEB/DP	SP	NH	AB	
Date	Date	Date	Date	
03.10.13	03.10.13	03.10.13	03.10.13	
Size	Scale			
A1	1:1000			
SCG No.	Filename			
Drawing No.	Revision			
1007/30/DF7/A6-MA/PABP/P/045				

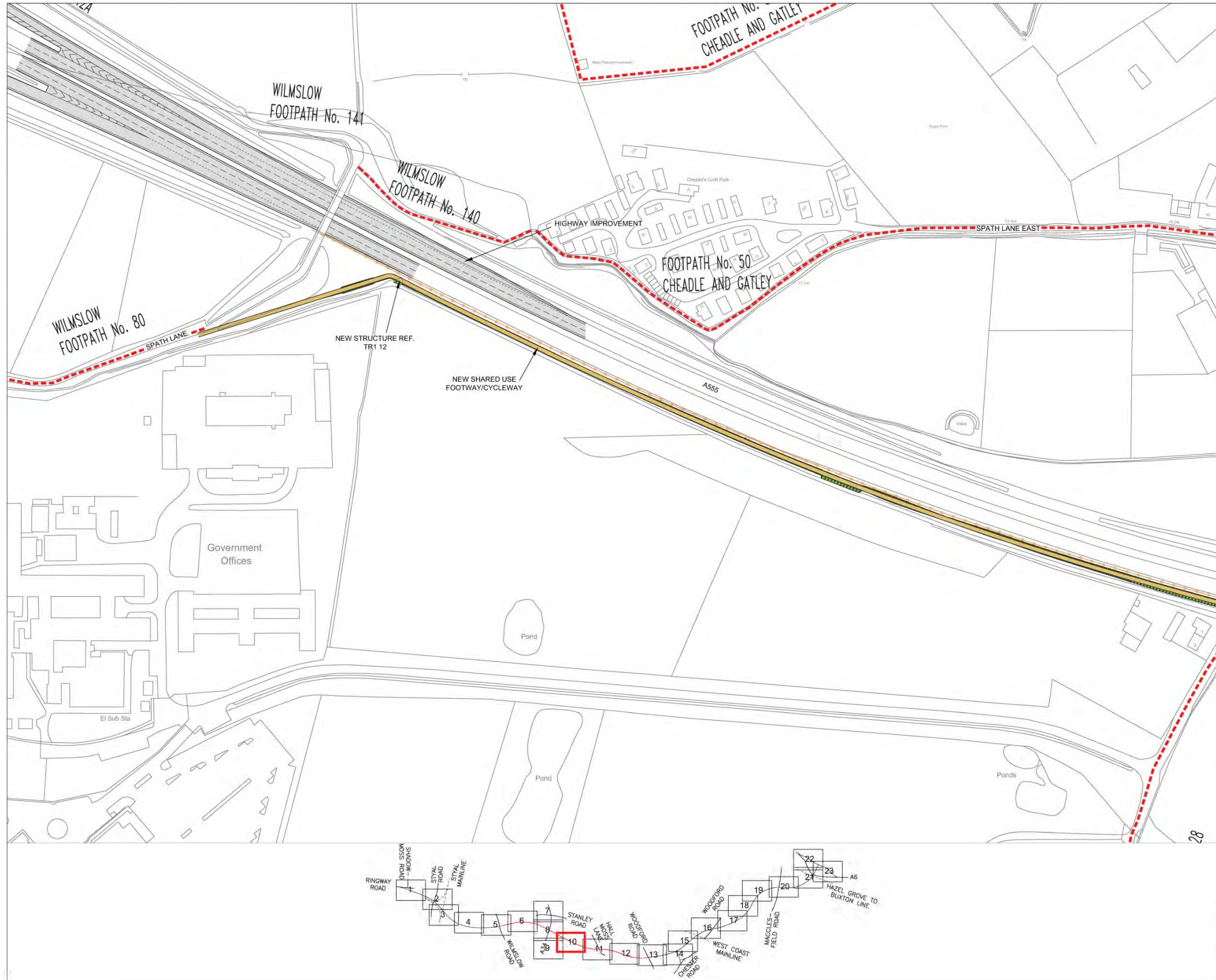

This map is reproduced from Ordnance Survey material with the permission of Ordnance Survey on behalf of the Controller of Her Majesty's Stationery Office. © Crown copyright. Unauthorised reproduction infringes Crown copyright and may lead to prosecution or civil proceedings. Stockport Metropolitan Borough Council 100019571 2012

KEY

- PROPOSED LANEWAYS
- PROPOSED GENERAL RESERVE
- PROPOSED FOOTWAY/SHARED USE FACILITY/BICYCLEWAY
- PROPOSED FARMERS TRACK
- PROPOSED VERGE
- PROPOSED ENGINEERED EARTHWORKS
- PROPOSED ATTENUATION POND
- PROPOSED WATERCOURSE DIVERSION
- PROPOSED STRUCTURE
- EXISTING PUBLIC RIGHTS OF WAY
- EXISTING PUBLIC RIGHTS OF WAY STOPPED UP

FENCING LEGEND

- PROPOSED 1.8m HIGH ACQUISITE FENCING REFER TO DETAIL ON SHEET
- PROPOSED 3.0m HIGH ACQUISITE FENCING REFER TO DETAIL ON SHEET
- PROPOSED FIBRE POST AND FOUR RAIL FENCING REFER TO STANDARD
- PROPOSED 1.8m HIGH SECURITY FENCE
- PROPOSED 4.0m HIGH BALL STOP HIGH FENCE
- PROPOSED TEMPORARY FENCE
- PROPOSED GATE
- PROPOSED STREET LIGHTING (SPLANS)

www.semmms.info

Job Title
A6 - MANCHESTER AIRPORT RELIEF ROAD

Drawing Title
PLANNING APPLICATION BLOCK PLANS PROPOSED SHEET 10

Drawn	Engineer	Checked	Approved
SEB/DP	SP	NH	AB
Date	Date	Date	Date
03.10.13	03.10.13	03.10.13	03.10.13
Size	Scale		
A1	1:1000		
SOC No.	Filename		
Drawing No.	Revision		
1007/3D/DF7/A6-MA/PABP/P/031			

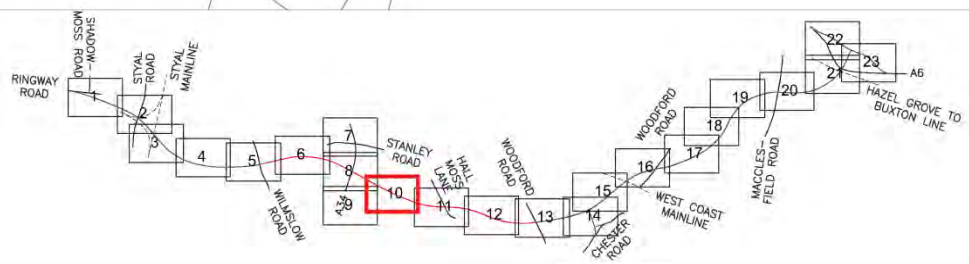

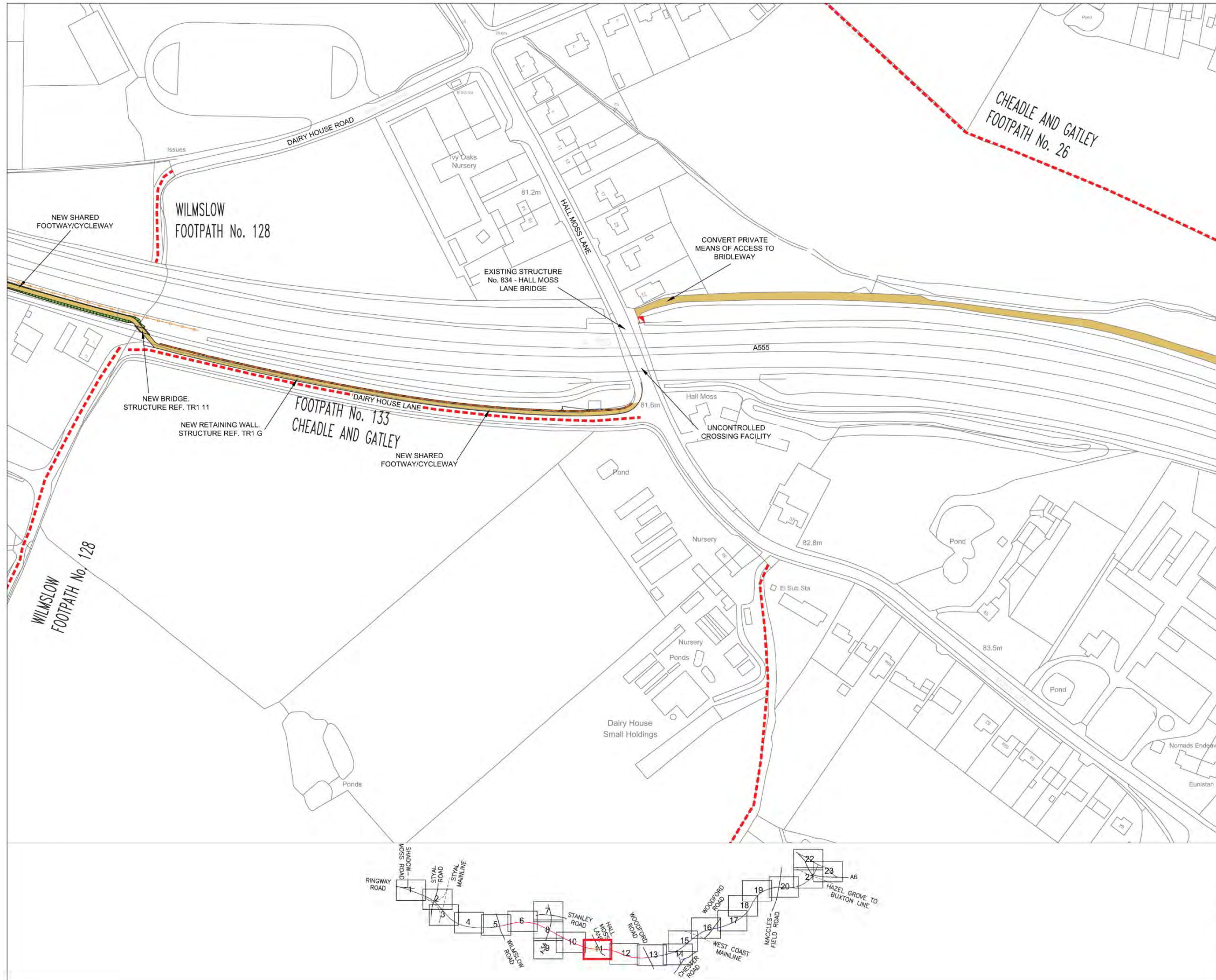

This map is reproduced from Ordnance Survey material with the permission of Ordnance Survey on behalf of the Controller of Her Majesty's Stationery Office. © Crown copyright. Unauthorised reproduction infringes Crown copyright and may lead to prosecution or civil proceedings. Stockport Metropolitan Borough Council 100019571 2012

KEY

- PROPOSED GARAGEWAY
- PROPOSED GENERAL RESERVE
- PROPOSED FOOTWAY/SHARED USE FACILITY/BRIDLEWAY
- PROPOSED FARMERS TRACK
- PROPOSED VENCE
- PROPOSED ENGINEERED EARTHWORKS
- PROPOSED ATTENUATION POND
- PROPOSED WATERCOURSE DIVERSION
- PROPOSED STRUCTURE
- EXISTING PUBLIC RIGHTS OF WAY
- EXISTING PUBLIC RIGHTS OF WAY STOPPED UP

FENCING LEGEND

- PROPOSED 1.8m HIGH ACQUISITIVE FENCING REFER TO DETAIL ON SHEET
- PROPOSED 3.0m HIGH ACQUISITIVE FENCING REFER TO DETAIL ON SHEET
- PROPOSED FENCE POST AND FOUR RAIL FENCING REFER TO STANDARD
- PROPOSED 1.8m HIGH SECURITY FENCE
- PROPOSED 4.0m HIGH BALL STOP VESH FENCE
- PROPOSED TEMPORARY FENCE
- PROPOSED DIRT
- PROPOSED STREET LIGHTING (SPLANS)

Rev	Drawn	Checked	Date	Revision Details

www.semmms.info
 Job Title
A6 - MANCHESTER AIRPORT RELIEF ROAD

Drawing Title
PLANNING APPLICATION BLOCK PLANS PROPOSED SHEET 11

Drawn	Engineer	Checked	Approved
SEB/DP	SP	NH	AB
Date	Date	Date	Date
03.10.13	03.10.13	03.10.13	03.10.13
Size	Scale		
A1	1:1000		
SOC No.	Filename		
Drawing No.	Revision		
1007/3D/DF7/A6-MA/PABP/P/032			



This map is reproduced from Ordnance Survey material with the permission of Ordnance Survey on behalf of the Controller of Her Majesty's Stationery Office. © Crown copyright. Unauthorised reproduction infringes Crown copyright and may lead to prosecution or civil proceedings. Stockport Metropolitan Borough Council 100019571 2012.

KEY

- PROPOSED GARDENWAY
- PROPOSED GENERAL RESERVE
- PROPOSED FOOTWAY/SHARED USE FACILITY/BRIDLEWAY
- PROPOSED FARMERS TRACK
- PROPOSED VERGE
- PROPOSED ENGINEERED EARTHWORKS
- PROPOSED ATTENUATION POND
- PROPOSED WATERCOURSE DIVERSION
- PROPOSED STRUCTURE
- EXISTING PUBLIC RIGHTS OF WAY
- EXISTING PUBLIC RIGHTS OF WAY STOPPED UP

FENCING LEGEND

- PROPOSED 1.8m HIGH ACQUISITION FENCING REFER TO DETAIL ON DISC
- PROPOSED 3.0m HIGH ACQUISITION FENCING REFER TO DETAIL ON DISC
- PROPOSED TIMBER POST AND FOUR RAIL FENCING REFER TO STANDARD
- PROPOSED 1.8m HIGH SECURITY FENCE
- PROPOSED 4.0m HIGH BALL STOP MESH FENCE
- PROPOSED TEMPORARY FENCE
- PROPOSED GATE
- PROPOSED STREET LIGHTING (SPLANS)

Rev.	Drawn	Checked	Date	Revision Details

www.semmms.info
 STOCKPORT MANCHESTER CHESHIRE EAST
 Job Title
A6 - MANCHESTER AIRPORT RELIEF ROAD

Drawing Title
PLANNING APPLICATION BLOCK PLANS PROPOSED SHEET 12

Drawn	Engineer	Checked	Approved
SEB/DP	SP	NH	AB
Date	Date	Date	Date
03.10.13	03.10.13	03.10.13	03.10.13
Size	Scale		
A1	1:1000		
SOC No.	Filename		
Drawing No.	Revision		
1007/3D/DF7/A6-MA/PABP/P/033			





This map is reproduced from Ordnance Survey material with the permission of Ordnance Survey on behalf of the Controller of Her Majesty's Stationery Office. © Crown copyright. Unauthorised reproduction infringes Crown copyright and may lead to prosecution or civil proceedings. Stockport Metropolitan Borough Council 100019571 2012.

KEY

- PROPOSED GARDENWAY
- PROPOSED GENERAL RESERVE
- PROPOSED FOOTWAY/SHARED USE FOOTWAY/BRIDLEWAY
- PROPOSED FARMERS TRACK
- PROPOSED VERGE
- PROPOSED ENGINEERED EARTHWORKS
- PROPOSED ATTENUATION POND
- PROPOSED WATERCOURSE DIVERSION
- PROPOSED STRUCTURE
- EXISTING PUBLIC RIGHTS OF WAY
- EXISTING PUBLIC RIGHTS OF WAY STOPPED UP

FENCING LEGEND

- PROPOSED 1.8m HIGH ACQUISITIVE FENCING REFER TO DETAIL ON DISC
- PROPOSED 3.0m HIGH ACQUISITIVE FENCING REFER TO DETAIL ON DISC
- PROPOSED TOWER POST AND FOUR RAIL FENCING REFER TO STANDARD
- PROPOSED 1.8m HIGH SECURITY FENCE
- PROPOSED 4.0m HIGH BALL STOP MESH FENCE
- PROPOSED TEMPORARY FENCE
- PROPOSED GATE
- PROPOSED STREET LIGHTING COLUMN

www.semms.info
 STOCKPORT MANCHESTER CITY COUNCIL Cheshire East Council

John Matheron BSc, CEng, MICE
 SERVICE DIRECTOR, MAJOR PROJECTS

STOCKPORT HOUSE
 122, SOUTH ST
 STOCKPORT, CHESHIRE SK7 2JF
 TEL: 0161 474 4000
 FAX: 0161 474 4033

Job Title
A6 - MANCHESTER AIRPORT RELIEF ROAD

Drawing Title
PLANNING APPLICATION BLOCK PLANS PROPOSED SHEET 14

Drawn	Engineer	Checked	Approved
SEB/DP	SP	NH	AB
Date	Date	Date	Date
03.10.13	03.10.13	03.10.13	03.10.13
Size	Scale		
A1	1:1000		
500 No.	Filename		
Drawing No.	Revision		
1007/30/DF7/A6-MA/PABP/P/035			

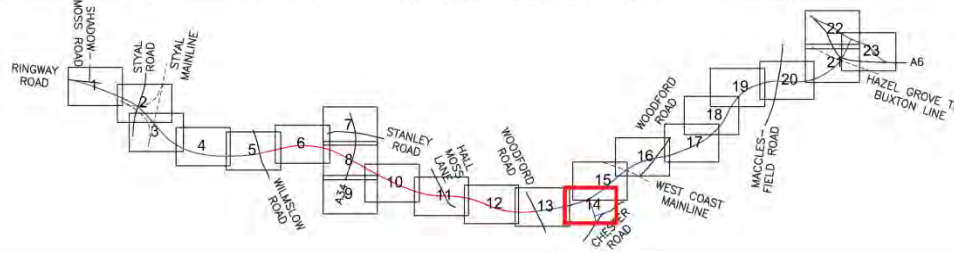



This map is reproduced from Ordnance Survey material with the permission of Ordnance Survey on behalf of the Controller of Her Majesty's Stationery Office. © Crown copyright. Unauthorised reproduction infringes Crown copyright and may lead to prosecution or civil proceedings. Stockport Metropolitan Borough Council 100019571 2012

KEY

- PROPOSED GARAGEWAY
- PROPOSED GENERAL RESERVE
- PROPOSED FOOTWAY/SHARED USE FOOTWAY/BROOKWAY
- PROPOSED FARMERS TRACK
- PROPOSED VERGE
- PROPOSED ENGINEERED EARTHWORKS
- PROPOSED ATTENUATION POND
- PROPOSED WATERCOURSE DIVERSION
- PROPOSED STRUCTURE
- EXISTING PUBLIC RIGHTS OF WAY
- EXISTING PUBLIC RIGHTS OF WAY STOPPED UP

FENCING LEGEND

- PROPOSED 1.8m HIGH ACQUISITIVE FENCING REFER TO DETAIL ON SHEET
- PROPOSED 3.6m HIGH ACQUISITIVE FENCING REFER TO DETAIL ON SHEET
- PROPOSED TOWER POST AND FOUR RAIL FENCING REFER TO STANDARD
- PROPOSED 1.8m HIGH SECURITY FENCE
- PROPOSED 4.0m HIGH BALL STOP MESH FENCE
- PROPOSED TEMPORARY FENCE
- PROPOSED GATE
- PROPOSED STREET LIGHTING (SIGNALS)

www.semmms.info

Job Title
A6 - MANCHESTER AIRPORT RELIEF ROAD

Drawing Title
PLANNING APPLICATION BLOCK PLANS PROPOSED SHEET 15

Drawn	Engineer	Checked	Approved
SEB/DP	SP	NH	AB
Date	Date	Date	Date
03.10.13	03.10.13	03.10.13	03.10.13
Size	Scale		
A1	1:1000		
SOC No.	Filename		
Drawing No.	Revision		
1007/30/DF7/A6-MA/PABP/P/036			

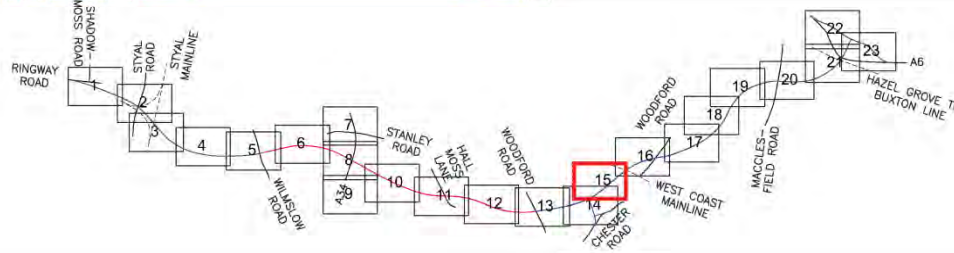



This map is reproduced from Ordnance Survey material with the permission of Ordnance Survey on behalf of the Controller of Her Majesty's Stationery Office. © Crown copyright. Unauthorised reproduction infringes Crown copyright and may lead to prosecution or civil proceedings. Stockport Metropolitan Borough Council 100019571 2012

KEY

- PROPOSED GARDENWAY
- PROPOSED GENERAL RESERVE
- PROPOSED FOOTWAY/SHARED USE FACILITY/BROOKWAY
- PROPOSED FARMERS TRACK
- PROPOSED VERGE
- PROPOSED ENGINEERED EARTHWORKS
- PROPOSED ATTENUATION POND
- PROPOSED WATERCOURSE DIVERSION
- PROPOSED STRUCTURE
- EXISTING PUBLIC RIGHTS OF WAY
- EXISTING PUBLIC RIGHTS OF WAY STOPPED UP

FENCING LEGEND

- PROPOSED 1.8m HIGH ACQUISITION FENCING REFER TO DETAIL ON S10
- PROPOSED 3.0m HIGH ACQUISITION FENCING REFER TO DETAIL ON S10
- PROPOSED 1.8m HIGH SECURITY FENCE
- PROPOSED 4.0m HIGH BALL STOP FENCE
- PROPOSED TEMPORARY FENCE
- PROPOSED GATE
- PROPOSED STREET LIGHTING (SPLANS)

Rev.	Drawn	Checked	Date	Revision Details

www.semmms.info
 STOCKPORT MANCHESTER CITY COUNCIL Cheshire East Council

Job Title
A6 - MANCHESTER AIRPORT RELIEF ROAD

Drawing Title
PLANNING APPLICATION BLOCK PLANS PROPOSED SHEET 16

Drawn	Engineer	Checked	Approved
SEB/DP	SP	NH	AB
Date	Date	Date	Date
03.10.13	03.10.13	03.10.13	03.10.13
Size	Scale		
A1	1:1000		
SOC No.	Filename		
Drawing No.	Revision		
1007/30/DF7/A6-MA/PABP/P/037			



This map is reproduced from Ordnance Survey material with the permission of Ordnance Survey on behalf of the Controller of Her Majesty's Stationery Office. © Crown copyright. Unauthorised reproduction infringes Crown copyright and may lead to prosecution or civil proceedings. Stockport Metropolitan Borough Council 100019571 2012

KEY

- PROPOSED GARMPERWAY
- PROPOSED GENERAL RESERVE
- PROPOSED FOOTWAY/SHARED USE FOOTWAY/BROOKWAY
- PROPOSED FARMERS TRACK
- PROPOSED VERGE
- PROPOSED ENGINEERED EARTHWORKS
- PROPOSED ATTENUATION PONDS
- PROPOSED WATERCOURSE DIVERSION
- PROPOSED STRUCTURE
- EXISTING PUBLIC RIGHTS OF WAY
- EXISTING PUBLIC RIGHTS OF WAY STOPPED UP

FENCING LEGEND

- PROPOSED 1.8m HIGH ACQUISITION FENCING REFER TO DETAIL ON DISC
- PROPOSED 3.0m HIGH ACQUISITION FENCING REFER TO DETAIL ON DISC
- PROPOSED TANNER POST AND FOUR RAIL FENCING REFER TO STANDARD
- PROPOSED 1.8m HIGH SECURITY FENCE
- PROPOSED 4.0m HIGH BALL STOP MESH FENCE
- PROPOSED TEMPORARY FENCE
- PROPOSED GATE
- PROPOSED STREET LIGHTING (SIGNALS)

Rev.	Drawn	Checked	Date	Revision Details

www.semmms.info
 STOCKPORT MANCHESTER CITY COUNCIL Cheshire East Council

Job Title
A6 - MANCHESTER AIRPORT RELIEF ROAD

Drawing Title
PLANNING APPLICATION BLOCK PLANS PROPOSED SHEET 17

Drawn	Engineer	Checked	Approved
SEB/DP	SP	NH	AB
Date	Date	Date	Date
03.10.13	03.10.13	03.10.13	03.10.13
Size	Scale		
A1	1:1000		
SOC No.	Filename		
Drawing No.	Revision		
1007/30/DF7/A6-MA/PABP/P/038			

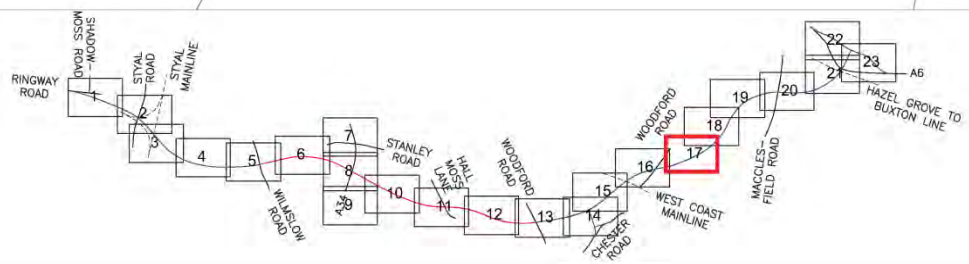



This map is reproduced from Ordnance Survey material with the permission of Ordnance Survey on behalf of the Controller of Her Majesty's Stationery Office. Crown copyright. Unauthorised reproduction infringes Crown copyright and may lead to prosecution or civil proceedings. Stockport Metropolitan Borough Council 100019571 2012

KEY

- PROPOSED CARPARK
- PROPOSED CENTRAL FERRYWAY
- PROPOSED FOOTWAY (SHARED USE FOOTWAY) BROADWAY
- PROPOSED FARMER TRACK
- PROPOSED VERGE
- PROPOSED ENGINEERED SLOPES
- PROPOSED ATTENUATION POND
- PROPOSED BARRIERS/DIVERSION
- PROPOSED STRUCTURE
- EXISTING PUBLIC RIGHTS OF WAY
- EXISTING PUBLIC RIGHTS OF WAY STOPPED UP

FENCING LEGEND

- PROPOSED 1.8m HIGH ADJUSTED FENCING REFER TO SCALE ON D18
- PROPOSED 3.0m HIGH ADJUSTED FENCING REFER TO SCALE ON D18
- PROPOSED 3.0m HIGH ADJUSTED FENCING REFER TO SCALE ON D18
- PROPOSED 3.0m HIGH SECURITY FENCE
- PROPOSED 4.0m HIGH BALL TOP FENCING REFER TO SCALE ON D18
- PROPOSED TELEGRAPH TOWER
- PROPOSED GATE
- PROPOSED STREET LIGHTING COLUMN

Rev.	Drawn	Checked	Date	Revision Details

www.semmms.info

STOCKPORT MANCHESTER CITY COUNCIL CHESHIRE EAST COUNCIL

Jim Mahon BSc. CEng. MICE
 SERVICE DIRECTOR, MAJOR PROJECTS

STOCKPORT HOUSING
 STOCKPORT 917 300
 TEL: 0161 474 4000
 FAX: 0161 474 4655

Job Title
A6 - MANCHESTER AIRPORT RELIEF ROAD

Drawing Title
PLANNING APPLICATION BLOCK PLANS PROPOSED SHEET 18

Drawn	Engineer	Checked	Approved
SEB/DP	SP	NH	AB
Date	Date	Date	Date
03.10.13	03.10.13	03.10.13	03.10.13
Size	Scale		
A1	1:1000		
SCD No.	Filename		
1007/3D/DF7/A6-MA/PABP/P/039			
Drawing No.	Revision		
1007/3D/DF7/A6-MA/PABP/P/039			

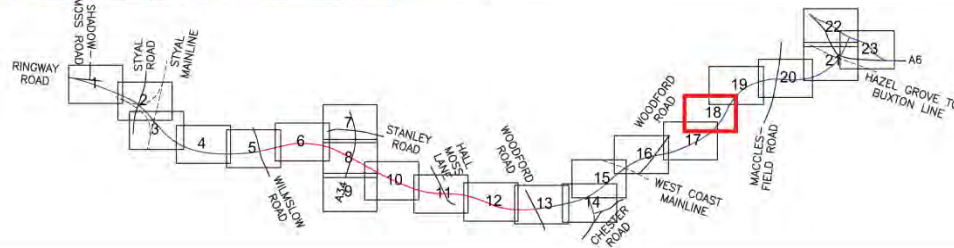



This map is reproduced from Ordnance Survey material with the permission of Ordnance Survey on behalf of the Controller of Her Majesty's Stationery Office © Crown copyright. Unauthorised reproduction infringes Crown copyright and may lead to prosecution or civil proceedings. Stockport Metropolitan Borough Council 100019571 2012

KEY

- PROPOSED CARPARK
- PROPOSED CENTRAL RESERVE
- PROPOSED FOOTWAY/SHARED USE FACILITY/BIKELANE
- PROPOSED FARMERS TRACK
- PROPOSED VERGE
- PROPOSED (UNGRAVELLED) EARTHWORKS
- PROPOSED ATTENUATION POND
- PROPOSED WATERCOURSE OVERSPILL
- PROPOSED STRUCTURAL
- EXISTING PUBLIC RIGHTS OF WAY
- EXISTING PUBLIC RIGHTS OF WAY STOPPED UP

FENCING LEGEND

- PROPOSED 1.8m HIGH ACROUSTIC FENCING REFER TO DETAIL ON DRG
- PROPOSED 3.0m HIGH ACROUSTIC FENCING REFER TO DETAIL ON DRG
- PROPOSED TIMBER POST AND RAIL FENCING REFER TO STANDARD
- PROPOSED 1.8m HIGH SECURITY FENCE
- PROPOSED 4.0m HIGH BALL STOP MESH FENCE
- PROPOSED TEMPORARY FENCE
- PROPOSED GATE
- PROPOSED STREET LIGHTING COLUMNS

www.semmms.info

STOCKPORT MANCHESTER CITY COUNCIL Cheshire East Council

Jim Malahan BSc, CEng, MICE
 SERVICE DIRECTOR, MAJOR PROJECTS

STOCKPORT HOUSE
 STOCKPORT, ST. ASKS
 TEL : 0161 474 4851
 FAX : 0161 474 4833

Job Title
A6 - MANCHESTER AIRPORT RELIEF ROAD

Drawing Title
PLANNING APPLICATION BLOCK PLANS PROPOSED SHEET 19

Drawn	Engineer	Checked	Approved
SEB/DP	SP	NH	AB
Date	Date	Date	Date
03.10.13	03.10.13	03.10.13	03.10.13
Size	Scale		
A1	1:1000		
SGC No.	Filename		
1007/3D/DF7/A6-MA/PABP/P/040		Revision	



This map is reproduced from Ordnance Survey material with the permission of Ordnance Survey on behalf of the Controller of Her Majesty's Stationery Office. © Crown copyright. Unauthorised reproduction infringes Crown copyright and may lead to prosecution or civil proceedings. Stockport Metropolitan Borough Council 100019571 2012

KEY

- PROPOSED CARPARKWAY
- PROPOSED CENTRAL RESERVE
- PROPOSED FOOTPATH
- PROPOSED 1.8m HIGH SECURITY FENCE
- PROPOSED 1.8m HIGH ACQUATIC FENCING REFER TO DETAIL ON SHEET 19
- PROPOSED 4.0m HIGH BALL STOP MESH FENCE
- PROPOSED TEMPORARY FENCE
- PROPOSED GATE
- PROPOSED STREET LIGHTING COLUMNS

FENCING LEGEND

- PROPOSED 1.8m HIGH ACQUATIC FENCING REFER TO DETAIL ON SHEET 19
- PROPOSED 1.8m HIGH SECURITY FENCE
- PROPOSED 4.0m HIGH BALL STOP MESH FENCE
- PROPOSED TEMPORARY FENCE
- PROPOSED GATE
- PROPOSED STREET LIGHTING COLUMNS

www.semms.info

STOCKPORT HOUSE
 STATIONERY 01 928 424 424
 SERVICE CENTRE, WALKER PROJECTS
 MAN 1 0161 474 433
 FAX 1 0161 474 4622

Job Title
A6 - MANCHESTER AIRPORT RELIEF ROAD

Drawing Title
PLANNING APPLICATION BLOCK PLANS PROPOSED SHEET 20

Drawn	Engineer	Checked	Approved
SEB/DP	SP	NH	AB
Date 03.10.13	Date 03.10.13	Date 03.10.13	Date 03.10.13
Size A1	Scale 1:1000		
SGC No.	Filename		
Drawing No. 1007/30/DF7/A6-MA/PABP/P/041	Revision		

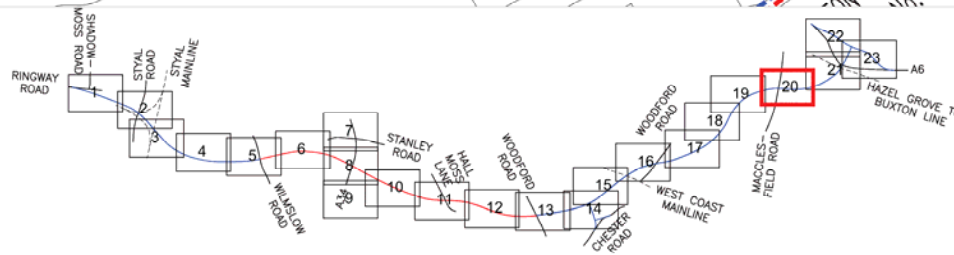

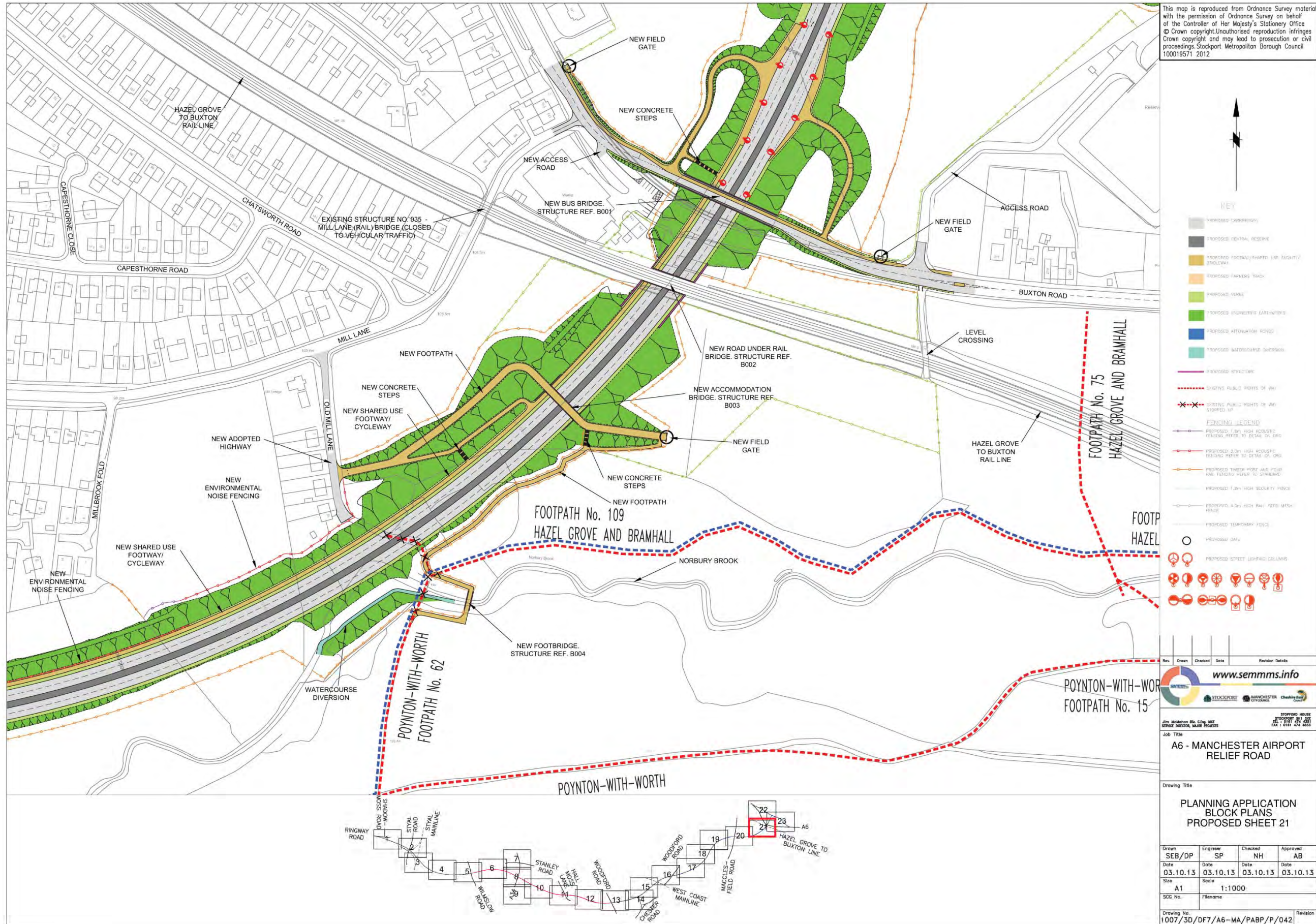

This map is reproduced from Ordnance Survey material with the permission of Ordnance Survey on behalf of the Controller of Her Majesty's Stationery Office. © Crown copyright. Unauthorised reproduction infringes Crown copyright and may lead to prosecution or civil proceedings. Stockport Metropolitan Borough Council 100019571 2012.

KEY

- PROPOSED CARPARK
- PROPOSED CENTRAL RESERVE
- PROPOSED FOOTWAY/SHARED USE FOOTWAY/BICYCLEWAY
- PROPOSED FARMERS TRACK
- PROPOSED VERGE
- PROPOSED ENGINEERS' GARDEN
- PROPOSED ATTENUATION ROCK
- PROPOSED WATERCOURSE DIVERSION
- PROPOSED STRUCTURE
- EXISTING PUBLIC RIGHTS OF WAY
- EXISTING PUBLIC RIGHTS TO BE AVOIDED

FENCING LEGEND

- PROPOSED 1.8m HIGH ACoustic FENCING REFER TO DETAIL ON DRG
- PROPOSED 3.0m HIGH ACoustic FENCING REFER TO DETAIL ON DRG
- PROPOSED TIMBER POST AND RAIL FENCING REFER TO STANDARD
- PROPOSED 1.8m HIGH SECURITY FENCE
- PROPOSED 1.8m HIGH BALL SEED MESH FENCE
- PROPOSED TEMPORARY FENCE
- PROPOSED GATE
- PROPOSED STREET LIGHTING COLUMN

Rev	Drawn	Checked	Date	Revision Details

www.semmms.info

STOCKPORT MANCHESTER CITY COUNCIL Cheshire East Council

John Moleham BSc, CEng, MICE
 SERVICE DIRECTOR, MAJOR PROJECTS

STOCKPORT HOICE
 TEL: 0161 275 2200
 FAX: 0161 474 4633

Job Title
A6 - MANCHESTER AIRPORT RELIEF ROAD

Drawing Title
PLANNING APPLICATION BLOCK PLANS PROPOSED SHEET 21

Drawn	Engineer	Checked	Approved
SEB/DP	SP	NH	AB
Date	Date	Date	Date
03.10.13	03.10.13	03.10.13	03.10.13
Size	Scale		
A1	1:1000		
SOC No.	Filename		
Drawing No.	Revision		
1007/30/DF7/A6-MA/PABP/P/042			



This map is reproduced from Ordnance Survey material with the permission of Ordnance Survey on behalf of the Controller of Her Majesty's Stationery Office © Crown copyright. Unauthorised reproduction infringes Crown copyright and may lead to prosecution or civil proceedings. Stockport Metropolitan Borough Council 100019571 2012

KEY

- PROPOSED ASPHALT
- PROPOSED GRASS
- PROPOSED FOOTWAY/SHARED USE FACILITY/BOULEVARD
- PROPOSED FARMERS TRACK
- PROPOSED FENCE
- PROPOSED ENGINEERED LATHWORKS
- PROPOSED ATTENUATION POND
- PROPOSED WATERCOURSE DIVERSION
- PROPOSED STRUCTURE
- EXISTING PUBLIC RIGHTS OF WAY
- EXISTING PUBLIC RIGHTS OF WAY STOPPED UP
- FENCING (LEGEND)
- PROPOSED 1.8m HIGH ACUSTIC FENCING REFER TO DETAIL 04A DRG
- PROPOSED 3.0m HIGH ACUSTIC FENCING REFER TO DETAIL 04B DRG
- PROPOSED TAMBER POST AND RAIL FENCING REFER TO STAIRCASE
- PROPOSED 1.8m HIGH SECURITY FENCE
- PROPOSED 4.0m HIGH BRILL STOP FENCE
- PROPOSED TEMPORARY FENCE
- PROPOSED GATE
- PROPOSED STREET LIGHTING COLUMN
- PROPOSED STREET LIGHTING COLUMN
- PROPOSED STREET LIGHTING COLUMN
- PROPOSED STREET LIGHTING COLUMN
- PROPOSED STREET LIGHTING COLUMN
- PROPOSED STREET LIGHTING COLUMN
- PROPOSED STREET LIGHTING COLUMN
- PROPOSED STREET LIGHTING COLUMN

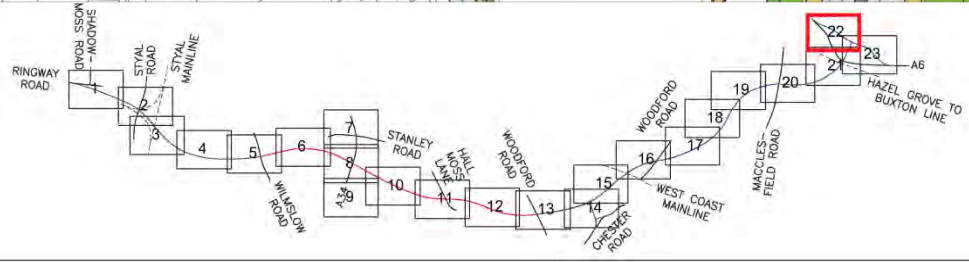

Rev	Drawn	Checked	Date	Revision Details
www.semms.info				
Job Title A6 - MANCHESTER AIRPORT RELIEF ROAD				
Drawing Title PLANNING APPLICATION BLOCK PLANS PROPOSED SHEET 22				
Drawn	Engineer	Checked	Approved	
SEB/DP	SP	NH	AB	
Date	Date	Date	Date	
03.10.13	03.10.13	03.10.13	03.10.13	
Size	Scale			
A1	1:1000			
SGC No.	Filename			
Drawing No.	Revision			
1007/30/DF7/A6-MA/PABP/P/043				

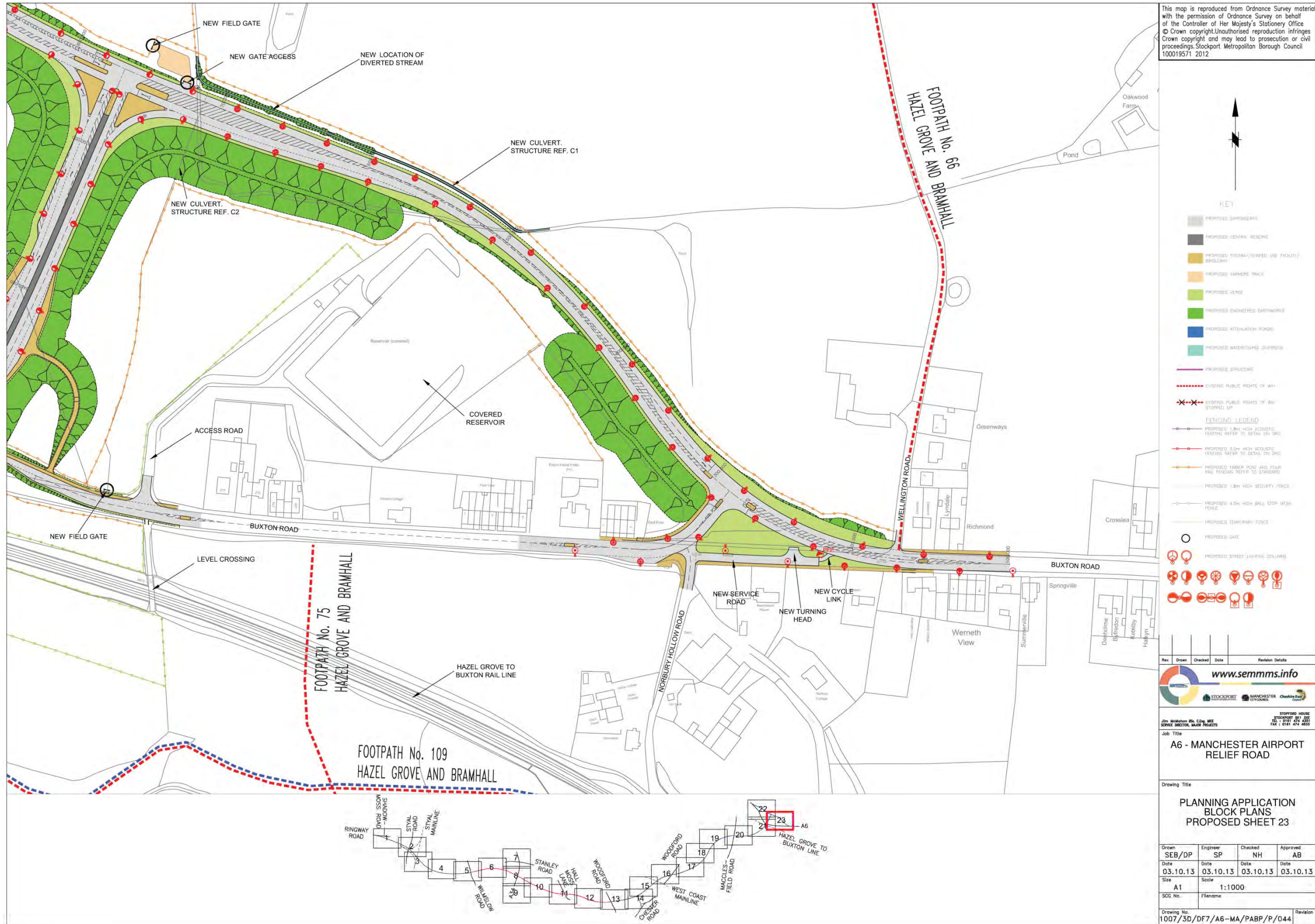

This map is reproduced from Ordnance Survey material with the permission of Ordnance Survey on behalf of the Controller of Her Majesty's Stationery Office. © Crown copyright. Unauthorised reproduction infringes Crown copyright and may lead to prosecution or civil proceedings. Stockport Metropolitan Borough Council 100019571 2012

KEY

- PROPOSED GARDENWAY
- PROPOSED GENERAL RESERVE
- PROPOSED FOOTWAY/SHARED USE FACILITY/BROOKWAY
- PROPOSED FARMERS TRACK
- PROPOSED VERGE
- PROPOSED ENGINEERED EARTHWORKS
- PROPOSED ATTENUATION POND
- PROPOSED WATERCOURSE DIVERSION
- PROPOSED STRUCTURE
- EXISTING PUBLIC RIGHTS OF WAY
- EXISTING PUBLIC RIGHTS OF WAY STOPPED UP

FENCING LEGEND

- PROPOSED 1.8m HIGH ACQUISITION FENCING REFER TO DETAIL ON S10
- PROPOSED 3.0m HIGH ACQUISITION FENCING REFER TO DETAIL ON S10
- PROPOSED TAMBER POST AND FOUR RAIL FENCING REFER TO STANDARD
- PROPOSED 1.8m HIGH SECURITY FENCE
- PROPOSED 4.0m HIGH BALL STOP VESH FENCE
- PROPOSED TEMPORARY FENCE
- PROPOSED GATE
- PROPOSED STREET LIGHTING (SIGNAL)

www.semmms.info
 STOCKPORT MANCHESTER CITY COUNCIL Cheshire East Council

Job Title
A6 - MANCHESTER AIRPORT RELIEF ROAD

Drawing Title
PLANNING APPLICATION BLOCK PLANS PROPOSED SHEET 23

Drawn	Engineer	Checked	Approved
SEB/DP	SP	NH	AB
Date 03.10.13	Date 03.10.13	Date 03.10.13	Date 03.10.13
Size A1	Scale 1:1000		
S02 No.	Filename		
Drawing No. 1007/30/DF7/A6-MA/PABP/P/044	Revision		

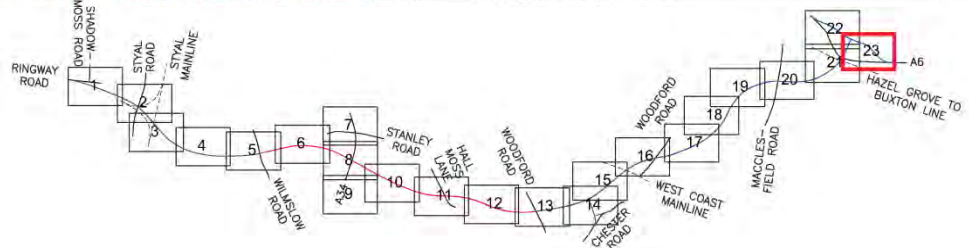

Appendix B

SEMMMS Footpath Monitoring Report

ASSOCIATION OF GREATER MANCHESTER AUTHORITIES

GREATER MANCHESTER TRANSPORTATION UNIT

SEMMMS Footpath Monitoring Report

GMTU Report 1621

July 2010

Summary

This report is intended to provide an analysis of the current usage of footpaths that would cross, or be affected by, the planned extensions to the A555 (Manchester Airport Eastern Link Road) as part of the South East Manchester Multi Modal Scheme.

The majority of people using the footpaths were adult pedestrians. The number of people using each footpath varied greatly, with half the people counted in the eastern end of the planned scheme at Site 4 and a third of the people using the footpaths at the western end at Site 13B. To the east, recreational, dog walking and shopping were most popular reasons for using the footpaths. At the western end, going to work, convenience and recreational use were the main reasons given for using the footpaths. A quarter of people interviewed use the footpaths daily and 79% use them at least once a week.

Ally Collins

July 2010

GMTU, Heron House, 47 Lloyd St, Manchester M2 5LE

Tel: 0161 455 2112
gmtu@manchester.gov.uk

C O N T E N T S

	Page
1. Introduction	2
2. Sites	3
3. Link and Turn Count Results	6
4. Interview Results	10
Appendix 1 – Location Maps	15
Appendix 2 – Interview Data Tables	29

1. Introduction

- 1.1 The South East Manchester Multi Modal Scheme (SEMMMS) aims to improve the road network in South East Manchester. This part of the scheme involves extending the A555 Manchester Airport Eastern Link Road to link Manchester Airport with the A6 between Hazel Grove and High Lane. The A555 currently runs from Handforth to Bramhall and would form the middle section of the proposed route.
- 1.2 As the planned extensions would run through countryside, a number of public footpaths and 'Rights of Way' will be severed. GMTU were therefore commissioned to undertake surveys to identify the number of people likely to be affected by this so that the need (or otherwise) for action to mitigate any severance could be identified.
- 1.3 Counts of anyone using the footpaths were recorded by category - pedestrians, horse riders, cyclists & mobility impaired (buggies, mobility scooters/wheelchairs), for both adults and children.
- 1.4 In order to obtain accurate data for an average day, surveys were undertaken on 1 weekday, 1 Saturday and 1 Sunday. The surveys were carried out in June and early July, finishing before the school holidays. Particular care was taken to ensure that count dates did not clash with any local events which may have impacted on the reliability of the data.
- 1.5 Surveys were carried out continuously from 0700 to 2100. The surveys were all carried out manually operating two shifts per day, the first shift from 0700 to 1400 and the second from 1400 to 2100.
- 1.6 The majority of counts were link counts. However, where site locations were at junctions, turning counts were carried out. For analysis purposes, the sites were split into two groups. Sites 1 to 10 are located to the east of the existing section of road (A555 Manchester Airport Eastern Link Road) and sites 11-16 lie to the west.
- 1.7 In order to obtain additional information, interviews were also carried out asking the following questions:
 - Where are you travelling from?
 - Where are you travelling to?
 - Why are you using the footpath?
 - How often do you use the footpath?

2. Sites

2.1 Table 1 details the sites where surveys were undertaken, the count type and the survey dates. Figures 1 and 2 show the site locations for the east and west areas respectively. A detailed map for each survey site can be found in Appendix 1.

Table 1 - Site Locations and Survey Schedule				Dates		
Area	Site	Count Type	Location	Fri	Sat	Sun
East	1	Link	Toucan crossing on the A6 Buxton Rd in Hazel Grove	25-Jun	19-Jun	20-Jun
	2	Link	Road into Hazel Grove Golf Club, at bridge over the stream	25-Jun	19-Jun	20-Jun
	3	Link	Footpath 76 at the bottom of Old Mill Lane	25-Jun	19-Jun	20-Jun
	4	Link	A523 Macclesfield Rd, just north of the car park entrance	25-Jun	19-Jun	20-Jun
	5	Link	Footpath 3 at the end of Mill Hill Hollow	25-Jun	19-Jun	20-Jun
	6	Link	Footpath 37, just north of Park House Farm	25-Jun	19-Jun	20-Jun
	7	Link	Footpath 31 at the gate/footpath sign on Woodford Rd	25-Jun	19-Jun	20-Jun
	8	Turn	Footpath 21 on Woodford Rd	25-Jun	19-Jun	20-Jun
	9	Link	Footpath 19 off Woodford Rd, which starts opposite house no.32.	25-Jun	19-Jun	20-Jun
	10	Turn	Intersection of footpaths 14a, 15 and 16	02-Jul	26-Jun	27-Jun
West	11	Turn	Intersection of footpaths northwest of The Grange	02-Jul	26-Jun	27-Jun
	12	Link	Footbridge over the railway at the back of Beech Farm in Styal	02-Jul	26-Jun	27-Jun
	13a	Link	Entry to footpath which accesses footbridge over the railway on Styal Rd	02-Jul	26-Jun	27-Jun
	13b	Link	Hollin Lane approximately 100m north of Moss Lane	02-Jul	26-Jun	27-Jun
	14	Turn	Woodhouse Lane south of Dentdale Walk	02-Jul	26-Jun	27-Jun
	15	Link	Railway Bridge south of Ringway Rd West	02-Jul	26-Jun	27-Jun
	16	Link	Thorley Lane just south of Bailey Lane	02-Jul	26-Jun	27-Jun

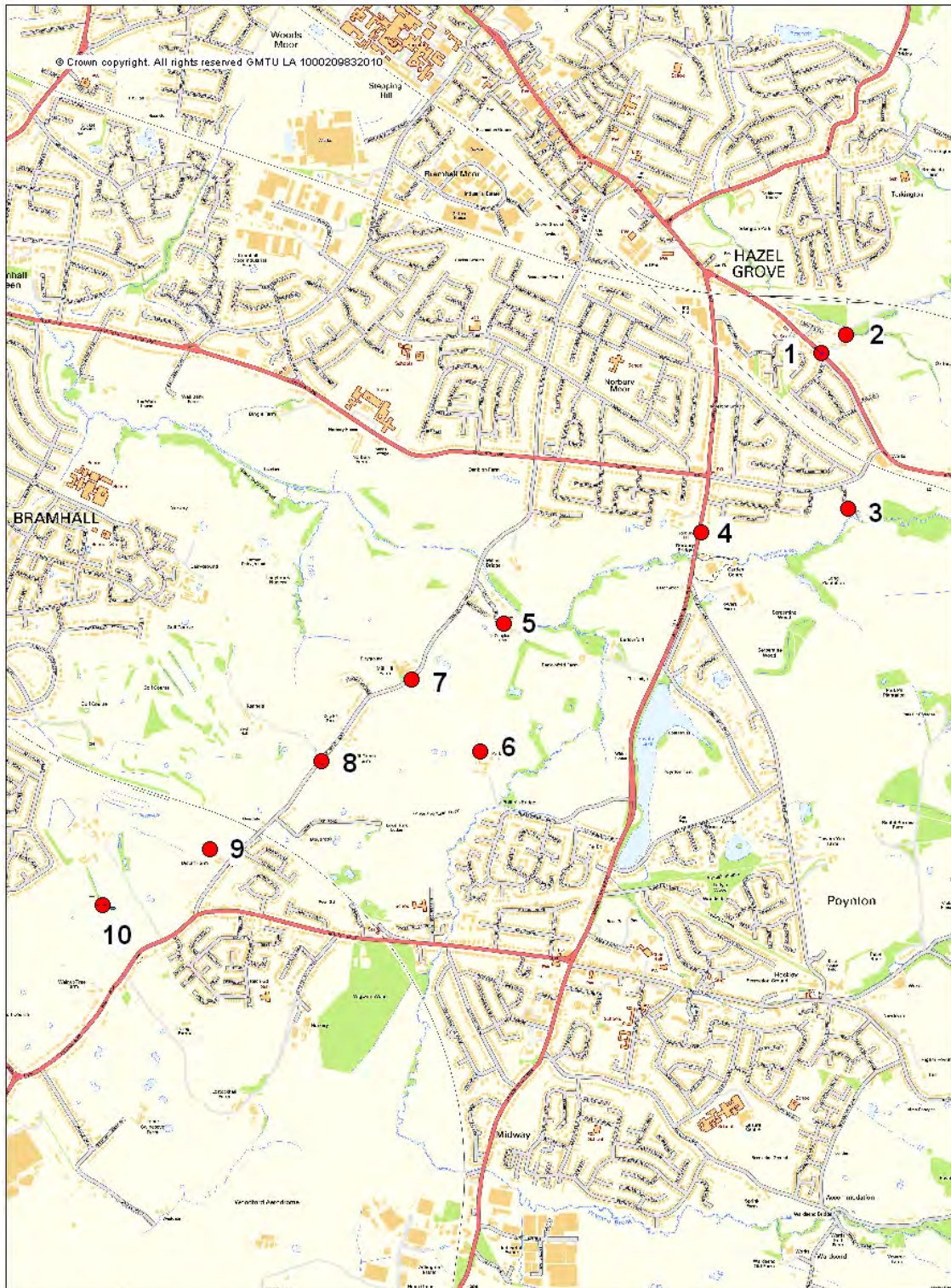

SEMMMS Pedestrian/Cycle/Equestrian Counts		Location: East Area, Sites 1-10	
GMTU SALISBURY HOUSE GRANBY ROW MANCHESTER, M1 7AH	Figure 1		
	Survey Day/Date : As per schedule		Survey Period: 0700-2100

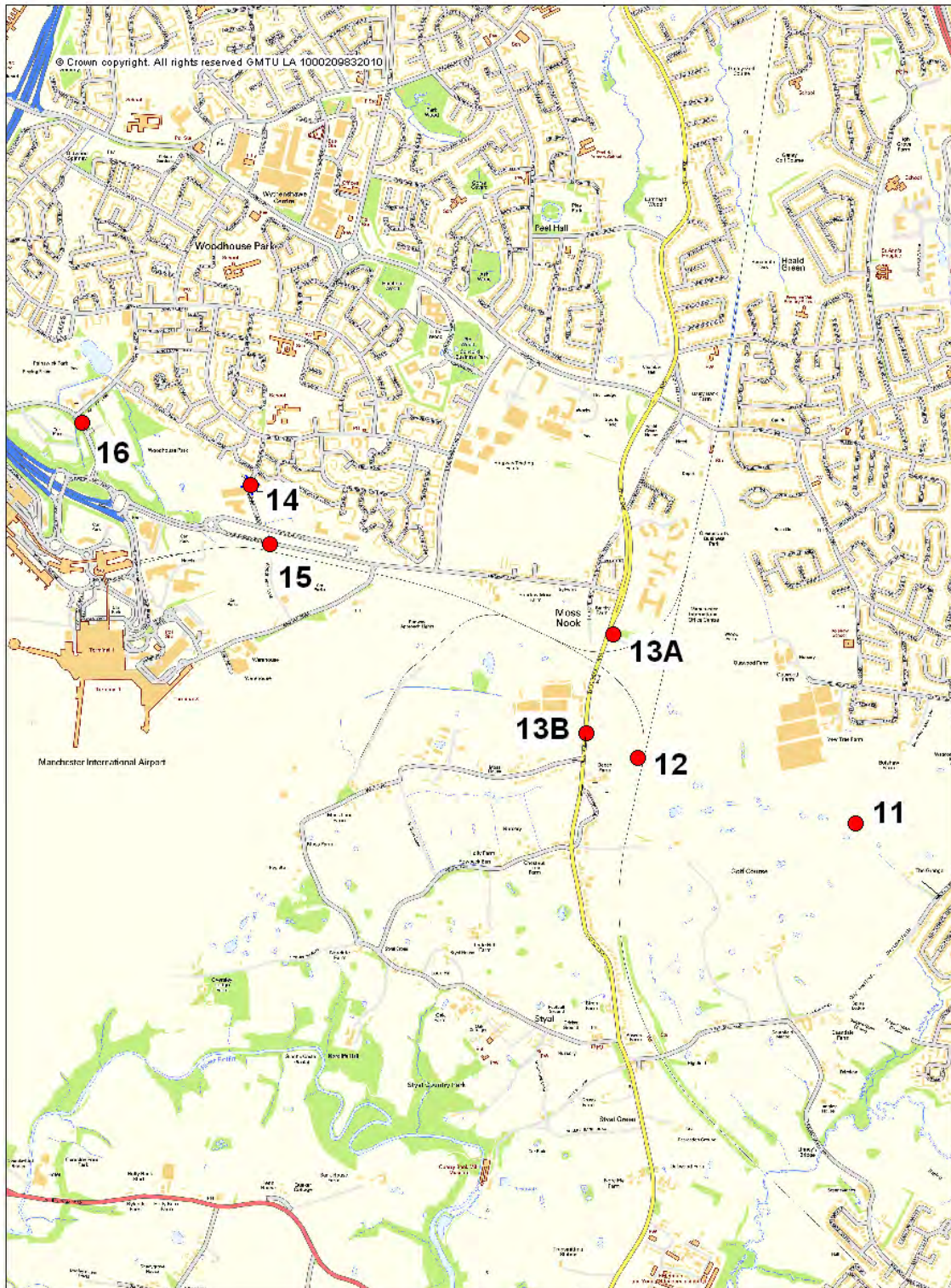

SEMMMS Pedestrian/Cycle/Equestrian Counts		Location: West Area, Sites 11-16	
GMTU SALISBURY HOUSE GRANBY ROW MANCHESTER, M1 7AH	Figure 2		
	Survey Day/Date : As per schedule		Survey Period: 0700-2100

3 Link and Turn Count Results

3.1 Figure 3 shows the number of adults and children using the footpaths, grouped by pedestrian, cyclist, horse rider and buggy/wheelchair users.

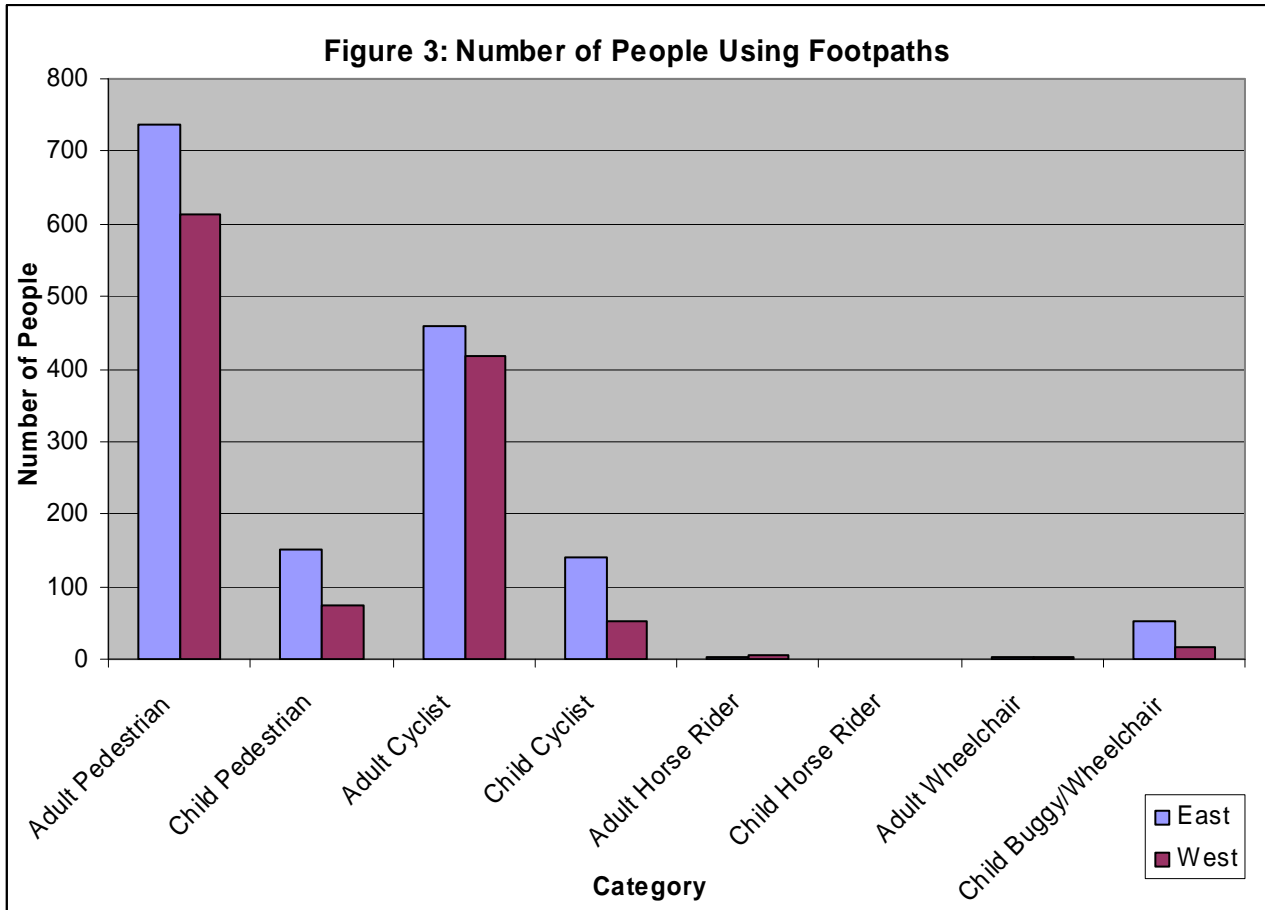

3.2 The majority of people using the footpaths were adult pedestrians, followed by adult cyclists. Although there were far more adults than children, the number of children counted were equally split between pedestrians and cyclists.

3.3 Table 2 presents the data for the link and turns counts in the east area.

Table 2 East Link and Turn Count Results											
East Links		Pedestrian		Cyclist		Horse Rider		Buggy/Wheelchair		Total	%
Site	Direction	Adult	Child	Adult	Child	Adult	Child	Adult	Child		
1	NE	49	9	2	5				6	71	5%
	SW	46	7	2	7				7	69	5%
	Total	95	16	4	12				13	140	11%
2	N	30	2	3	6					41	3%
	S	26	3	10	1					40	3%
	Total	56	5	13	7					81	6%
3	N	70	31	7	27					135	10%
	S	68	24	8	33			2	4	139	11%
	Total	138	55	15	60			2	4	274	21%
4	N	161	33	147	21				21	383	29%
	S	151	34	159	15				13	372	28%
	Total	312	67	306	36				34	755	57%
5	NW	23	2							25	2%
	SE	27	1	1						29	2%
	Total	50	3	1						54	4%
6	N	3			1					4	0%
	S	1								1	0%
	Total	4			1					5	0%
7	N	2								2	0%
	S	3								3	0%
	Total	5								5	0%
9	E									0	0%
	W									0	0%
	Total									0	0%
Link Total		660	146	339	116			2	51	1314	100%
%		50%	11%	26%	9%	0%	0%	0%	4%	100%	
East Turns		Pedestrian		Cyclist		Horse Rider		Buggy/Wheelchair		Total	%
Site	Direction	Adult	Child	Adult	Child	Adult	Child	Adult	Child		
8	1	10	1	13	4					28	12%
	2	11		53	11					75	33%
	3	6	1							7	3%
	4	17	2	54	10	2				85	37%
	Total	44	4	120	25	2				195	85%
10	1	29	1							30	13%
	2									0	0%
	3	5								5	2%
	Total	34	1							35	15%
Turn Total		78	5	120	25	2				230	100%
%		34%	2%	52%	11%	1%	0%	0%	0%	100%	
EAST TOTAL		738	151	459	141	2	0	2	51	1544	
%		48%	10%	30%	9%	0%	0%	0%	3%	100%	

3.4 Key observations for the eastern end (sites 1-10) are as follows:

- A total of 1544 people were counted.
- Site 4 was the busiest site, with almost half of the people counted here.
- Sites 6, 7 and 9 were the least used, with 5, 5 and 0 people counted respectively.
- Of the link counts, 50% were adult pedestrians and 26% were adult cyclists.
- Site 4 was particularly popular for cyclists, with 342 adult and child cyclists out of a total of 455 surveyed across all the eastern sites.
- Site 8 had 3 times as many cyclists as pedestrians.
- 2 horse riders were counted, 0.1% of the total footpath traffic.
- Children in buggys made up 4% of the people counted.
- 2 wheelchair users were counted in the east area.

3.3 Table 3 presents the data for the link and turns counts in the west area.

Table 3 West Link and Turn Count Results											
West Links		Pedestrian		Cyclist		Horse Rider		Buggy/Wheelchair		Total	%
Site	Direction	Adult	Child	Adult	Child	Adult	Child	Adult	Child		
12	E	2								2	0%
	W	8								8	1%
	Total	10								10	1%
13A	E	5		1						6	1%
	W	2								2	0%
	Total	7		1						8	1%
13B	N	59	5	111	12	2		1	1	191	22%
	S	47	8	120	22	2			1	200	23%
	Total	106	13	231	34	4		1	2	391	46%
15	N	35	7	11	1				1	55	6%
	S	40	5	11	1				2	59	7%
	Total	75	12	22	2				3	114	13%
16	N	88	5	53	1			1	2	150	18%
	S	104	6	65	3			1	4	183	21%
	Total	192	11	118	4			2	6	333	39%
Links Total		390	36	372	40	4		3	11	856	100%
%		46%	4%	43%	5%	0%	0%	0%	1%	100%	
West Turns		Pedestrian		Cyclist		Horse Rider		Buggy/Wheelchair		Total	%
Site	Direction	Adult	Child	Adult	Child	Adult	Child	Adult	Child		
11	1	32	2							34	11%
	2	17	1	1		1				20	6%
	3	8	2							10	3%
	Total	57	5	1		1				64	20%
14	1	76	16	20	5				1	118	37%
	2									0	0%
	3	89	16	26	6				4	141	44%
	Total	165	32	46	11				5	259	80%
Turns Total		222	37	47	11	1			5	323	100%
%		69%	11%	15%	3%	0%	0%	0%	2%	100%	
WEST TOTAL		612	73	419	51	5	0	3	16	1179	
%		52%	6%	36%	4%	0%	0%	0%	1%	100%	

3.4 Key observations for the western end (sites 11-16) are as follows:

- A total of 1179 people were counted.
- The busiest link count was at site 13B, where a third of people were counted.
- Site 14 was the busiest turn count, with 259 people (22%) using this junction.
- Fewer than 2% of people counted were at sites 12 and 13A (10 people and 12 people respectively).
- At the link count sites, there was a fairly even split between pedestrians and cyclists, with 50% of people walking and 48% cycling.
- The turn count sites had more than 4 times as many pedestrians as cyclists.
- The majority of cyclists (82%) were passing through sites 13B and 16 (265 and 122 cyclists respectively).
- 5 horse riders and 3 wheelchair users were counted.
- Only 16 children in buggies were counted, compared with 51 at the eastern end.

4 Interview Results

4.1 757 interviews were carried out at the eastern end and 1265 at the western end.

Of those conducted in the east, three quarters were with individuals and a quarter with a member of a group. The majority of interviews (61%) were during the daytime (10:00-17:00), with 16% early (07:00-10:00) and 23% during the evening (17:00-21:00). 16% of people on the footpaths at the eastern end were not interviewed because they were either children, missed or avoided by the surveyor. 14% of people asked refused to answer.

At the western end, 77% of interviews were held with individuals and the remainder with someone travelling in a group. The proportion of interviews carried out across the day is similar to the eastern end, with 20% early, 56% during the daytime and 24% in the evening. 23% were not interviewed as they were either children, avoided by the surveyor or were missed. A total of 18% refused the survey when asked.

Tables showing these results in detail can be found in Appendix 2. Interview responses are listed in full in Appendix 3.

4.2 Table 4 and Figure 4 show the reasons given by interviewees for using the footpaths at the eastern end.

Table 4 Reason for Using Path in East Area	Site									Total	%
	1	2	3	4	5	7	8	9	10		
Recreational	22	23	25	142	8	3	9	2	7	241	47%
Dog walking	7	12	44	20	3	4	5		20	115	22%
Shopping	5	1	1	55	1					63	12%
Going to work	6	2	1	35	1					45	9%
Best route to destination	13	2	4	12	1					32	6%
Access to Garden Centre				7	1					8	2%
No other transport		1		4	1					6	1%
Going to train station				3						3	1%
Going to church	1			1						2	0%
Going to bus stop				2						2	0%
Total	54	41	75	281	16	7	14	2	27	517	100%

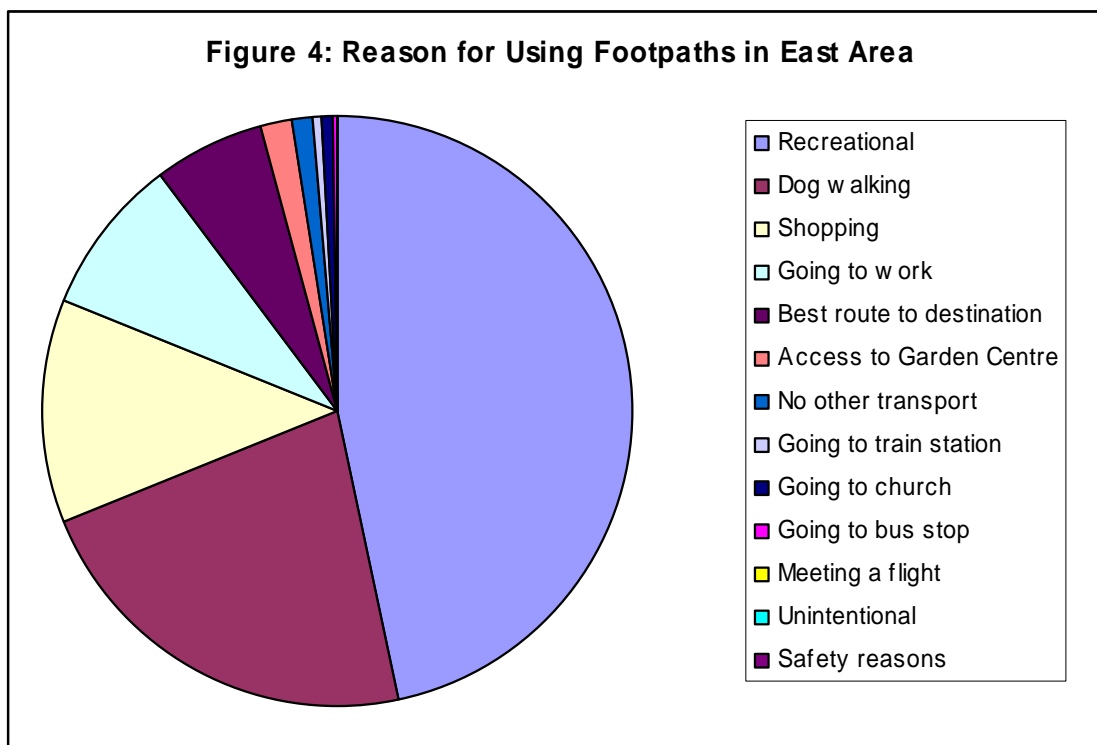

4.3 Key findings are as follows:

- 47% of people interviewed were using the footpaths for recreational purposes. Other popular responses included dog walking (22%) and shopping (12%).
- Site 1 appears to be a particularly convenient route. 24% of interviewees were using the footpath because it was the best route to their destination, compared with an average of 6% for this reason across the 10 eastern sites.
- Sites 3 and 10 are popular areas for dog walking, with 59% and 74% of people using the footpath for this reason.

4.4 Table 5 and Figure 5 show the reasons given by interviewees for using the footpaths at the western end.

Table 5 Reason for Using Path in West Area	Site							Total	%
	11	12	13A	13B	14	15	16		
Going to work				13	47	17	143	220	30%
Best route to destination	2	1		17	42	26	122	210	29%
Recreational	10	6	6	98	19	24	34	197	27%
Dog walking	31	2	2	12	31		4	82	11%
Shopping				2	1		2	5	1%
Going to train station					1		3	4	1%
Meeting a flight							3	3	0%
No other transport				2				2	0%
Going to bus stop				1				1	0%
Unintentional							1	1	0%
Safety reasons							1	1	0%
Total	43	9	8	145	141	67	313	726	100%

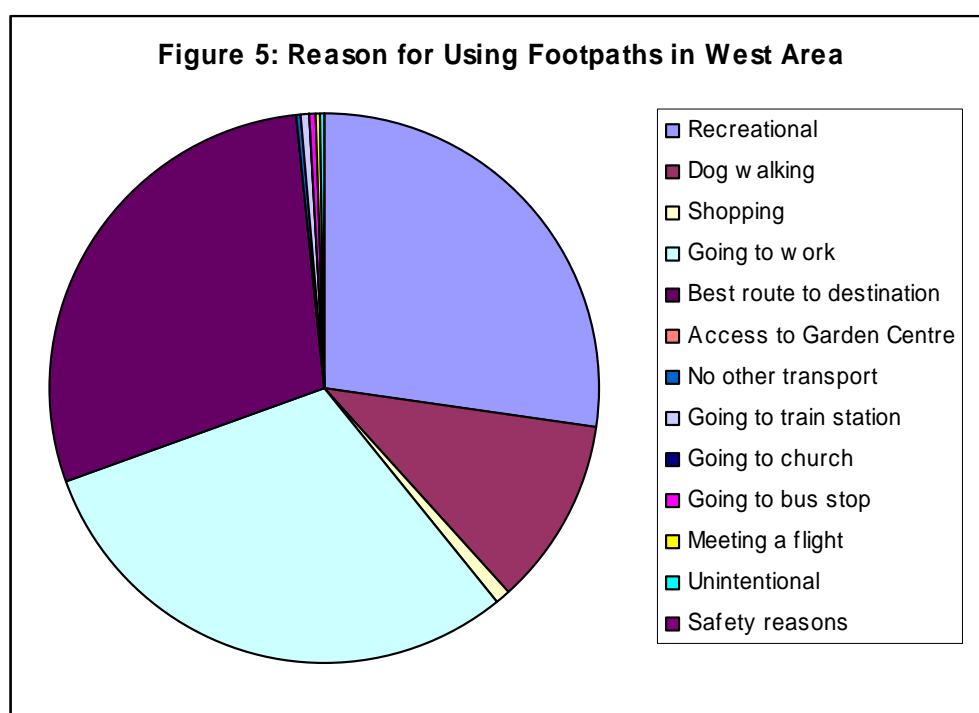

4.5 Key findings are as follows:

- The 3 main reasons for using the footpaths to the west were going to work (30%), the best route to destination (29%) and recreational use (27%).
- Other than 11% dog walking in the area, very few people used the footpath for any other reasons.
- Nearly 46% of people interviewed at site 16 used the footpath to get to work and 40% because it was the best route to their destination, showing a heavy emphasis on using this footpath for purpose rather than leisure.

4.6 Figure 6 gives an indication of how often interviewees use the footpaths both at the eastern and the western ends.

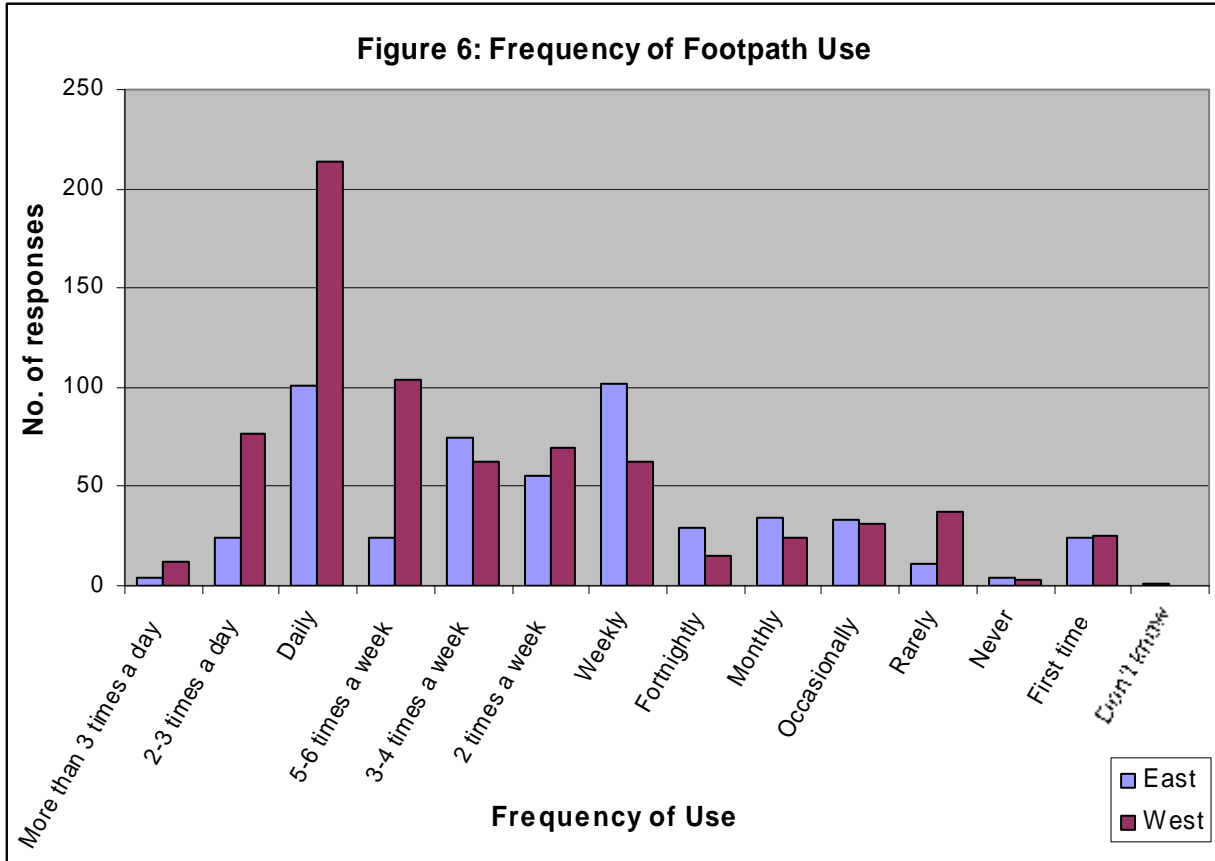

4.7 From comparing the frequency of use in the east and west areas, it is notable that those using the footpaths in the west rely on them on a more regular basis than those in the east. However, for both areas, the vast majority of interviewees use the footpaths at least weekly.

4.8 Table 6 shows the frequency of use of the footpaths in the east area.

Table 6 Frequency of Use in the East Area	Site									Total	%
	1	2	3	4	5	7	8	9	10		
More than 3 times a day	1			1	2					4	1%
2-3 times a day	8	2	6	3		2		1	2	24	5%
Daily	8	8	30	42		1	4		8	101	20%
5-6 times a week	3	2	6	12					1	24	5%
3-4 times a week	13	5	6	41	2	1		1	6	75	15%
2 times a week	6	3	1	35	2	1	4		3	55	11%
Weekly	2	7	11	69	4	1	4		4	102	20%
Fortnightly	2	3	4	18	2					29	6%
Monthly	3	1	2	26					2	34	7%
Occasionally	1	6	1	22	2		1			33	6%
Rarely	2		2	6			1			11	2%
Never	2		1	1						4	1%
First time	3	4	5	7	1	1	1	1	1	24	5%
Don't know					1					1	0%
Total	53	41	75	282	14	7	15	3	27	517	100%

4.9 Key findings are as follows:

- 20% of people interviewed use the footpaths daily.
- Three quarters of interviewees use the footpaths at least once a week.

4.10 Table 7 shows how often interviewees use the footpaths in the west area.

Table 7 Frequency of Use in the West Area	Site							Total	%
	11	12	13A	13B	14	15	16		
More than 3 times a day					5	4	3	12	2%
2-3 times a day	6		2	4	43	7	15	77	11%
Daily	15	1		7	29	11	151	214	30%
5-6 times a week	4			20	20	8	52	104	14%
3-4 times a week	5	2	2	21	9	4	19	62	9%
2 times a week	2			22	15	12	19	70	10%
Weekly	3	1		21	8	6	24	63	9%
Fortnightly		1		8	2	2	2	15	2%
Monthly	1	3		13	2	2	3	24	3%
Occasionally	5			4	5	7	10	31	4%
Rarely		1		16	4	4	12	37	5%
Never							3	3	0%
First time			4	9	1	1	10	25	3%
Total	41	9	8	145	138	64	320	725	100%

4.11 Key findings are as follows:

- 30% of interviewees use the footpaths daily. This was the most popular response.
- 83% use the footpaths at least once a week, 6% more than in the east area.

Appendix 1 – Location Maps

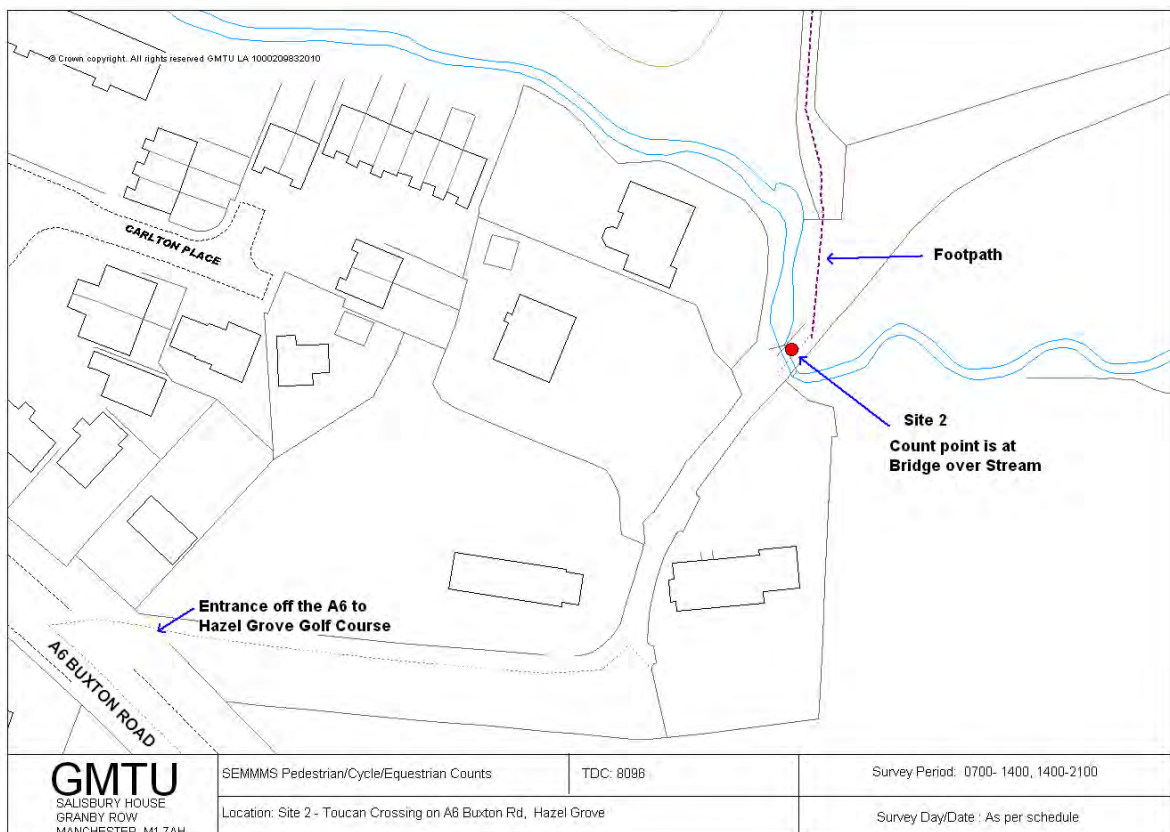
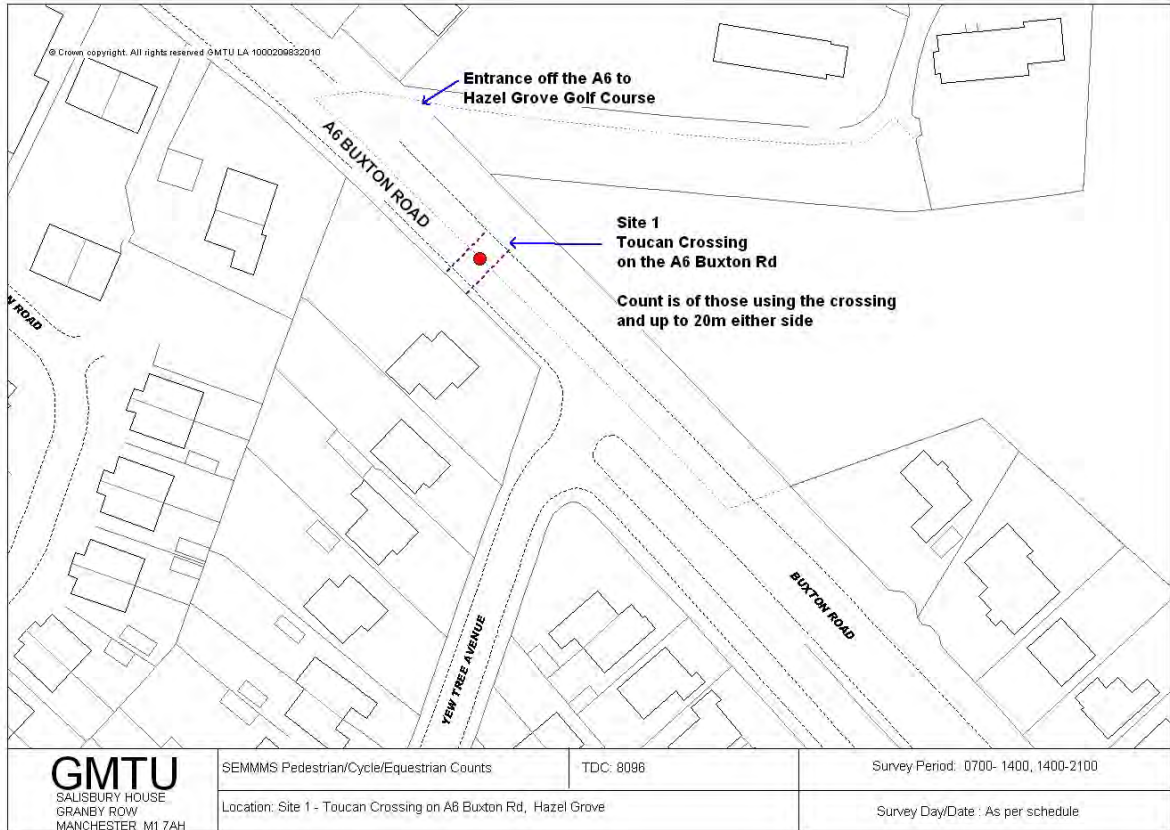



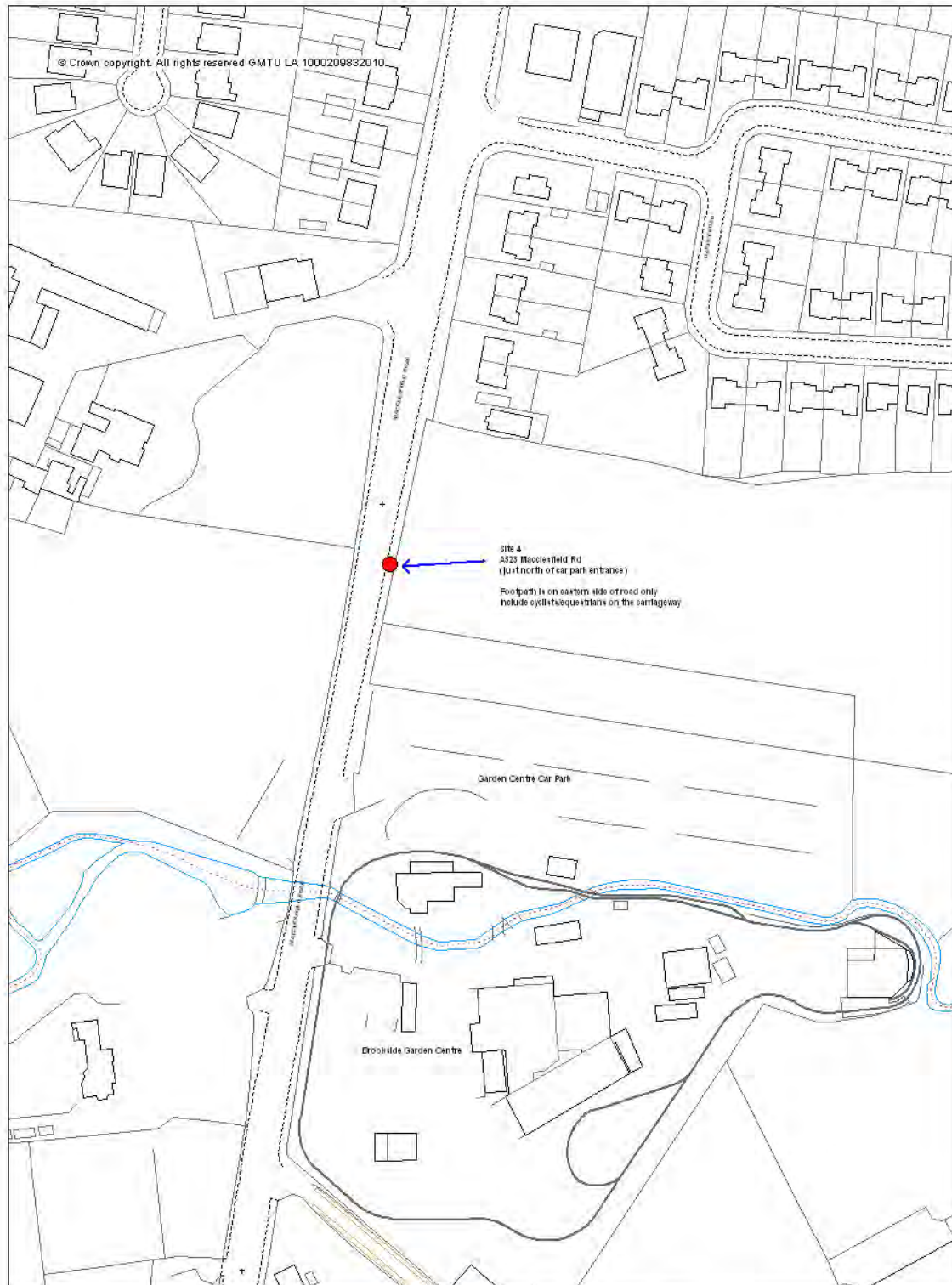

SEMMMS Pedestrian/Cycle/Equestrian Counts		Survey Day/Date : As per schedule	
GMTU SALISBURY HOUSE GRANBY ROW MANCHESTER, M1 7AH	Location: Site 4 - A523 Macclesfield Rd, nr Brookside Garden Centre, Hazel Grove		
	TDC: 8096	Survey Period: 0700- 1400, 1400-2100	

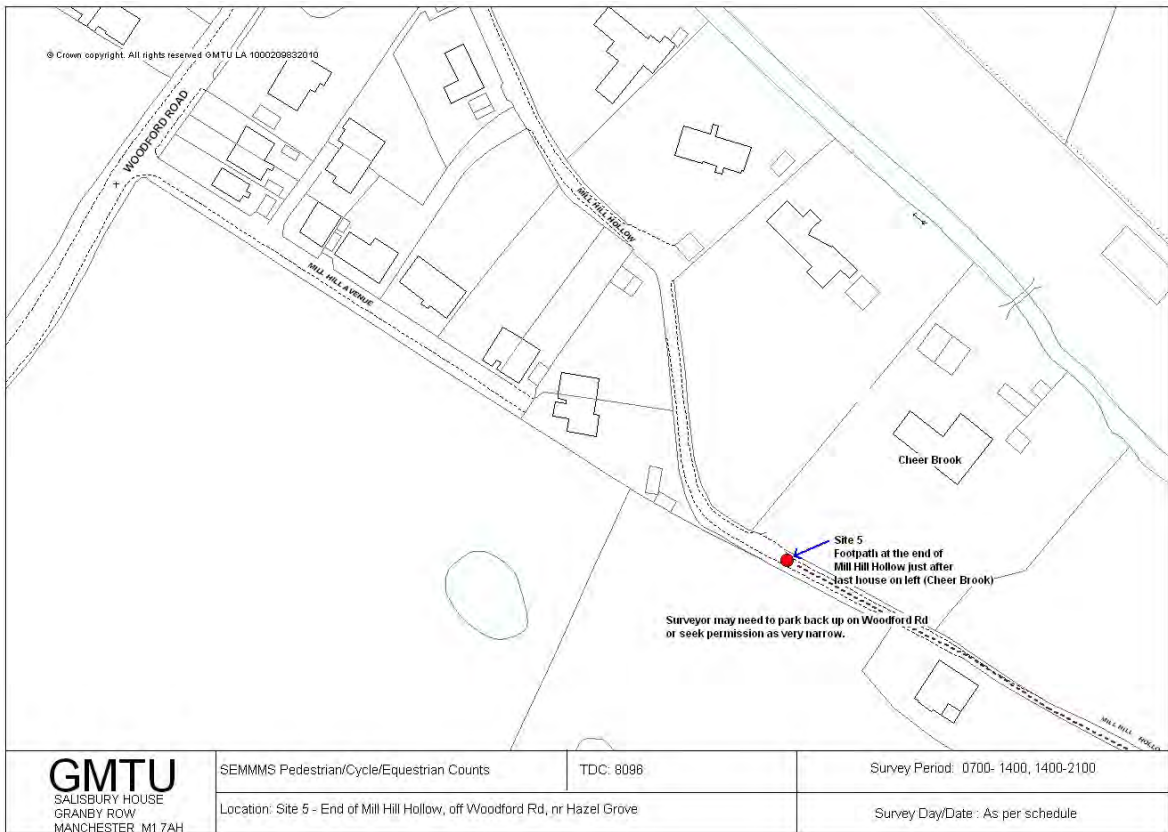



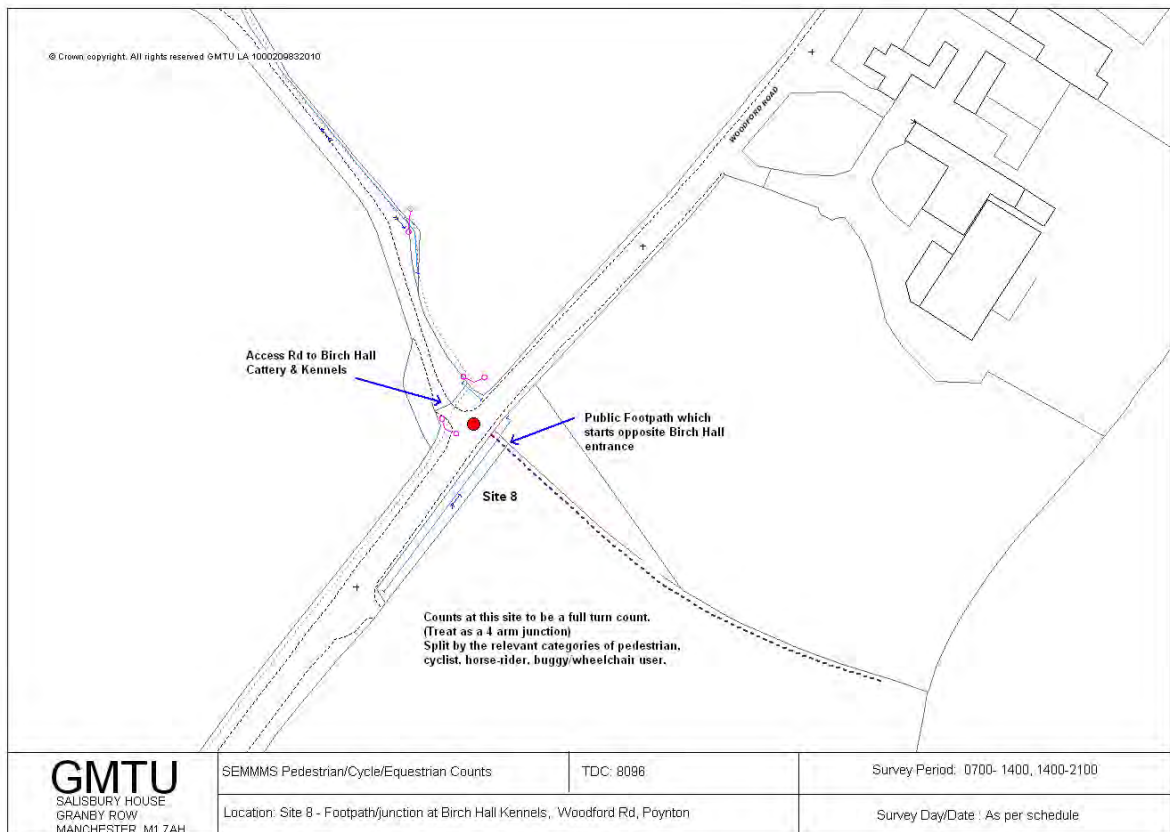
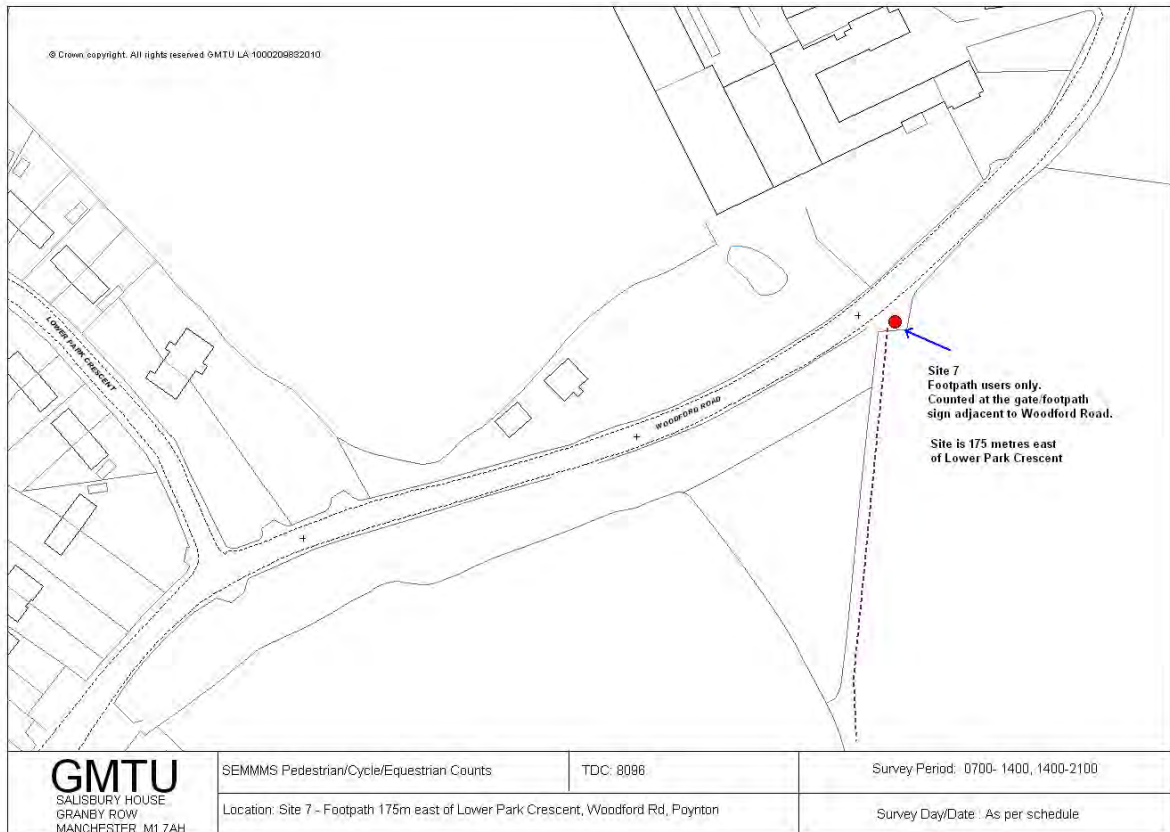

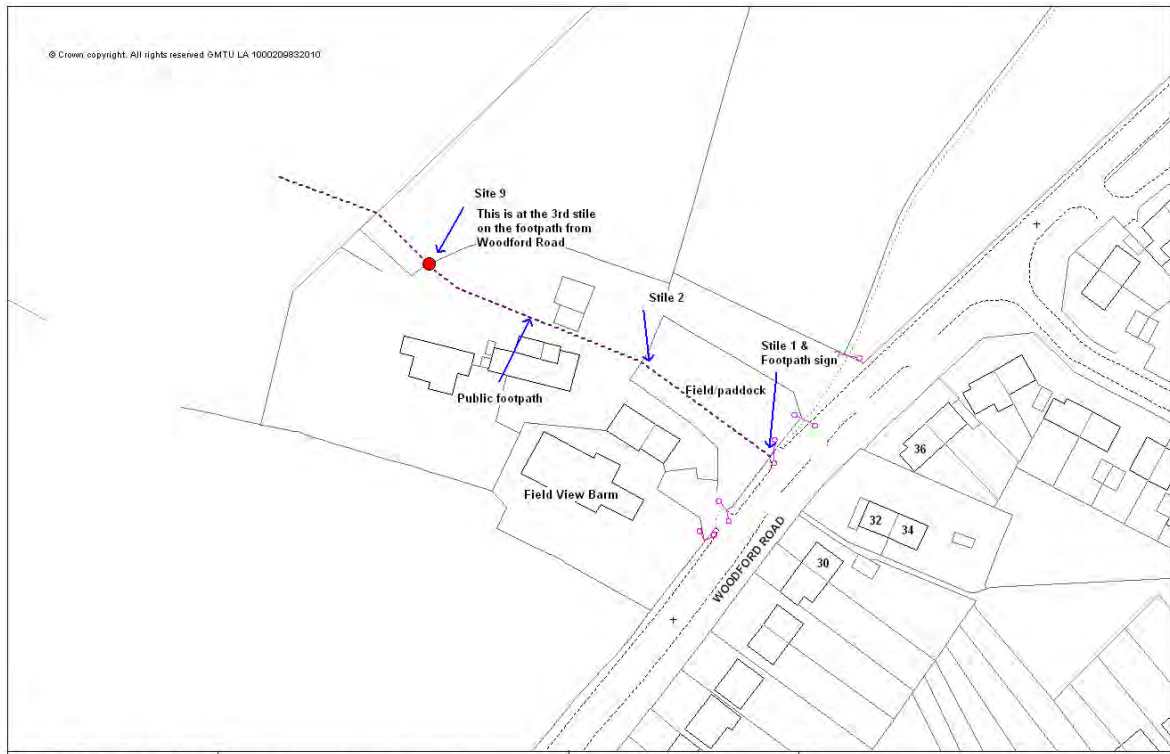

GMTU SALISBURY HOUSE GRANBY ROW MANCHESTER M1 7AH	SEMMS Pedestrian/Cycle/Equestrian Counts	TDC: 8086	Survey Period: 0700- 1400, 1400-2100
	Location: Site 9 - Footpath off Woodford Rd, Poynton		Survey Day/Date: As per schedule

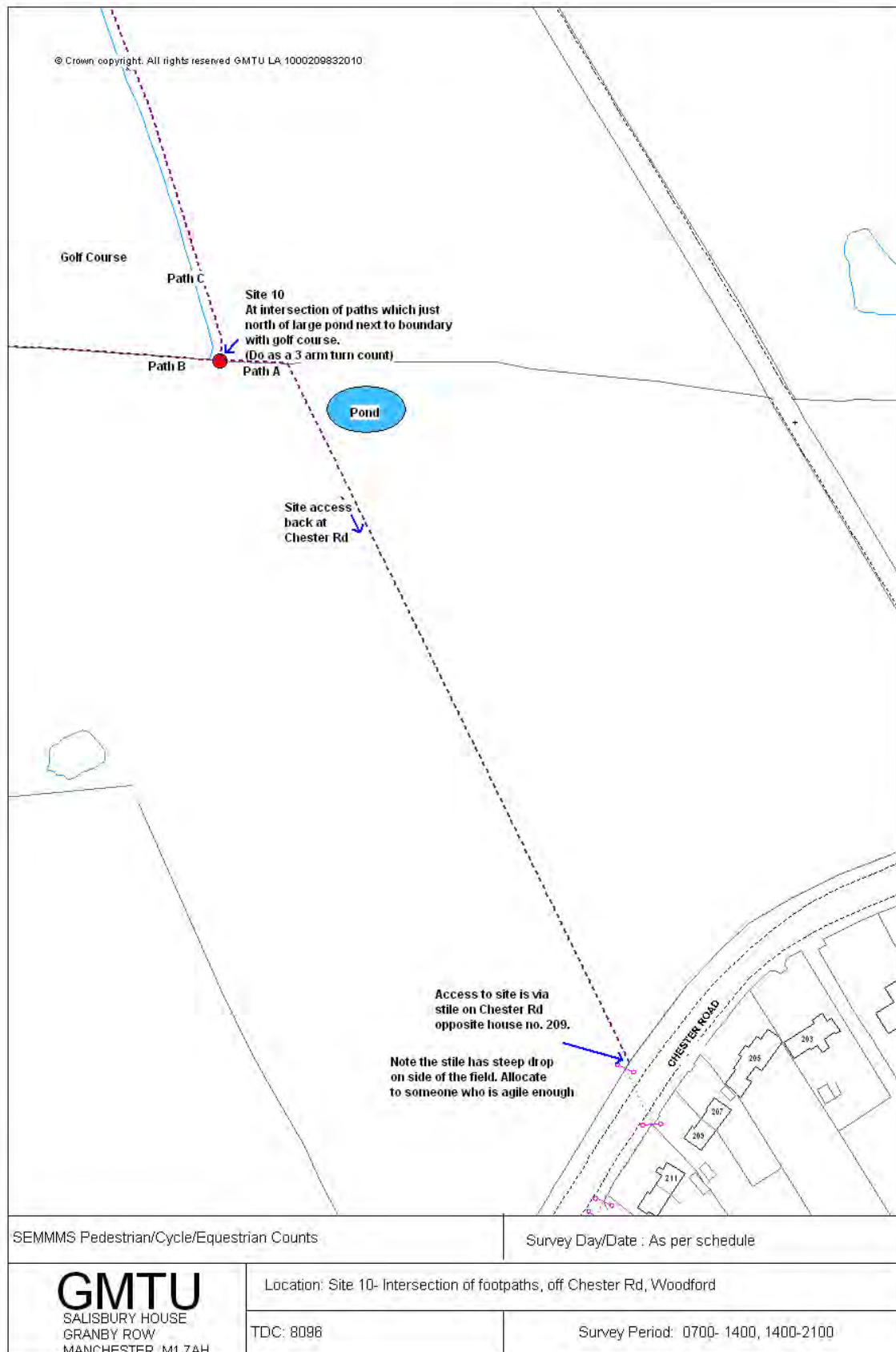

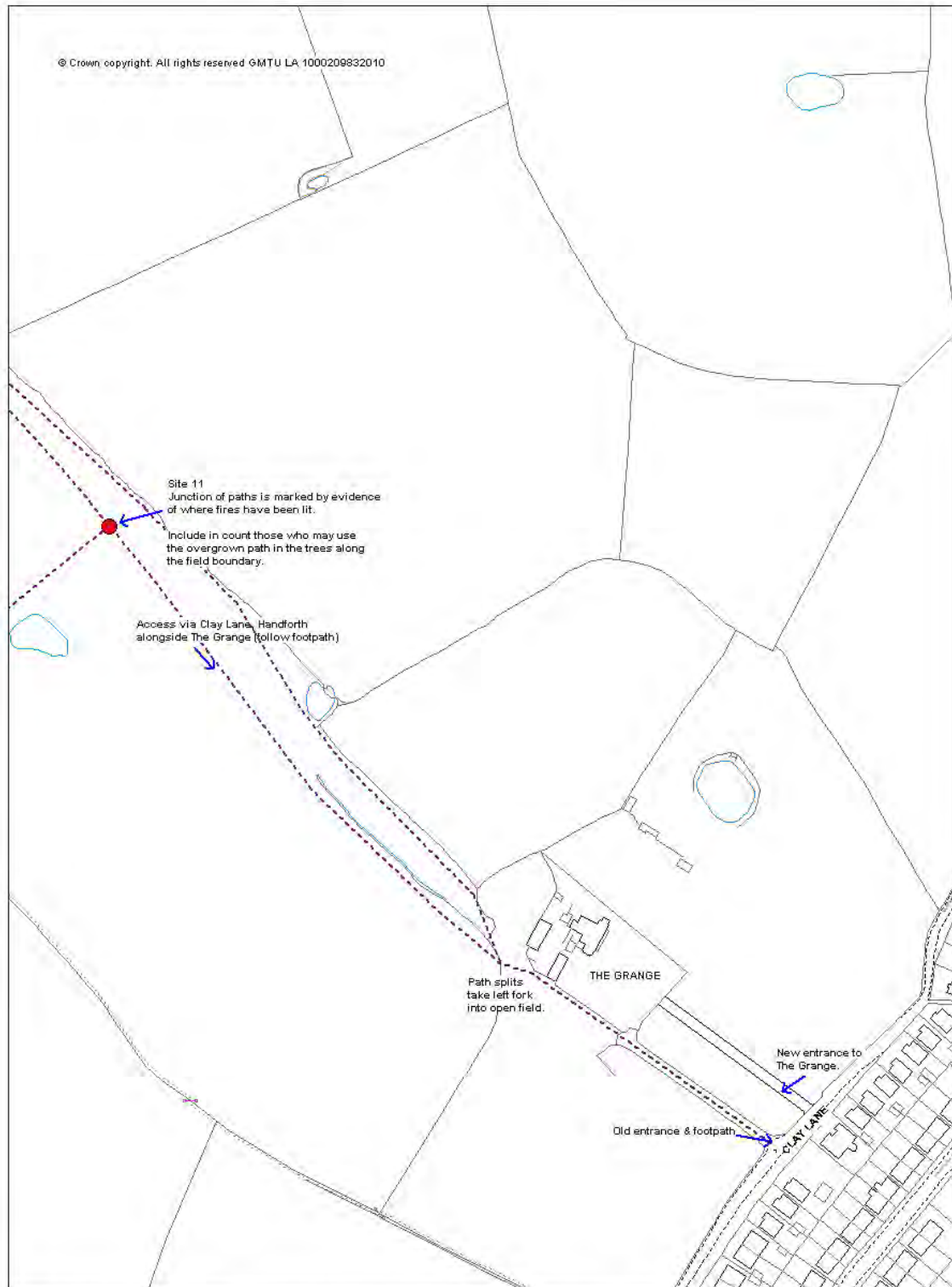

SEMMMS Pedestrian/Cycle/Equestrian Counts		Survey Day/Date : As per schedule	
GMTU SALISBURY HOUSE GRANBY ROW MANCHESTER M1 7AH	Location: Site 11- Intersection of footpaths, off Clay Lane Handforth		
	TDC: 8096	Survey Period: 0700- 1400, 1400-2100	

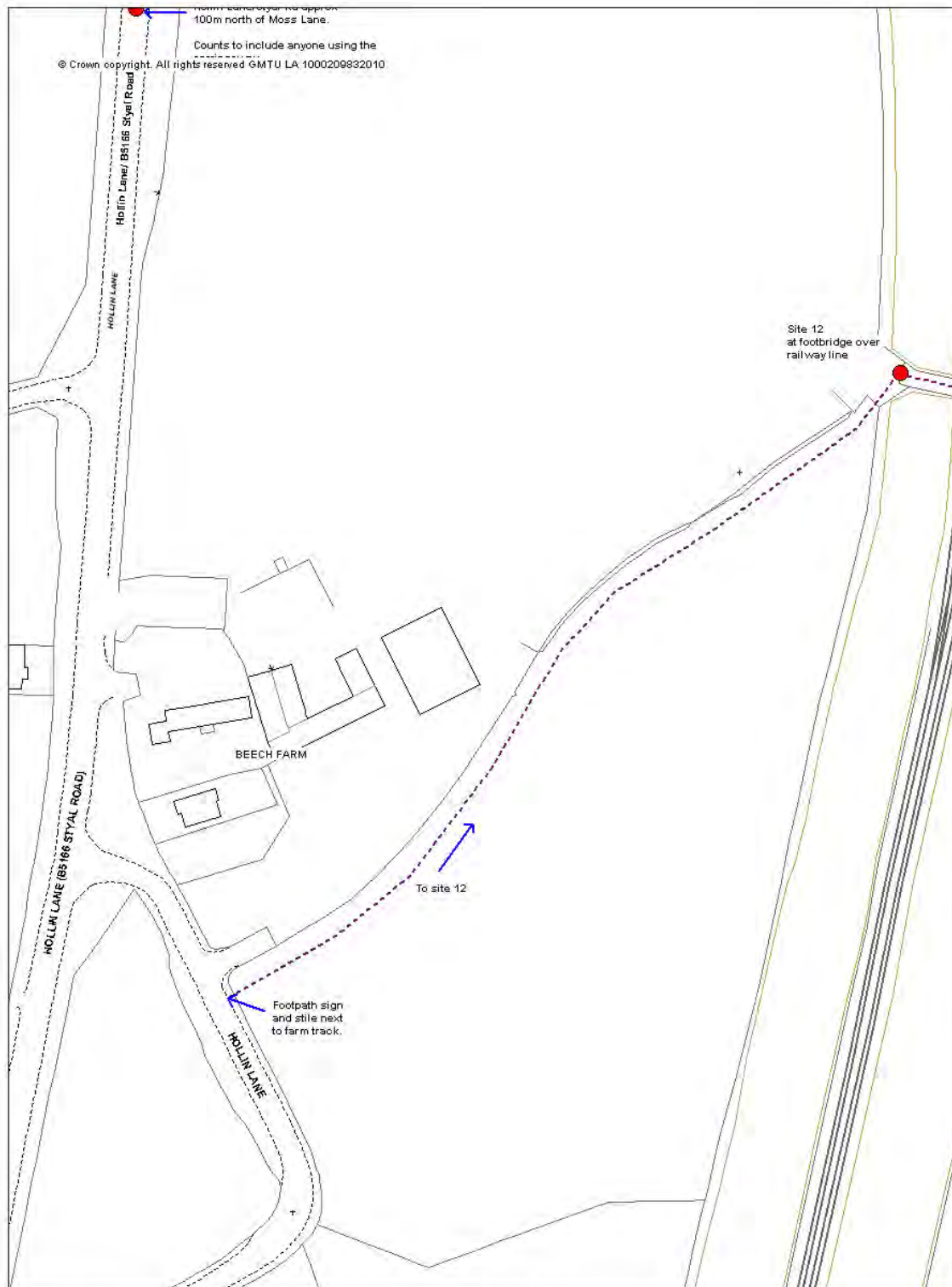

SEMMMS Pedestrian/Cycle/Equestrian Counts		Survey Day/Date : As per schedule	
GMTU SALISBURY HOUSE GRANBY ROW MANCHESTER M1 7AH	Location: Site 12- Footbridge over railway, nr Hollin Lane, Styal		
	TDC: 8096	Survey Period: 0700- 1400, 1400-2100	

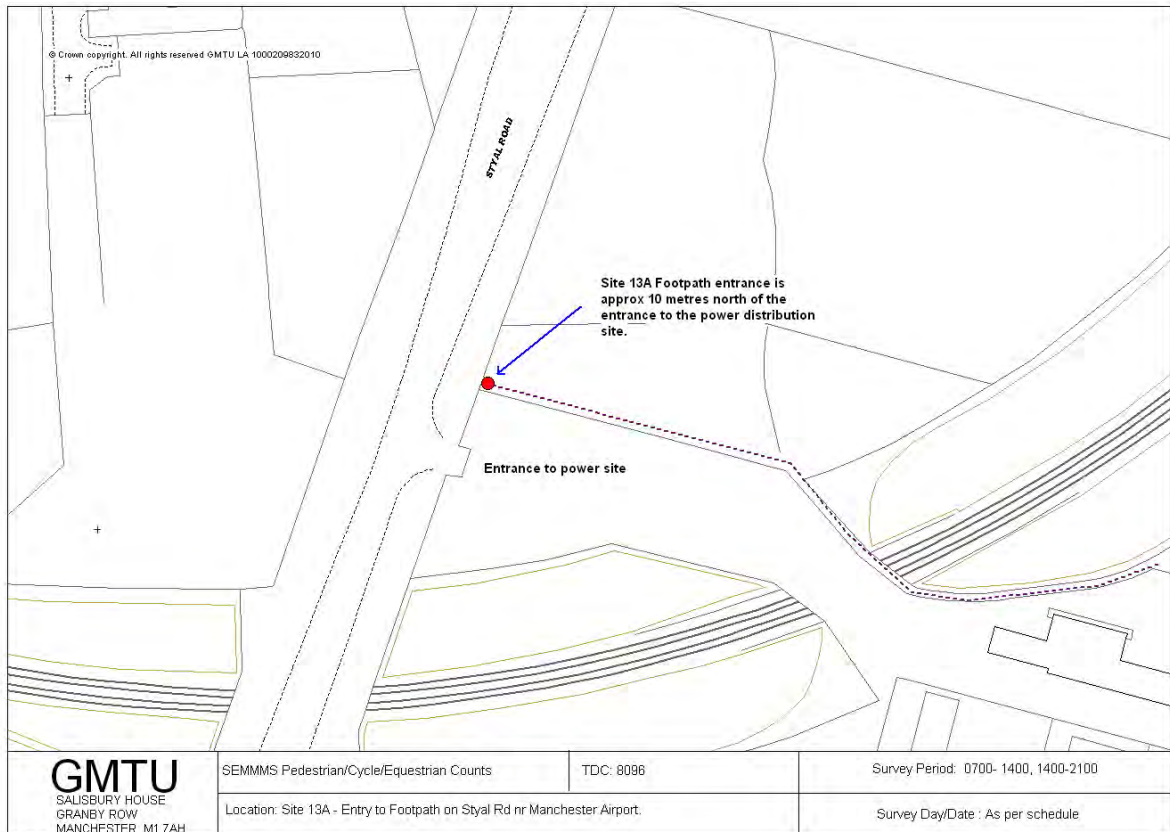

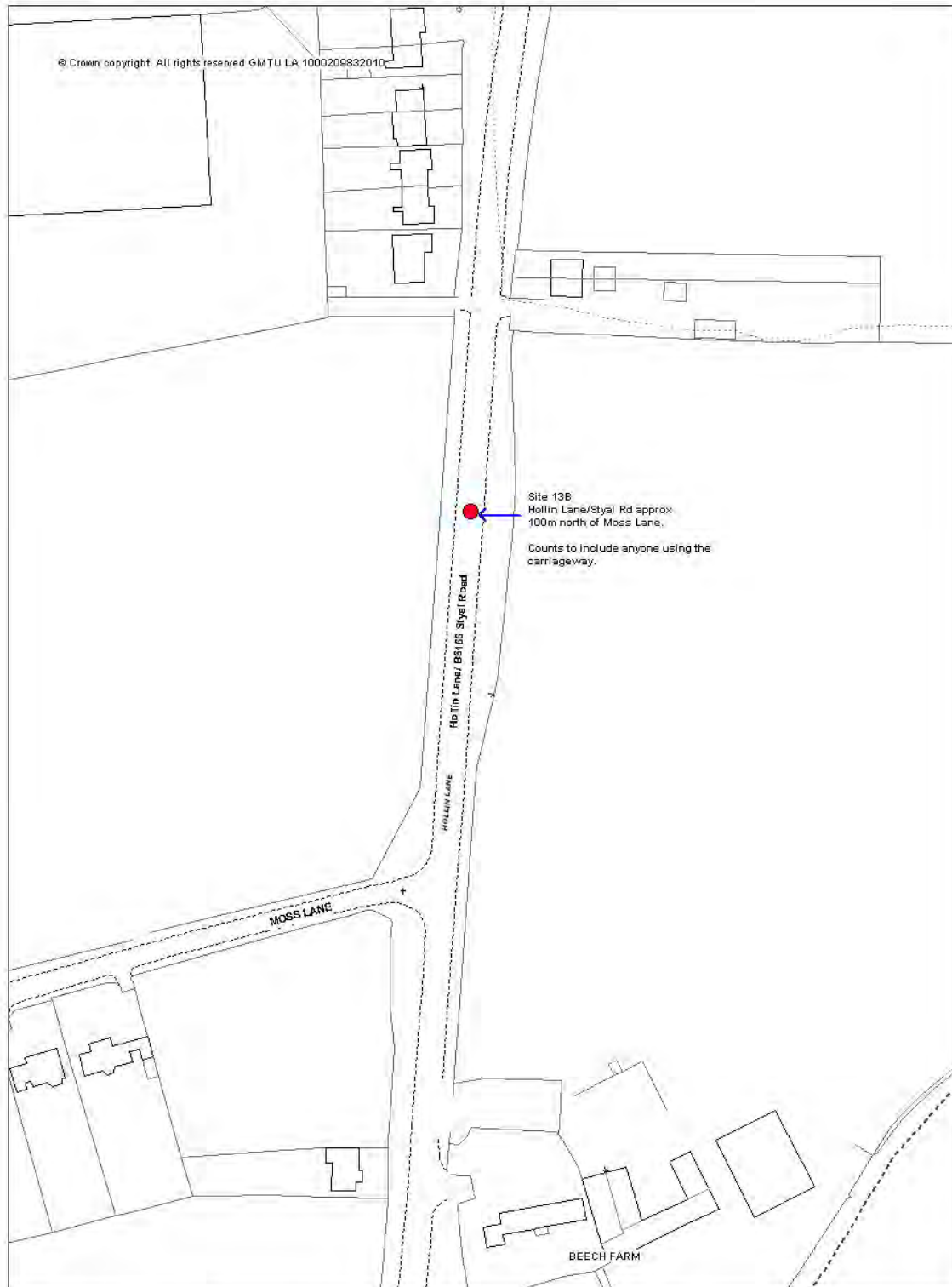

SEMMMS Pedestrian/Cycle/Equestrian Counts		Survey Day/Date : As per schedule	
GMTU SALISBURY HOUSE GRANBY ROW MANCHESTER M1 7AH	Location: Site 13B- Hollin Ln/Styal Rd, north of Moss Lane,		
	TDC: 8096	Survey Period: 0700- 1400, 1400-2100	

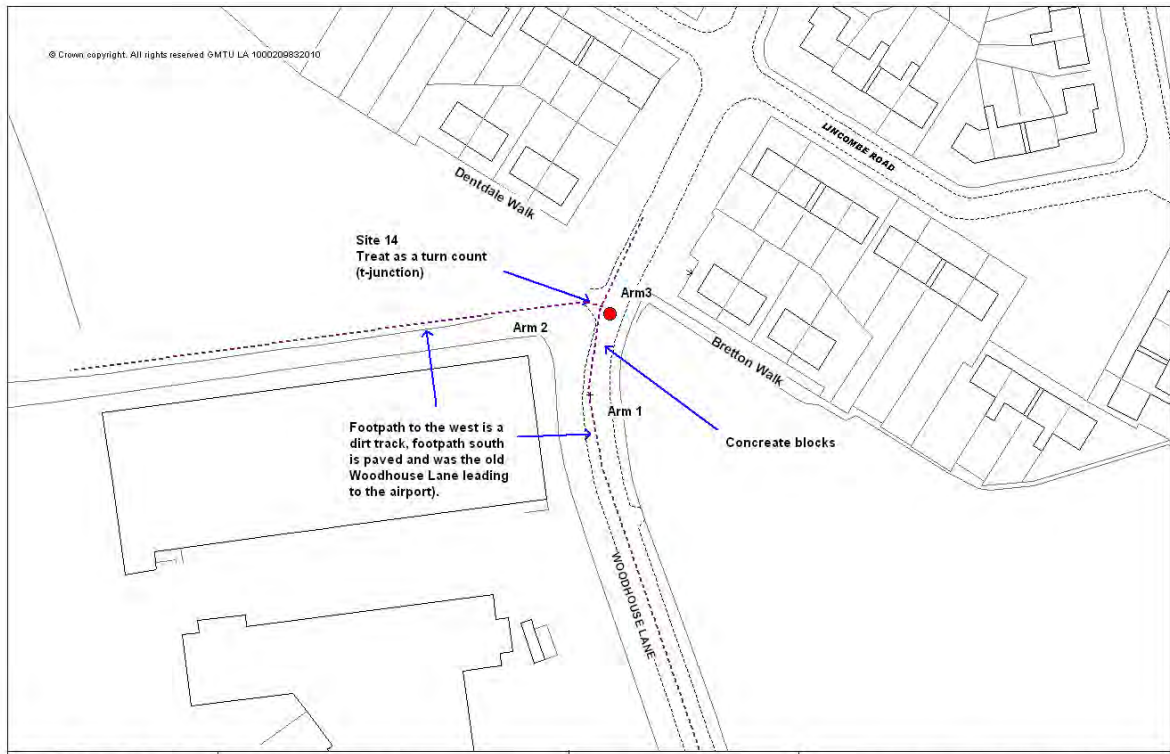

GMTU SALISBURY HOUSE GRANBY ROW MANCHESTER M1 7AH	SEMMS Pedestrian/Cycle/Equestrian Counts	TDC: 8096	Survey Period: 0700- 1400, 1400-2100
	Location: Site 14 - Woodhouse Lane, south of Dentdale Walk, nr Manchester Airport		Survey Day/Date : As per schedule

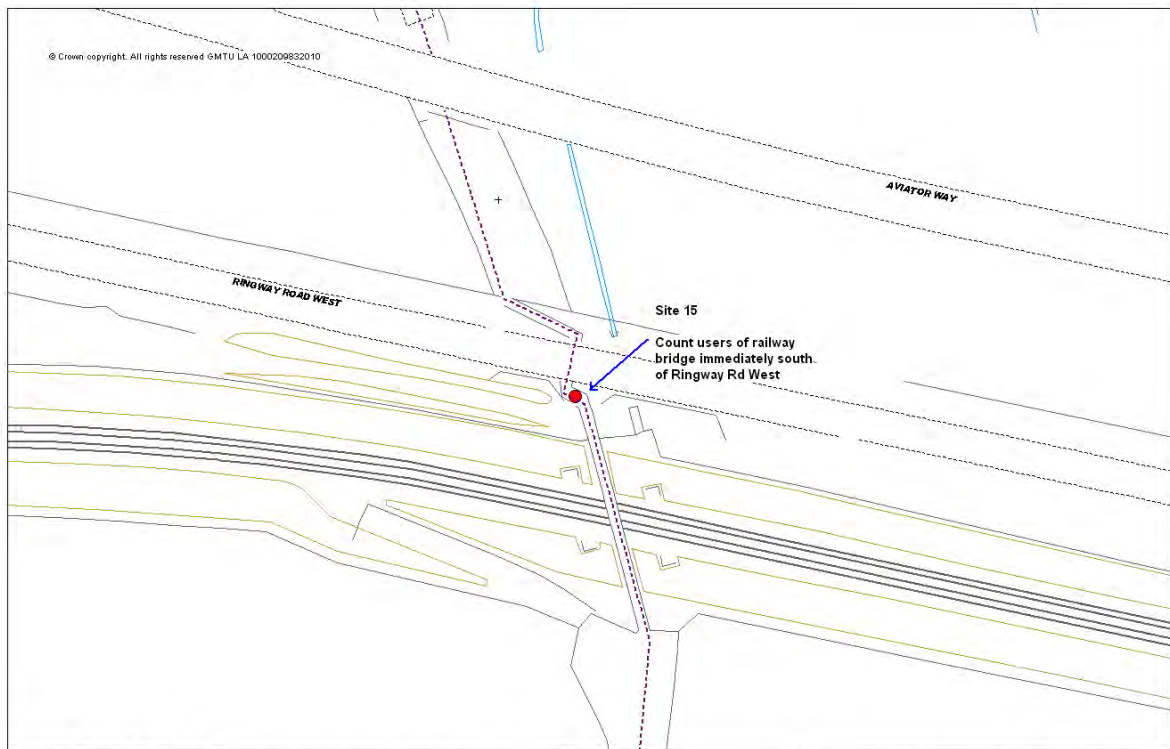

GMTU SALISBURY HOUSE GRANBY ROW MANCHESTER M1 7AH	SEMMS Pedestrian/Cycle/Equestrian Counts	TDC: 8096	Survey Period: 0700- 1400, 1400-2100
	Location: Site 15 - Railway Bridge south of Ringway Rd West nr Manchester Airport.		Survey Day/Date : As per schedule

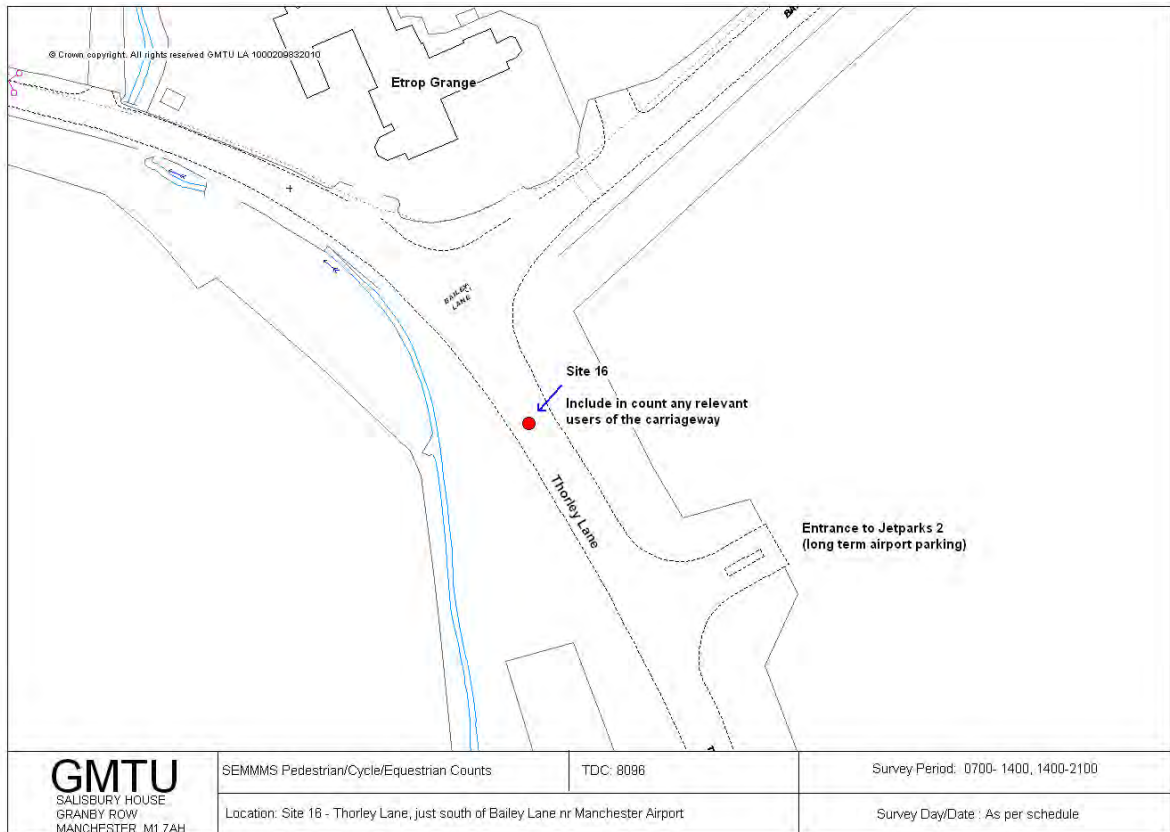

Appendix 2 – Interview Data Tables

Missed Interviews

Site	Not Missed	Missed	Total
1	77	20	97
2	48	15	63
3	94	34	128
4	337	46	383
5	23	4	27
7	7		7
8	15	3	18
9	3		3
10	30	1	31
11	49	3	52
12	13		13
13A	8		8
13B	222	84	306
14	191	52	243
15	102	11	113
16	387	143	530
Total	1606	416	2022
%	79%	21%	100%

Refused Interviews

Site	Not Refused	Refused	Total
1	79	18	97
2	57	6	63
3	110	18	128
4	330	53	383
5	20	7	27
7	7		7
8	18		18
9	3		3
10	28	3	31
11	48	4	52
12	9	4	13
13A	8		8
13B	229	77	306
14	199	44	243
15	80	33	113
16	467	63	530
Total	1692	330	2022
%	84%	16%	100%

No. of Interviews Conducted with Individuals and Groups

Site	Individual	Group	Total
1	64	33	97
2	56	7	63
3	83	45	128
4	298	85	383
5	19	8	27
7	7	0	7
8	16	2	18
9	3	0	3
10	24	7	31
11	41	11	52
12	10	3	13
13A	5	3	8
13B	232	74	306
14	192	51	243
15	98	15	113
16	400	130	530
Total	1548	474	2022

No. of Interviews Conducted by Period

Site	Early	Daytime	Evening	Total
1	9	69	19	97
2	13	37	13	63
3	16	72	40	128
4	67	241	75	383
5	4	17	6	27
7	2	2	3	7
8	0	10	8	18
9	0	3	0	3
10	10	13	8	31
11	12	23	17	52
12	0	8	5	13
13A	0	8	0	8
13B	77	147	82	306
14	48	138	57	243
15	10	81	22	113
16	112	298	120	530
Total	380	1167	475	2022
%	19%	58%	23%	100%

Appendix C

COPECAT

Final Report

For:
**Stockport Metropolitan
Borough Council**



COPECAT Audit of A6 to Manchester Airport Relief Road Proposals



By: Transport Initiatives LLP

September 2013

*Registered Office: Office 4
145 Islingword Road
Brighton BN2 9SH
0845 345 7623
www.transport-initiatives.com*

*Registered in England and Wales Partnership number OC310831
VAT registration no. 855 4208 21*



Contact for this project:

Steve Essex

The Rest,
Brookbottom
New Mills
High Peak SK22 3AY
Tel: 0161 449 9001
Mob:(07725 466 836
Email: steve.essex@transport-initiatives.com

Transport Initiatives LLP

Registered Office: Office 4
145 Islingword Road
Brighton BN2 9SH
0845 345 7623

www.transport-initiatives.com
Registered in England and Wales
Partnership number OC310831
VAT registration no. 855 4208 21

Checking and sign off	
Job: Copecat Audit of A6 – Manchester Airport Relief Road Proposals	Client: Stockport MBC
Job number: CSNW40	Version number: 1.1
Issued by:	
Steve Essex for and on behalf of Transport Initiatives LLP	
Signed 	Date 26 September 2013
Checked by: Rob Marshall	
	Date 27 September 2013

Contents

Introduction	4
General Comments	4
Path width	4
Going Dutch	5
Access ramps	5
Pinch points and conflict at ends of crossings	6
Transitions between carriageway and cycle path	6
Scheme in detail	7
Buxton Road	7
Old Mill Lane	8
Macclesfield Road	8
Woodford Road Bridge	10
Oil Terminal Junction	11
Chester Road Link Junction	12
Oil Terminal to Woodford Road	14
Woodford Road junction	14
A34 area general	15
Stanley Green	16
A34	16
Wilmslow Road	17
Relief Road west of Wilmslow Road	17
Styal Road	18
West of Styal Road	19
Recommendations	20
Appendix - COPECAT Forms	24

Introduction

This is a COPECAT cycle audit of the A555 at design freeze seven. It is a “level 4” audit although it could become part of a “level 5” one if Stockport Council deems it appropriate. The audit is based on a set of plans supplied by Stockport MBC, a meeting to discuss the scheme with Jim McMahon, Martin Rigby and Naz Huda, all of Stockport MBC, subsequent discussions with Naz Huda and attendance at a user group consultation meeting on 18th September 2013. No site visits were made specifically as part of this audit but visits were made to each location as part of an audit undertaken in 2005 and parts of the scheme have been visited subsequently. The plans supplied by Stockport MBC are drawings numbered 1007_3D_DF7_A6-MA_GA_201 to 209.

General.

There are some general points that apply to the whole scheme.

Path width

The proposed design provides a 2.5m wide shared pedestrian and cycle route alongside the entire length of the A6 to Manchester Airport scheme east of Styal Road (with the exception of the existing length of A555). On new sections of road it will be separated from the carriageway by a 2.0m wide grass verge.

Local Transport Note 1/12 para 7.34 says that 3.0m is the preferred minimum for unsegregated shared use. However it goes on to say that narrower paths work satisfactorily. Guidance on acceptable flows quoted in the document give a range of 62 to 450 users per hour for a 2.5m path which is more than would be expected on the new road. More important for safety is the verge. LTN 1/12 recommends 1.5m for roads with a 40mph speed limit, the proposed 2.0m is wider than this. There would be space in the scheme for a 3.0m cycle / pedestrian path and a 1.5m verge. Given that use is expected to be relatively low, safety and amenity would be improved by keeping cyclists further from the carriageway even if the path they use is technically substandard.

West of Styal Road the proposal is for a 3.0m wide path immediately adjacent to the kerb edge. If the outside edge has a notional verge (recommended 1.5m, absolute minimum 0.5m) then an effective path width of 1.5 – 2.5m remains. Clearly this is of a lower standard than the rest of the scheme and it would be better if it could be wider. In the draft version of this audit it was suggested that the cycle / pedestrian path could leave the line of the road here and join the old line of Ringway Road so as to be better integrated with south Wythenshawe. The opinion of the scheme designers was that this would be in conflict with the airport navigational system and metrolink. In the absence of plans for either a definite conclusion cannot be made. It is recommended that Manchester City Council consider the option of moving the path further away from the line of the road.

While street furniture location is a final design issue, lighting columns, sign poles, control cabinets and other street furniture should be kept clear of the cycle / pedestrian path. The clearance for any item higher than 600mm (for example sign poles) should be 500mm from the path edge.

Going Dutch

There is currently considerable interest in Dutch designs in this country. Consequently many cyclists would like to see features such as segregated cycle tracks and subways to cross major roads. Many of these features are justified by high levels of cycle use in the Netherlands and although often assumed to be universal across the country, in practise are not found everywhere. The Dutch are usually much clearer in defining what is and is not a cycle route than we are and their designs usually make logical sense to the user. While there are not the flows, and in many cases the space, to provide the scheme to Dutch standards, if cyclists can clearly follow the Relief Road foot / cyclepath with confidence then part of the Dutch ethos will have found its way into the scheme. The lengths of cycle / pedestrian paths between junctions will be easy to follow; if cyclists get lost it will be at the junctions. At the final design stage care should be taken to ensure that the designs are coherent.

Access ramps

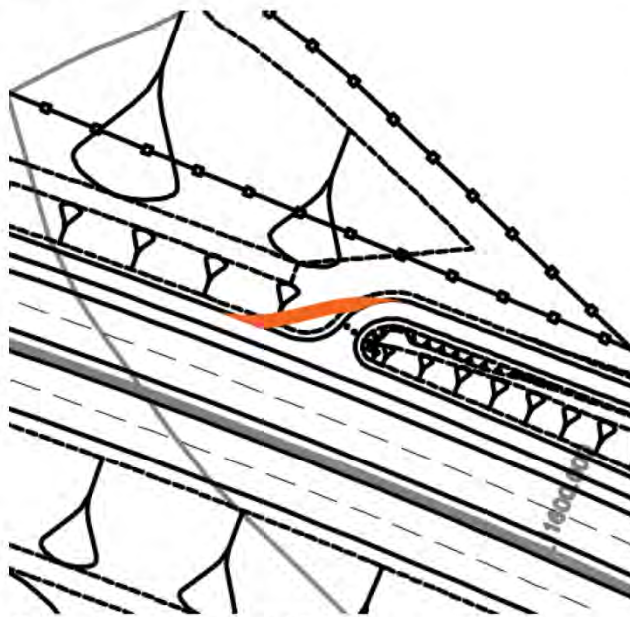

Diagram 1. Woodford Road

Cyclists prefer to make use of the speed they have gained going downhill rather than having to stop. The design of the road shows ramps leading down to the proposed cycletrack as turning sharply and meeting the cycle track almost at right angles. While this is a conventional highway design where motorists know they have to slow to give way, here cyclists will soon learn that the need to give way will be largely unnecessary and thus many will be tempted to use speed gained travelling down the ramp to help them along the cycle track. There is thus a possibility that they could overshoot the cycle path and verge to end up on the carriageway. It was originally recommended that the design should be altered to that shown in diagram 1.

However, in subsequent discussions, Stockport Council expressed some reservations about this. It is recommended that the Council reconsiders altering the alignment at these junctions. It is also recommended that the bollards shown on the plan are relocated to a straight section of path. The gap between the bollards should be 1.2m minimum and the line of bollards should extend beyond the width of the path as vehicles will be able to pass around them.

Reducing pinch points and conflict at the ends of crossings

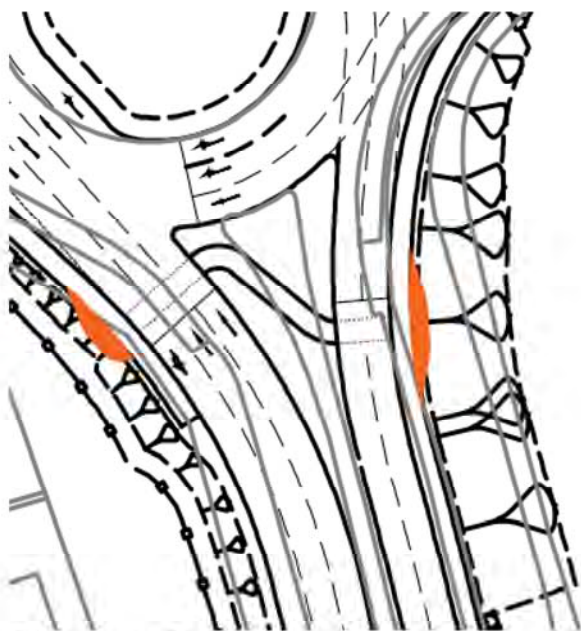

Diagram 2. Stanley Green

The drawings supplied show that the width of footways and cycletracks are the same at the ends of crossings as they are between them. Crossings can be conflict points as the signal poles use up some of the width and cyclists and pedestrians have to turn through 90 degrees to use the crossings. Often users travelling along the path will have to avoid those waiting thus, a wider path would be safer and more convenient to all users.

There are also some safety implications of having a tight turn onto the crossing. Where a cyclist (or pedestrian) is travelling in the same direction as general traffic before turning onto the crossing, a tight radius means they are less likely to be able to check whether traffic is actually stopping before they start to cross.

The minimum curve radii in DMRB should also apply to these situations.

It is therefore recommended that, where possible, paths should be locally widened. Where they are in cuttings or on embankments this may require a short length of retaining wall. Consideration should be given to using cranked rather than straight poles to gain additional room.

Transitions between cycletrack and carriageway

The points where the cycle route leaves or joins the carriageway should be designed so that it is clear where cyclists are going and cyclists can make the transition without losing more speed than is necessary. Where cyclists join the cycle path at right angles, particularly from a signalled crossing, there should be little need to hurry as they are protected by the signals. However, where cyclists join and leave the cycle / pedestrian path at a shallow angle away from a junction, conditions are different. Of particular concern are places such as Stanley Road where cyclists approaching the scheme on the carriageway transfer to the cycle and pedestrian path. At these points motorists are less likely to expect the cyclist they are following to slow down and so when leaving the carriageway it is safer if cyclists can reduce speed on the cycle track rather than on the carriageway. Clearly there is a trade-off between slowing on the carriageway with the danger of being hit from the rear by a vehicle and speeding on the foot/cycletrack with the danger of hitting a pedestrian. It is possible to design some form of transition but this will require additional footway width.

Where cyclists rejoin the carriageway they should do so onto a protected cycle 'slip' lane which should continue for at least 25m before terminating. There is an example of this good practice on Dan Bank in Marple.

It is recommended that the Council pay particular attention to the ability of cyclists to leave and join the carriageway safely, conveniently and comfortably at the ends of the scheme.

The scheme in detail

Plan 201

Western junction with Buxton Road.

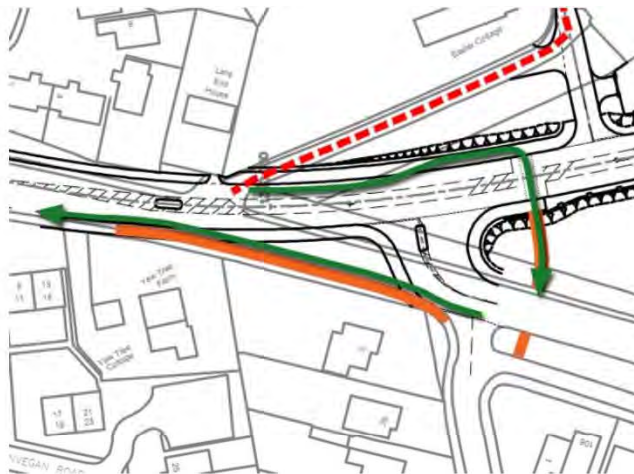

Diagram 3. Buxton Road West
Cyclists' routes shown in green
New path in orange

Some cyclists may prefer to use the new length of the A6, particularly in the eastbound direction. However most cyclists travelling east are likely to prefer to use the old line of the A6 or will be travelling to somewhere served by it. These cyclists will need to turn right at this junction. There is a crossing marked to the east of the junction. It is recommended that this is used as a toucan crossing to assist cyclists making the right turn. On the south east side of the junction there is no need for the footway to hug the kerb line. It could run straight across the grass area (subject to levels) thus giving cyclists and pedestrians a more direct, shorter route.

Failure to provide for 'desire lines' usually results in informal, worn, muddy paths developing as path users make up for the design deficiencies of the original layout. Westbound cyclists could be allowed to join the new line in a protected cycle lane which could run to a point just west of the road serving the police station. The footway does not need to hug the kerblines.

Buxton Road Junction east.

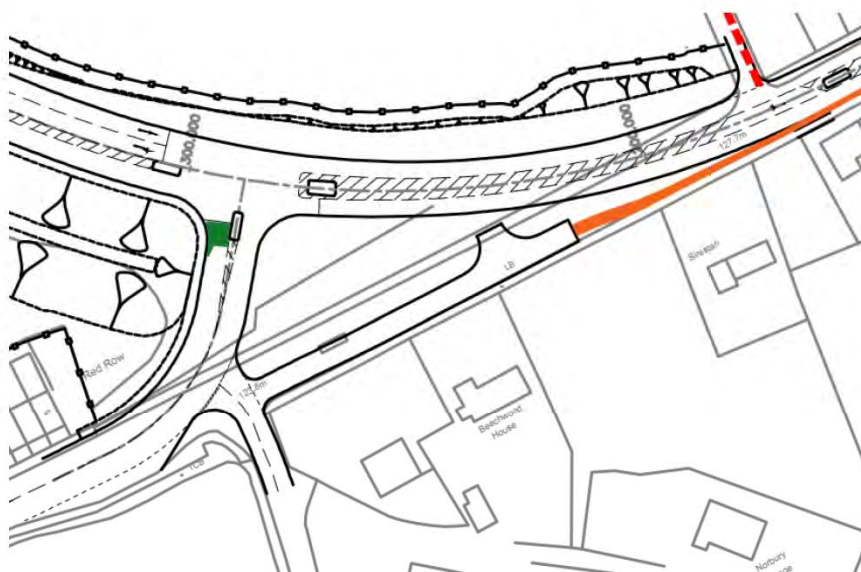

Diagram 4.
Buxton Road East

ASL shown in green,
additional foot/cycle
way in orange

There are two ways cyclists might want to continue east up the A6. The first is on carriageway. It is recommended that an advanced stop line (ASL) is installed at this junction to make this turn easier. In 2005 Transport Initiatives investigated possible improvements for cycling along the A6 between Mill Lane and the Middlewood Way. One option considered

was to convert the southside footway to joint pedestrian and cycle use. This would be a preferred way for some cyclists (particularly less confident ones) to continue east towards the Middlewood Way. This idea was not recommended at the time due to the narrowness of the footway in the vicinity of Middlewood Road. The SEMMMS proposals enable this issue to be overcome as cyclists can use the new cul de sac alongside the 'problem' footway. It is recommended that the footway is converted to joint pedestrian and cycle use from the end of this cul de sac to the Middlewood Way. Parts of the footway will require widening. Flush kerb detailing at the transition point and measures to stop inconsiderate parking should also be included in any final design.

The flow along Middlewood Road is likely to be higher than that along Buxton Road which it joins and so motorists turning out may not pay sufficient attention to cyclists proceeding along Buxton Road. It is recommended that a length of green coloured advisory cycle lane is laid across the mouth of the junction to highlight the presence of cyclists.

Plan 202

Old Mill Lane access.

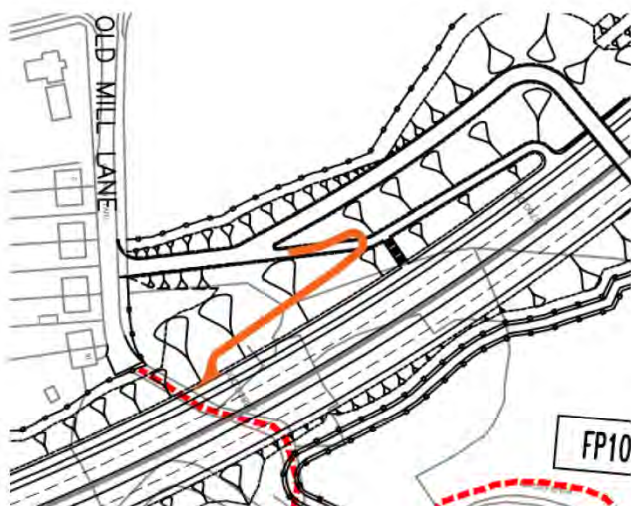

Diagram 5. Old Mill Lane

The ramp from Old Mill Lane to the A555 runs to the east. There is no benefit in cyclists using the Relief Road cycletrack to travel between Old Mill Lane and the eastern end of the scheme as remaining on the old road network is shorter and involves fewer gradients. While it is understood that the ramp's direction is dependant on more factors than just cycling, running the ramp in the other direction would shorten cycle journeys and add considerable convenience. It is therefore recommended that the Council review the direction of this ramp.

It is also appreciated that the most the ramp could run to the west is shown on the diagram left.

Macclesfield Road.

The Relief Road / Macclesfield Road junction provides for east west cycle movements on the cycle / pedestrian path, via four toucan crossings between various islands. North south movements are provided for on the carriageway. No specific provision is made for cyclists wishing to turn between the east west off highway route and the north south on carriageway one.

Of initial concern is the number of steps that the relief road cycle route uses to cross the junction in the preliminary design. This comment makes assumptions about the signal staging, but in similar junctions of this nature it is usually possible to reduce the number of steps cyclists take in crossing the junction. This will increase the convenience for cyclists and also reduce the incidence of non compliance with the signals. Logically, if it is assumed

that cyclists can cross the junction in the north south direction in one step then they should be able to make the broadly similar east west crossing in fewer than four steps, as proposed. At the Princess Road/Greenheys Lane junction in Hulme, Manchester, cyclists are able to



cross the junction in two steps. It is anticipated that with the signal stage shown in diagram 6, cyclists would have sufficient time to make the manoeuvre shown in green. It is thus recommended that the north side of the Macclesfield Road junction should be redesigned so that the cycletrack along the line of the road crosses the junction in fewer steps.

Diagram 6. One signal stage at Macclesfield Road

There is no need for the advanced stop lines for north and southbound cyclists as there will be no need for them to make right turns, nor will there be left turning vehicles crossing their path after the stop line. It is recommended that these be removed from the proposals

Both north and southbound cyclists cross the paths of vehicles turning left onto the new road. Judging by the long left turn lane it is expected that the northbound left turning flow will be substantial. Cyclists are likely to feel intimidated cycling on the long cycle lane between the left turning and straight ahead traffic. These long central lanes have also been associated with injury accidents to cyclists. It is recommended that the central cycle lane be abandoned and instead use a widened footway on the west side of the road, cross the left

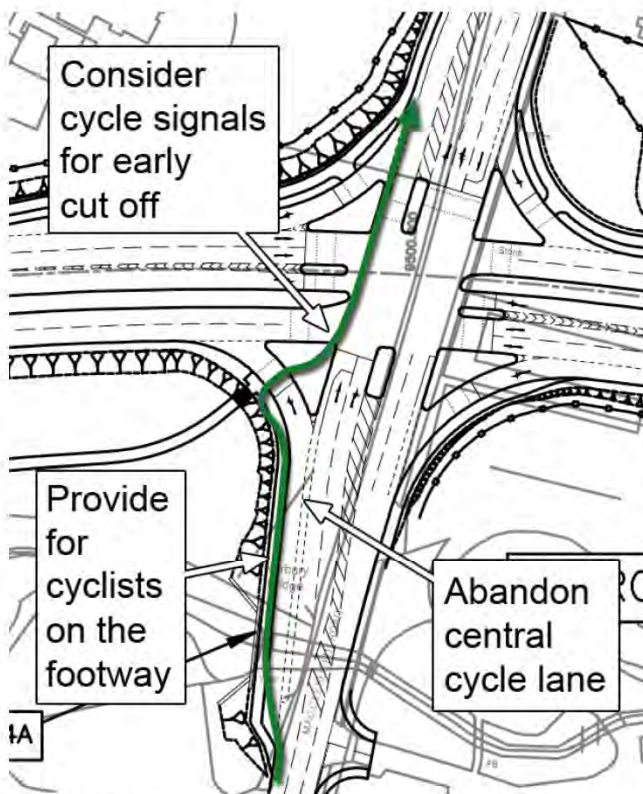

Diagram 7
Macclesfield Road – Northbound Cyclists

turning traffic using a cycle/pedestrian crossing where the proposed pedestrian crossing is and then be returned to the carriageway to cross the remainder of the junction as designed. A cycle lane could be marked across the junction in both directions to guide cyclists. A slow cyclist could take a long time to clear the junction. The designers should consider a separate stop line after the jug handle crossing of the left turn flow which could be returned to red before the signals for the main northbound general traffic flow. An example of a jug handle crossing of a left turn slip using common straight ahead signals is on the westbound side of Ashton Old Road, Manchester, at its junction with the Mancunian Way. An example of a separately signalled jug handle is the northbound side of the A538 at junction 6 of the M56 west of Manchester Airport.

One issue that the current design fails to address adequately is that of cyclists on the east west cycle pedestrian path turning onto Macclesfield Road and vice versa. Coherent, convenient and legible facilities to enable cyclists to make these turns safely will need to be solved before the final design stage is completed. If this is not done, cyclists encountering the junction will need to devise their own, possibly dangerous ways to overcome the design shortcomings. It is recommended that the Council consider how these turns can be facilitated.

Plan 204.

Woodford Road Bridge.

This bridge is shown as having a wider footway on the north western side. It is understood that this is the result of a suggestion by users and is to provide a link across the road to a proposed bridleway on the south west side.

Guidance recommends that there should be a verge or other margin between the shared use path and the carriageway of at least 0.5m. A verge would be impractical on a bridge and so it is recommended that the first 0.5m is made from a contrasting material. The remaining width is 2.5m, the same as along the main scheme, although the presence of the parapet for the bridge means the "effective width" (LTN 1/12) is 2.0m. This width should be adequate for the expected use.

It is important that users can safely access the widened footway. Due to its short length it is unlikely to give benefit to cyclists travelling along Woodford Road. Thus we need to consider

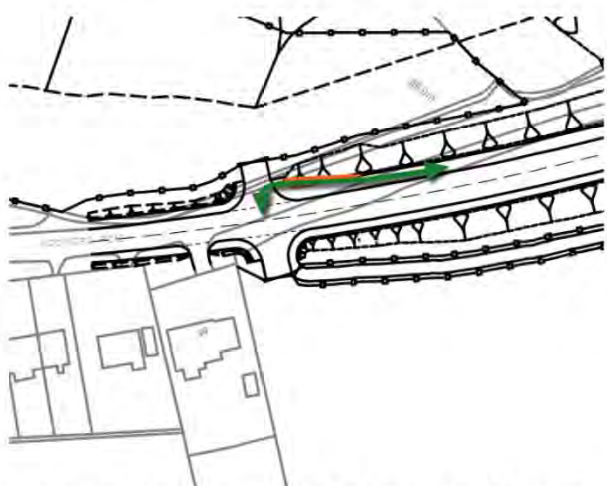

Diagram 8. Western end of Woodford Road bridge. New foot/cycleway shown in orange, cyclists and equestrian route in green.

cyclists and pedestrians (and maybe equestrians) turning onto the path from Woodford Road or crossing to the bridleway. A dropped kerb should be provided at the top of the ramp to the Relief Road path for cyclists wishing to travel to or from the north east. At the south western end of the bridge it is recommended that the foot/cycleway be realigned to make it easier for cyclists and horse riders to position themselves at 90 degrees to Woodford in order to cross. Effectively this allows them to make a larger radius turn. The Council also need to consider the gradient of the field access that cyclists and equestrians will be using.

The plan shows bollards at the ends of the access ramp. Presumably these are to prevent unauthorised use by motor vehicles. The clear space between the bollards should be 1.2m minimum. They should preferably be located on a straight section of the ramp and the line of bollards should be extended across any drivable verge.

The bottom end of the ramp is a location for the general suggestion that the design should allow east bound cyclists to join the ramp without losing speed and similarly that westbound cyclists using the ramp should be able to avoid braking more than necessary.

Plan 205

Oil Terminal Junction.

The design of this section includes a large number of chicanes, but not at all approaches to the pegasus crossing points. The Council needs to review this inconsistency. The staggered barriers forming the chicanes should be arranged so that the user crossing the road faces towards the oncoming traffic. While the chicane at the bottom of diagram 9 is correct the associated chicane on the eastbound carriageway is the wrong way round. The chicane at the exit of the Oil Terminal road is the correct way around but is poorly aligned with the crossing and so users face away from oncoming vehicles. The drawing supplied does not show guard railing. This would need to be installed or else users would make their own shorter routes to the crossings avoiding the chicanes. It is recommended that the Council consider the need for guardrailing to enforce use of the chicanes or review the need for the chicanes themselves.

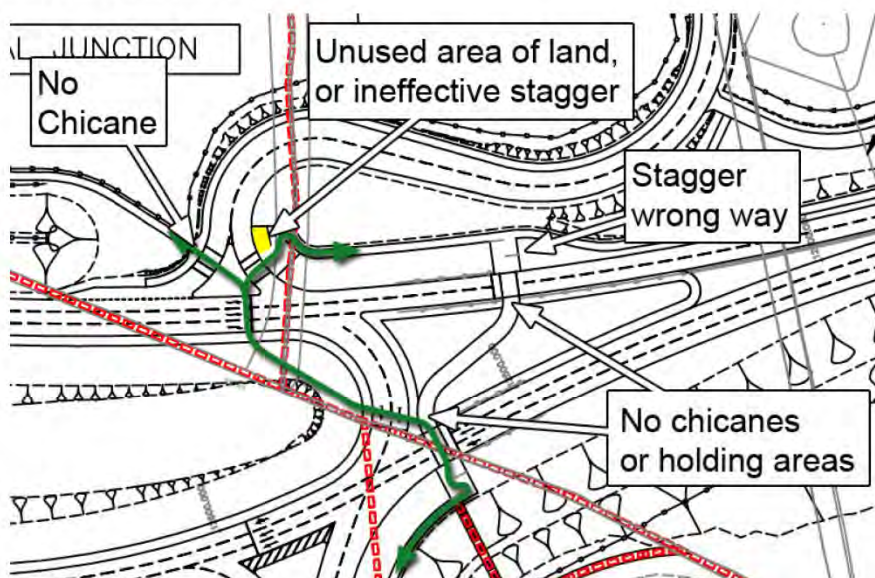

Diagram 9
Oil Terminal Junction
Chicanes

Setting the path away from the road makes a more pleasant experience for users as well as ensuring horses are less likely to be 'spooked'.

There is concern about the crossing of the eastbound carriageway that is set away from the junction. This crossing is likely to be lightly used. Regular users of the Relief Road who would normally see the traffic lights on green are less likely to react when they see them on red. A path taking the route as shown left may be quicker to use than one via the offset crossing but the need for storage for horses needs to be set against loss of storage space for vehicles making the west to south turn towards Chester Road.

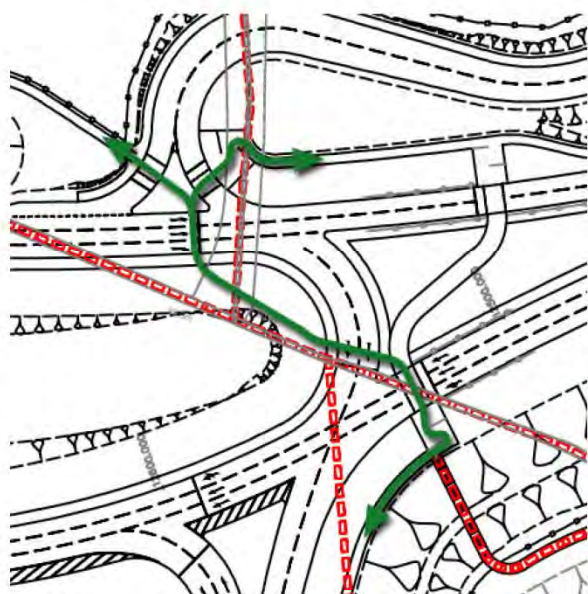

Diagram 10
Oil Terminal Junction
Alternative route

However, having said the above, it may well be that the oil terminal will be relatively lightly used and thus the comments made regarding the safety of the offset crossing would also apply to the eastbound stopline within the junction. The Council should consider the safety implications of having an additional stopline set away from the Oil Terminal junction.

Chester Road Link Junction

The cycle facilities at this junction consist of a shared pedestrian / cycle /equestrian route from the Oil Terminal junction with pegasus crossings to reach the old line of Chester Road and a shared footway on the northbound approach leading to a toucan crossing to the southern triangular island. In discussions with the Council it appears that westbound cyclists are expected to use the existing line of the road. While the westbound route is easy, provided that there is a gap in the footway to allow them to rejoin Chester Road west of the junction, the eastbound route is more difficult.

Two suggested design details are: firstly, that the turn from the foot/cyclepath on the northbound approach onto the toucan would be easier if the path was widened at the end of the crossing; and, secondly, there needs to be a point where cyclists are returned to the carriageway preferably by means of a protected cycle 'slip' and a short length of marked, on carriageway, cycle lane.

Of more concern is the number of steps that cyclists need to make to complete the right turn. There are various ways in which this junction could be signalled with different effects on the time taken for cyclists to get through it and some require more than one signal cycle. It would be expected that cyclists would treat the toucan and pegasus signals as "give ways" to reduce their delay and normally this does not give rise to accidents. However, designers should be wary of the turn shown in red in diagram11, particularly if the signal regime chosen includes a stage where the north to east turn is running but not the south to east. In such a situation regular users would not expect to have to give way to any vehicle and so a bicycle, often not usually looked for by drivers, could easily be missed.

To enable cyclists to make the right turn in one step would require a redesign of the junction. It is recommended that the Council reconsider the south west to east cycle right turn at the junction.

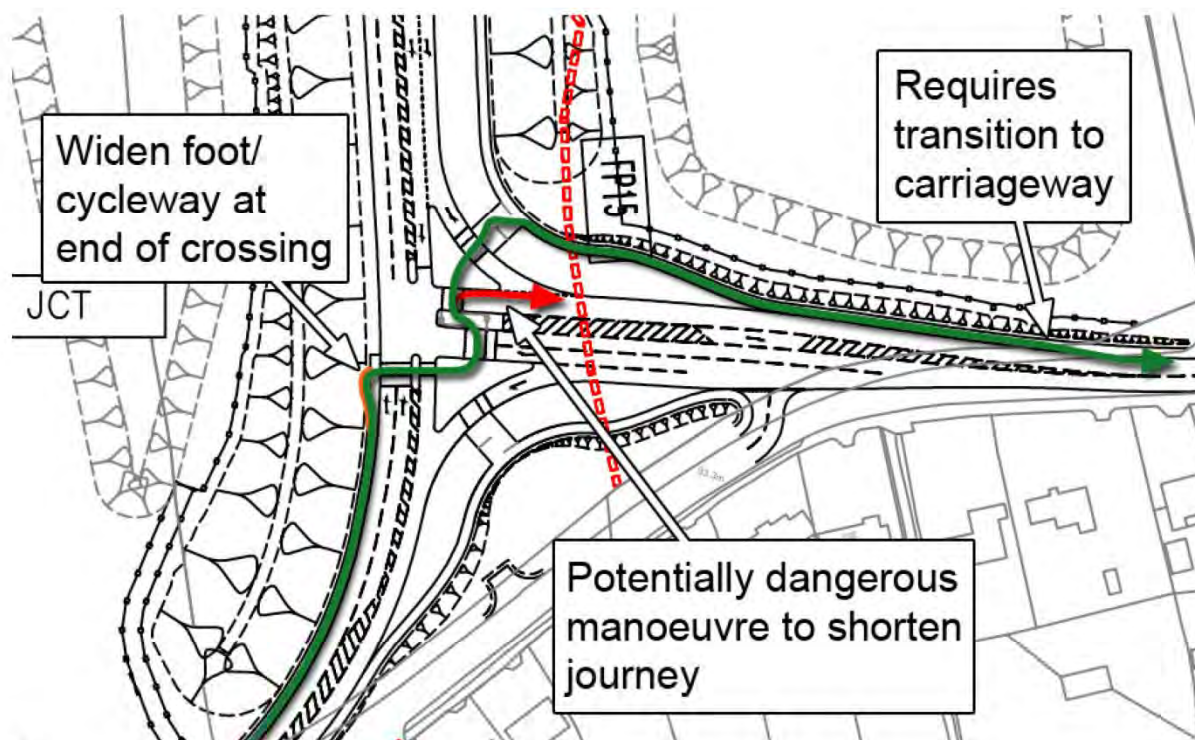

Diagram 11. Chester Road junction – right turn issues

Cyclists travelling south west to east on the carriageway could be assisted by an advanced stop line at the signals.

To enable westbound cyclists to rejoin Chester Road a gap in the footway would be required. There is however, space to construct a short length of cycle path ending in a cycle lane thus making it easier to rejoin the road without having to slow down more than necessary. The cycle lane would have to end at the point where the new alignment meets the old.

Some eastbound cyclists may prefer to avoid the junction altogether by following the line of the old road. In any case provision should be made for eastbound cyclists to use the old road as they may wish to visit a property on it. To assist eastbound cyclists to join the old section of road there should be a right turn lane in the area occupied by hatching, and further protected by an island. There will need to be a gap in the footway, this could be the same as the one used by westbound cyclists.

To rejoin Chester Road eastbound cyclists would have to cross 4½ traffic lanes. It would be safer to turn right in two stages where the road is narrower. It is therefore recommended that an additional island is constructed in the hatched area to the east of the proposed junction. The island should preferably be 2.5m wide. The exact position of the island will need to be determined at the final design stage; the further east it is, the easier the road will be to cross but the hatched area will be narrower. The link to this island should be constructed so that westbound cyclists can access and use it easily.

It is recommended that the Council improve the links between the old and new alignments.

There will need to be a link to the Pegasus crossing from the old line of road to enable cyclists to reach the link to the Relief Road.

There may need to be extensive guardrailing to prevent users avoiding the chicanes on the approaches to the Pegasus crossings.

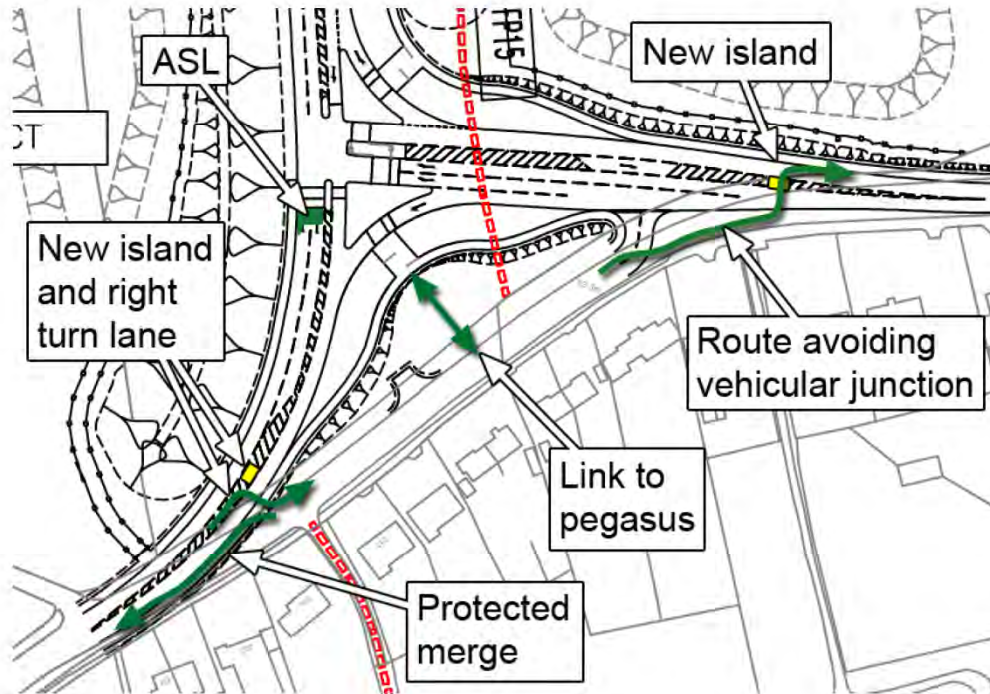

Diagram 12

Chester Road Junction. Alterations for cyclists using the current line of road

Path to Woodford Road junction from Oil Terminal Junction

This length of path will be a more attractive section to use as it is separated from the A555 by the embankment and at the top of the cutting. The Council will need to ensure that the forward visibility at the kink approaching the Woodford Road junction is adequate. The link to Albany Road is commended.

Woodford Road Junction

The Woodford Road junction is very tight with very little space for cyclists. The main issues for east west cyclists on the A555 route revolve around the crossing over Woodford Road. These are:

- a pinch point at the northern corner of the triangular island as the western half of the crossing is located very close to it
- a pinch point in the 'sheep pen' on the central island
- the tight dimensions of the cul de sac eastern arm of the junction means that there could easily be conflicting movements.

The path from the Oil Terminal junction runs parallel to the A555 whereas users are likely to want to take the natural direct line and cut the corner to get to the crossing.

It is recommended that the Council investigates the possibility of making the crossing over Woodford Road a one stage crossing rather than a two stage one. It could still run via an island upon which users could wait but cyclists could cross Woodford Road in one go. This would enable the western half of the crossing to be moved away from the corner of the triangular island.

East of the crossing, cyclists should use the carriageway of the cul de sac. They will need guiding both from the crossing and from the Oil Terminal direction, perhaps by short lengths of segregated path.

The path towards the Oil Terminal junction should be realigned to provide a shorter route.

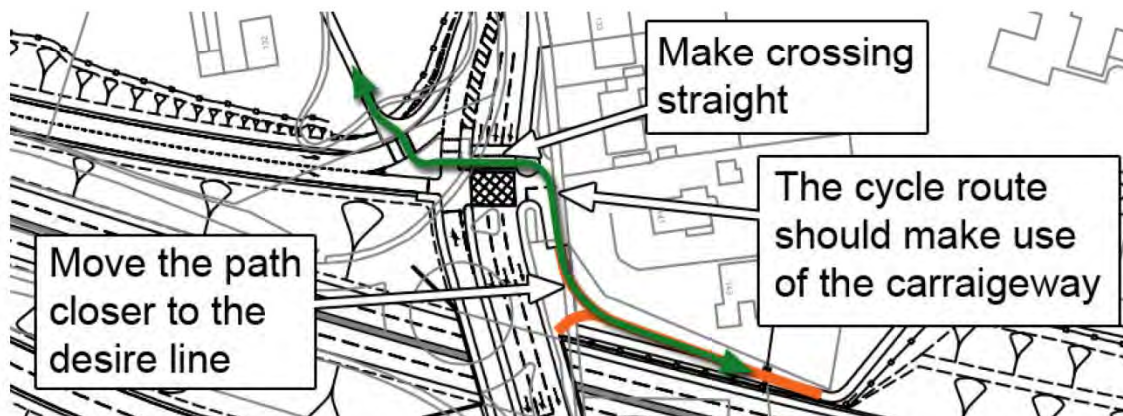

Diagram 13 Woodford Road junction

The main issues for cyclists travelling along Woodford Road are the restricted width and the northbound left turn flow onto the A555. Currently there is no simple, deliverable option to improve matters unless more space becomes available. If there is more carriageway space the Council is advised to provide for northbound cyclists on the carriageway and to consider either a short central cycle lane or 'jug handle' facilities to enable cyclists to avoid left turning traffic. It must be noted that replacing the existing roundabout with signals will be safer for northbound cyclists even in the absence of any additional facilities.

Plan 207

General

Cycle facilities are provided at both the A34/Stanley Road and A34/A555 junctions with a cycle track linking the two. The linking cycletrack does not form part of any longer route such as something along the A34 and exists solely to link the two roads. There is no reason why it has to be along the A34 if another alternative exists. This is raised because the design of the Stanley Road junction provides for eastbound cyclists around the north of the junction and westbound cyclists around the south side. There are no facilities linking the two sides of the junction. This design makes the west to south and south to east turns difficult as they are not provided for. However, there are two alternatives to the path along the A34: to the west there is Earl Road and to the east the private Longsight Lane. Both of these could make links between Stanley Road and the A555. Longsight Lane would be the safer and more pleasant option. It is recommended that the Council pursue the option of adopting Longsight Lane as a cycle link between Stanley Road and the A555.

Stanley Road / A34 Junction

Cycle movements along Stanley Road are catered for by uni-directional facilities north and south of the junction. The eastbound route on the north side of the junction includes an offset toucan crossing. This increases the length of cyclists and pedestrian journeys and involves an additional stop with associated capacity lost for motor vehicles and potential for shunt and other accidents including see-through problems. The drawing supplied shows that the western approach to the junction is divided into two lanes with the left hand lane marked for turning left and the right hand lane for all other manoeuvres. If this is the case the two flows can be split by a triangular island allowing the offset toucan to be incorporated into the junction giving shorter journeys, a safer crossing and a pedestrian cycle crossing opportunity per signal cycle. It is recommended that this be investigated.



Diagram 14
Stanley
Green
Junction

The transitions between the carriageway and foot/cycleway should be smooth so that a cyclist can leave the carriageway without having to slow appreciably and return to the carriageway in a protected cycle 'slip' lane. The foot/cycleway should be locally widened at the ends of the toucan crossings by providing a short length of retaining wall. Additionally, cranked poles should be used to increase the available width.

A34/A555 junction

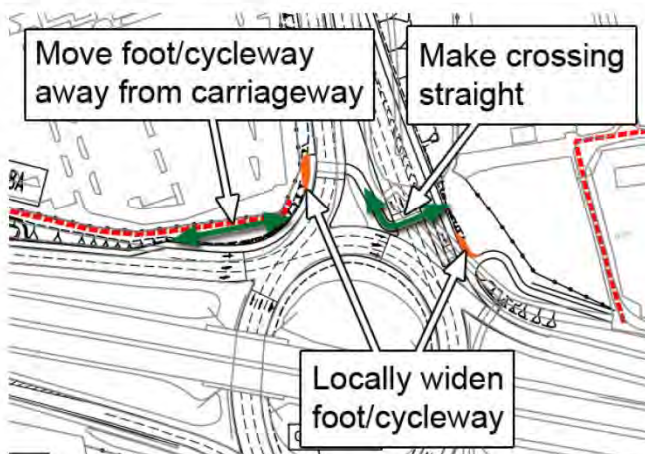

Diagram 15 A34/A555

The main concern with this junction is the stagger on the crossing of the southbound A34 approach. The 'sheep pen' on the island separating the left turn and straight ahead flows is long. Its width cannot be measured from the drawing supplied. Making the crossing straight has however, capacity implications.

The foot/cycleway should be locally widened at the ends of the toucan crossings.

The foot/cycleway could be moved away from the carriageway on the north west corner of the junction and combined with footpath 38A.

At the user group meeting held in Fred Perry House on Wednesday 18th September consultees expressed a view that the A34 junction is an appropriate place for a grade separated crossing. A bridge appeared to be the favoured option. However, with both Spath Lane and Earl Road being lower than the A34, a subway is likely to provide a better, more convenient crossing for cyclists and other route users. It would have shorter ramps than a bridge. It is recommended that the Council investigate a subway as well as a bridge at this point.

Plan 208

Wilmslow Road junction

The drawing supplied does not show any facilities to cross Wilmslow Road however, following discussions with Stockport Council, it is understood that a toucan will be provided. This toucan is a welcome addition to the proposals, though at this stage no comment on the details of its design can be made.

There are also no facilities shown for cyclists travelling along Wilmslow Road. As the turning movements at the roundabouts are simple it is recommended that the Council investigate whether green coloured on-carriageway cycle lanes or other markings would improve safety by highlighting the presence of cyclists.

The Relief Road west of Wilmslow Road

The foot/cycleway runs adjacent to the kerb for the length of the slip road. The Council should investigate whether a verge can be introduced sooner. It may be possible to run the foot/cycleway at the top of the cutting, which would also reduce the works at the Yew Tree footbridge.

Plan 209

Styal Road Junction

This junction is similar in layout to the Macclesfield Road junction but as there is a cycle route along the western footway of Styal Road there is no need to provide for cyclists on the carriageway nor the turns between on carriageway routes and the east-west foot/cycleway (as needed at Macclesfield Road).

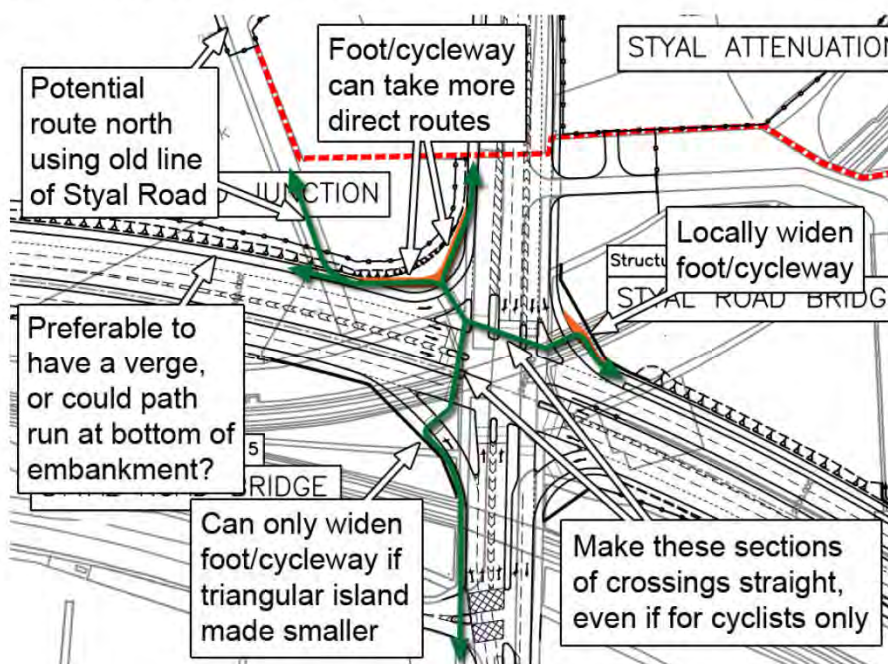

Diagram 16

Styal Road junction

Cycles should be signalled across the junction in fewer stages. Making assumptions about the signal sequencing it should be possible for cyclists to cross the junction in two stages. Cyclists travelling south to east and vice versa will require an additional stage. The foot/cycleway should be locally widened at the ends of the crossings. On the south west corner of the junction the bridge constrains the available width. The Council should consider whether the triangular island should be made smaller to enable the foot/cycleway to be widened here. On the north west corner of the junction the foot/cycleways could take a more direct route and arrive at the kerb edge in line with the crossing.

It is recommended that the Council considers how to reduce the number of stages involved in the cycle crossings, that the foot/cycleways are locally widened at the ends of crossings and that paths on the north west corner of the junction are straightened and made more direct.

West of Styal Road the Relief Road foot/cycleway is directly adjacent to the carriageway. It is recommended that there be a verge or strip of contrasting material along the kerb edge.

Further north on Styal Road (and outside the direct scope of this scheme) the cycle route crosses the Styal Road / Ringway Road junction by an uncontrolled crossing within the signals. This crossing is not the easiest to use. The Relief Road will result in less traffic using Ringway Road which would make the crossing easier. However, Manchester City Council is recommended to consider moving the cycle route to the old line of Styal Road: firstly, land

requirements for the Relief Road means that the whole length is back in public ownership; and, secondly, it will be safer to cross Ringway Road away from the Styal Road signals.

Relief Road west of Styal Road

The current design shows the foot/cycleway running alongside the Relief Road. According to the Design Team the path is a 3.0m shared space adjacent to the carriageway. There should be a verge or barrier between a cycle / pedestrian path and the carriageway. As the rest of the path is 2.5m wide it would seem reasonable and consistent that this section of path could be the same width giving space for a 0.5m verge. A verge has a larger maintenance liability than a macadam path. If this additional liability is considered a problem the “verge” could be a 0.5m deterrent strip of different contrasting material. It is therefore recommended that a verge or contrasting strip of at least 0.5m is constructed between the cycle path and the carriageway.

The route would be more useful if it was better integrated with Ringway Road, Shadow Moss Road and the residential areas in south Wythenshawe. Stockport Council has indicated that the emergency access from Ringway Road to the new road could be used by cyclists and pedestrians. If the link was for cyclists and pedestrians only the design would include measures to prevent cyclists failing to make the turn onto the cycle path and entering the carriageway in error. This could be done either by erecting a barrier near the kerb edge or by designing the junction so that cyclists are guided either left or right before joining the path, for instance by designing the junction in the form of a triangle. As the link is to be used by emergency vehicles then a barrier defeats the object of the link. It may be feasible to design the junction with a route for emergency vehicles running over deterrent paving with a smoother route for cyclists and a barrier at the kerb edge. It is recommended that Manchester City Council investigate measures to improve the links between the Relief Road cycle path and south Wythenshawe.

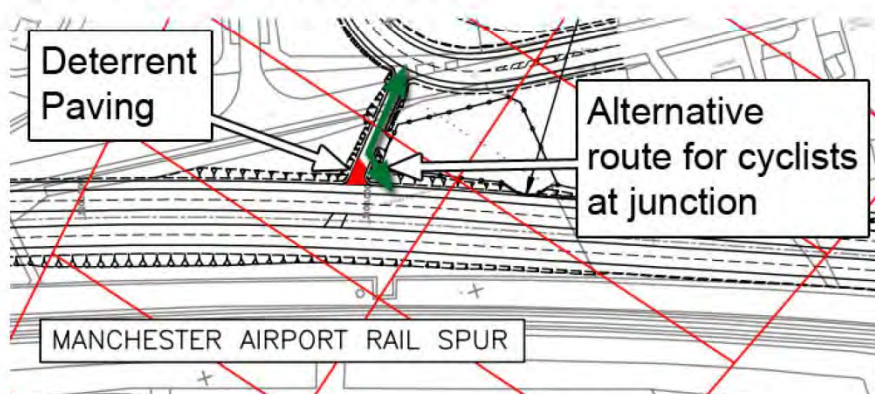

Diagram 17 – issues at the junction of the emergency access and cycle / pedestrian path.

Recommendations

Page	Plan no.	Location	Recommendation
4	209	West of Styal Road	Manchester City Council should consider the option of moving the path further away from the line of the road.
5	General	Access Ramps	Stockport Council should consider altering the alignment of the junctions where access ramps meet the Relief Road cycle pedestrian path.
5	General	Access Ramps	Stockport Council should move the bollard to a straight section of path. The gap between the bollards should be 1.2m minimum and the line of bollards should extend beyond the width of the path as vehicles can drive around them.
6	General	Ends of crossing points	Where possible paths at the end of crossings should be locally widened. Where they are in cuttings or on embankments this may require a short length of retaining wall. Consideration should be given to using cranked rather than straight poles to minimise intrusion into the available path width.
6	General	Transitions between carriageway and foot / cycle path	Stockport Council should pay particular attention to the ability of cyclists to leave and join the carriageway safely at the ends of the scheme.
7	201	Western junction with Buxton Road	The scheme should include a toucan crossing and new length of path to enable cyclists to turn right and rejoin the old alignment here.
7	201	Eastern junction with Buxton Road	Stockport Council should install an advanced stop line at this junction to make the right turn easier.
8	201	Eastern junction with Buxton Road	Stockport Council should convert the footway from the end of the new cul de sac to the Middlewood Way to joint pedestrian and cycle use. Parts of the footway will require widening.

Page	Plan no.	Location	Recommendation
8	201	Buxton Road (old line) / Middlewood Road	Stockport Council should lay a short length of green coloured advisory cycle lane across the mouth of the junction.
8	202	Old Mill Lane	Stockport Council should review the direction of this ramp between Old Mill Lane and the Relief Road.
8	202	Macclesfield Road	Stockport Council should redesign the north side of the Macclesfield Road junction so that the cycletrack along the line of the road crosses the junction in fewer stages.
9	202	Macclesfield Road	The advanced stop lines should be removed from the proposals.
9	202	Macclesfield Road	Stockport Council should abandon the central cycle lane and instead route cyclists via a widened footway on the west side of the road, crossing the left turn movement using a 'jug handle' accessed toucan crossing.
10	202	Macclesfield Road	Stockport Council should consider how turns between the off-carriageway east west route and the on-carriageway north south route can be facilitated.
10	204	Woodford Road Bridge	Stockport Council should ensure that the first 0.5m at the kerb edge of the foot / cycleway is made from a contrasting material.
10	204	Woodford Road Bridge	A flush dropped kerb should be provided at the top of the ramp to the Relief Road path for cyclists wishing to travel to or from the north east.
10	204	Woodford Road Bridge	Stockport Council should realign the foot / cycleway at the south western end of the bridge to make it easier for cyclists and horse riders to align themselves at right angles to Woodford Road.
11	205	Oil Terminal junction	Stockport Council should consider the need for guardrailing to enforce use of the chicanes or review the need for the chicanes themselves.
12	205	Oil Terminal Junction	Stockport Council should consider the safety implications of having an additional stopline set away from the Oil Terminal junction.

Page	Plan no.	Location	Recommendation
12	205	Chester Road	Stockport Council should reconsider the south west to east cycle right turn at the junction.
13	205	Chester Road	Stockport Council should improve the links between the old and new alignments.
14	205	Woodford Road	Stockport Council should investigate the possibility of making the crossing over Woodford Road a two stage crossing rather than a three stage one.
15	205	Woodford Road	Stockport Council should revise and re-align the path towards the Oil Terminal junction to provide a shorter, more direct route.
15	205	Woodford Road	If more carriageway space becomes available Stockport Council should investigate measures to provide for northbound cyclists on the carriageway and to consider either a short central cycle lane or 'jug handle' facilities to enable cyclists to avoid left turning traffic.
15	207	Longsight Lane	Stockport Council should pursue the option of making Longsight Lane a cycle link between Stanley Road and the A555.
16	207	Stanley Road	Stockport Council should investigate whether the offset crossing on the northbound exit can be incorporated into the junction.
16	207	Stanley Road	Stockport Council should ensure that the transitions between the carriageway and foot/cycleway are flush so that a cyclist can leave the carriageway without having to slow appreciably and return to the carriageway in a protected cycle lane.
16	207	Stanley Road	The foot/cycleway should be locally widened at the ends of the toucan crossings by providing a short length of retaining wall.
16	207	Stanley Road	Stockport Council should consider cranked poles to minimise the intrusion of signing poles on path widths.
16	207	A34	The foot/cycleway should be locally widened at the ends of the toucan crossings
17	207	A34	Stockport Council should investigate a subway as well as a bridge to enable cyclists to cross the A34.

Page	Plan no.	Location	Recommendation
17	208	Wilmslow Road	Stockport Council should investigate whether green coloured on-carriageway cycle lanes or other markings would improve safety by highlighting the presence of cyclists travelling in a north – south direction.
18	209	Styal Road	Stockport Council (as designers) should consider how to reduce the number of crossing stages involved in the cycle crossings through this junction
18	209	Styal Road	The foot/cycleways at this junction should be locally widened at the ends of the toucan crossings.
18	209	Styal Road	The paths on the north west corner of the junction should be straightened to make them more direct.
18	209	West of Styal Road	Manchester City Council should consider moving the north south cycle route to the old line of Styal Road.
19	209	West of Styal Road	Manchester City Council should construct a verge or contrasting deterrent strip of at least 0.5m between the cycle path and the carriageway.
19	209	West of Styal Road	Manchester City Council should investigate measures to improve the links between the Relief Road cycle path and south Wythenshawe.

Appendix

GREATER MANCHESTER CONCISE CYCLE & PEDESTRIAN AUDIT

HIGHWAYS SCHEMES

FACILITY	COMMENTS	
New Signal Junction	<ul style="list-style-type: none"> • Can cyclists and pedestrians make all movements easily? • Have approach lanes and Advanced Stop Lines (ASLs) been provided? • Can bypass lanes be provided for any cycle movements? • Can cyclists turn right easily? • If left turn filters are used, can a lane be provided to help cyclists to go straight on? 	<ul style="list-style-type: none"> • Cyclists and pedestrians can make all the necessary movements at most junctions. The scheme does not cater for turns between the Relief Road and Macclesfield Road. The audit has raised the issue of the number of steps required to cross some junctions. • Not at all junctions. The audit has recommended that ASLs be added to some approaches at some junctions but in cases where cyclists do not have to contend with conflicting movements they have been recommended for refusal. There is insufficient room in some case for approach lanes. • Where cyclists are catered for on the footway or on a separate cycle pedestrian path then there are cases where they have a bypass lane by default, e.g. left turn at signals, but there are no locations where a stand alone bypass lane needs to be provided. • Not at all locations. The difficulties of turning right have been highlighted at Buxton Road east & west junctions and the Chester Road link junction. • The scheme has provided lanes at Macclesfield Road but not at Woodford Road. Those at Macclesfield Road were recommended for removal because of their length and anticipated traffic speeds – it was felt that a jug handle crossing would be considerably safer. At Woodford Road the plans supplied showed insufficient room but the issue of crossing the left turn vehicle movement was raised by the audit.

- Have cycle detection loops been installed?
- Not shown on plans. Detailed design matter
- Can signal timings be altered to benefit vulnerable road users?
- Detailed signal design matter
-
- Have audible and / or tactile signals been installed?
- Detailed design matter

T-junction	<ul style="list-style-type: none"> • Have wide junction mouths been avoided where possible? 	<p>There are very few advisory T junctions in the scheme. At Buxton Road (old line) / Mill Lane and Buxton Road (old line) / Middlewood Road the mouth of the junction has been moved out into the carriageway away from the point where pedestrians cross. Although the radii of the corners has been increased pedestrians should benefit.</p>
	<ul style="list-style-type: none"> • Have pedestrian crossing facilities been provided? 	<p>Flows are relatively low at all the T- junctions.</p>
	<ul style="list-style-type: none"> • Have advisory cycle lanes been extended across junction mouths 	<p>Yes, at Buxton Road / Middlewood Road as flows out of Middlewood Road likely to be higher than those along Buxton Road.</p>

Roundabouts	<ul style="list-style-type: none"> • Can another form of junction control, such as signals, be used? • Can vehicle speeds be further reduced? • • Can a single lane circulatory system be used? • If not, has a peripheral cycle path been provided at large roundabouts? • Have pedestrian crossing facilities been provided? • Do facilities for pedestrians and cyclists minimise delay? 	<p>There are roundabouts at A34/Stanley Road, A34/A555 and Wilmslow Road. The cycle facilities at A34/Stanley Road and A34/A555 are signal controlled. At Wilmslow Road east west movements are catered for by a toucan crossing but north south movements use the roundabouts conventionally. The latter junction could probably be signalled but it is assumed that this was investigated during the initial design stages and rejected.</p> <p>The toucan crossing will reduce speeds slightly at Wilmslow Road. The Council have been recommended to consider on carriageway cycle lanes and these would have an effect of reducing speeds by reducing the visibly available carriageway space.</p> <p>There may be capacity issues at Wilmslow Road not discussed with the designer.</p> <p>On carriageway lanes recommended. No room for a peripheral cycle path at Wilmslow Road.</p> <p>Yes in the east west direction at Wilmslow Road.</p> <p>Delay to east west cyclists depend on the signal timings which will be a final design matter.</p>
--------------------	--	---

New Zebra or controlled crossing	<ul style="list-style-type: none"> • Has puffin crossing been considered rather than a zebra, for pedestrian only routes? • Has a toucan crossing been installed if crossing point is on strategic or local cycle network? • Has tactile paving been installed? • Does crossing conform to latest guidance? 	All crossings are signalled and all crossings on cycle routes are toucans. Other questions are detailed design matters
New refuge / island	<ul style="list-style-type: none"> • Is crossing depth to at least 2m (to allow cyclists to wait on refuge) and crossing width 3m or 4m (to allow cyclists/pedestrians to pass) if on the cycle network? • If insufficient room for refuge, can a controlled crossing be implemented instead? • Has a high quality cycle bypass been provided if refuge / island creates a pinch point on a high speed road (40mph or above)? 	<p>The audit has recommended refuge islands to assist cyclists cross Chester Road near the link road junction. The recommended width in the audit has been 2.5m</p> <p>Not an issue here</p> <p>Not an issue here as cyclists provided for off carriageway.</p>
Cycle Lanes	<ul style="list-style-type: none"> • If multiple traffic lanes exist, can one be removed to create room for cyclists? 	Cyclists are mostly provided for off the main carriageway of the scheme. In other places room (where it exists) has been left for a cycle lane.
	<ul style="list-style-type: none"> • Is lane width 2m (or a minimum of 1.5m) for a long length? Local narrowing below 1.2m is acceptable to ensure continuity of cycle lane. 	Detailed design matter
	<ul style="list-style-type: none"> • Is there sufficient space next to parking/loading areas? 	There are no loading or waiting areas in the scheme
	<ul style="list-style-type: none"> • Are mandatory lanes or no-waiting TRO necessary if parking problems exist? 	There should be no areas with parking problems on the scheme
	<ul style="list-style-type: none"> • Can advisory lanes be extended through pinch points? 	There are no pinch points within the scheme. There are narrowings where the scheme meets the existing highway network. Critical points (mostly Woodford Road) have been discussed with the design manager and references made in the audit.
	<ul style="list-style-type: none"> • Is green coloured surfacing necessary where conflict is likely to occur? 	There are several locations where green surface colouring has been recommended.
Inside/	<ul style="list-style-type: none"> • For carriageways where there is 	Cyclists are mostly catered for off

Nearside Lane Width insufficient space for a cycle lane, can the nearside traffic lane be at least 4.25m width? carriageway. Some locations (e.g. Macclesfield Road) lanes have been provided. At others (e.g. Woodford Road bridge) the carriageway will be approximately its existing width.

One-Way Street	<ul style="list-style-type: none"> • Would a contra-flow cycle lane be appropriate, especially if the road is part of the cycle network? 	There are no one-way roads in the scheme.
Pedestrian / Shared use cycle paths adjacent to carriageway	<ul style="list-style-type: none"> • Has on-road provision, with traffic volume and speed reductions, been considered? • Has the route been given priority over driveways and accesses, and can it be given priority at side roads at side roads? • Has parking on the path been prevented or discouraged? • • Has at least 1.5m width provided for pedestrians, and 2.0m for cyclists been provided, if segregated? • • Is the crossfall between 1 and 2%? • • Has correct signing, lining been provided? • • Are tactile markings required? • • Is 'cycle calming' necessary to reduce danger at possible points of conflict? • • Can cyclists join main carriageway at 90 degrees? • • Have cycle, pedestrian and disabled groups been consulted? 	<p>Probably a political decision to have off-carriageway facilities. The purpose of the road is to relieve existing roads so traffic reduction is not appropriate,</p> <p>The are few side roads with priority junctions in the scheme. The route passes these on carriageway. The off carriageway crossings are signalled.</p> <p>There is unlikely to be pressure for parking on the path.</p> <p>The path is unsegregated</p> <p>Detailed design matter</p> <p>Detailed design matter</p> <p>Not along the route as it is unsegregated. Markings at junctions and where pedestrian only routes join the path are a matter for detailed design.</p> <p>Inappropriate on a road of this nature.</p> <p>90 degrees is not appropriate at all transitions to and from the carriageway. Each location has been considered individually.</p> <p>Yes. Continuous process of consultation.</p>

Off-highway routes	<ul style="list-style-type: none"> • Has status of cycle path been determined as adopted highway, bridleway, cycle track or concessionary? 	Unknown.
	<ul style="list-style-type: none"> • Has adequate width been provided if shared use? 	Yes. While 2.5m is below the recommended width in LTN1/12 there is a generous verge and the width is more than adequate for the expected flows.
	<ul style="list-style-type: none"> • Have drainage problems been addressed? • 	Detailed design matter
	<ul style="list-style-type: none"> • Is surfacing all-weather, easy to maintain, comfortable, skid-resistant, appropriate to the path's status and sympathetic to the surroundings? • 	Detailed design matter
	<ul style="list-style-type: none"> • Has correct signing, lining been provided? • 	Detailed design matter
	<ul style="list-style-type: none"> • Are tactile markings required? • 	Not along the path. Required at junctions but a matter for detailed design.
	<ul style="list-style-type: none"> • Is lighting required, especially if a commuter route? • 	Overspill from main carriageway should be adequate where cycle route is not adjacent to the carriageway
	<ul style="list-style-type: none"> • Can cyclists join main carriageway at 90 degrees? • 	90 degrees is not appropriate at all transitions to and from the carriageway. Each location has been considered individually.
	<ul style="list-style-type: none"> • Have cycle, pedestrian and disabled groups been consulted? 	Yes. Continuous process of consultation.
Traffic Calming	<ul style="list-style-type: none"> • Have vertical deflections for cyclists been avoided (whilst maintaining effect on cars), or cycle friendly deflections such as sinusoidal humps used (special authorisation may be required)? • Has a 1m gap (0.75m min) been left in between traffic calming features and the edge of the carriageway? • Have high quality bypasses been provided at pinch points? 	No traffic calming in the scheme.
Road Closure	<ul style="list-style-type: none"> • Can safe pedestrian and cycle access be maintained, both physically and in TROs? 	Where roads, footpaths and bridleways have been closed the scheme provides for a bridge or alternative route.

Drop kerb	<ul style="list-style-type: none"> Is kerb flush, and has tactile paving been provided for pedestrians if on a pedestrian route? 	The design specification provides for a 6mm maximum upstand. Tactile paving is a detailed design matter
Bus Lay-by	<ul style="list-style-type: none"> Is upstand flush between carriageway and lay-by? 	The design specification provides for a 6mm maximum upstand.
Bus Lane	<ul style="list-style-type: none"> Is the lane width 4.25-4.6m to allow buses and cyclists to overtake each other? 	No bus lanes on scheme.
Drainage	<ul style="list-style-type: none"> Are any conventional gullies located at pinch point or pedestrian crossing point? Alternative gully design or location may be required. Have gully grates been replaced if bars run parallel to kerb? 	Detailed design matters.
Signs, lighting and street furniture	<ul style="list-style-type: none"> Are signs mounted at at least 2.4m ? Is all street furniture necessary? Is street furniture consistent in style and colour? Is all signing, lighting columns and street furniture, including bus stops, arranged to minimise clutter, and outside the path? Are destinations signed for pedestrians and cyclists? Is lighting adequate for visually impaired people? 	Detailed design matters.
Cycle Parking	<ul style="list-style-type: none"> Does installation comply with spacing specifications and security issues? 	It is unlikely that cyclists will need to park along the route. Detailed design matter.

Appendix D

Stage 1 Road Safety Audit

Appendix D.1

Stage 1 – Feasibility Road Safety Audit

**STOCKPORT METROPOLITAN BOROUGH COUNCIL
ENVIRONMENT AND ECONOMY DIRECTORATE**

STAGE 1 - FEASIBILITY ROAD SAFETY AUDIT

For the attention of Naz Huda

Scheme – SEMMMS A6 to Manchester Airport relief road

Date of Site Visit – 4th October 2013

Weather Conditions – Fine & Dry

Copies to – Steven Payne.

The attached report is the Stage 1 / Feasibility Road Safety Audit for the above scheme based on the following information supplied to the Crash Investigation Team.

Item	Description	Supplied	Comments
A	Plans	Yes	1007/3D/DF7/A6-MA/GA/200 – 209
B	Traffic Count Data	No	
C	Speed Count Data	No	
D	Accident Data	Yes	Supplied by CRASH team
E	Design Standards	No	
F	Design Brief	No	
G	Other Data	yes	

The Road Safety Audit has been conducted in accordance with Stockport Councils Road Safety Audit Procedure, adopted 1st May 2006. In particular, it is based on the Highways Agency's Design Manual for Roads and Bridges HD19/03 which supersedes the previous Standards HD19/94 and Advice Note HA42/94. It also has regard to the Institution of Highways and Transportation reference document, 'Guidelines for the Safety Audit of Highways'.

Stuart Jackson
Service Director
Place Management

Traffic Services
Crash Investigation Team
Stopford House
Piccadilly
Stockport SK1 3XE

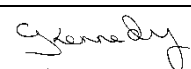
	Author	Road Safety Manager	Traffic Services Manager
Signed			
Date	07 th Oct 2013		

Scheme	SEMMMS A6 to Manchester Airport relief road	
Crash Investigation Team reference	ES1-626 / 43123	
DOMS No.	1007	
Audit Brief Submitted by	SEMMMS Team 3 rd October 2013	
Contact	Naz Huda	474 4835
Audit Team	Gary Kennedy	07800 618190
	Richard Clark	0161 474 4837

1.0 Introduction

- 1.1 This Stage 1/ Feasibility Road Safety Audit, examines the road safety implications associated with the SEMMMS relief road design, and the associated proposed improvement works.
- 1.2 The comments contained in this Safety Audit are based on the information on the drawings provided and on a site visit carried out on 4th & 7th October 2013.
- 1.3 Incident data – due to problems with the GMAXI and GM accident plus databases it has not been possible to access the last 3 years current incident records for the route for this RSA report. However historical data has been analysed from 2010 (ES1/530 report - SEMMMs – A6 to Airport – Design Freeze 3 (May 2010) as part of the previous stage 1 audit review.

2.0 The Safety Audit

The Audit Team, because of the detail provided in the drawings have carried out a Feasibility / Stage 1 Road Safety Audit. The Audit team have considered visibility, levels, turning manoeuvres, alignment and facilities for non-motorised users as part of the audit process.

Note

There has been no exception report received from previous stage 1 RSA (43084) submitted on the 20th June. Some of the problems / recommendations are still relevant to this RSA and are highlighted**

2.1 Plan 1007/3D/DF7/A6-MA/GA/201

**Problem 1

Location: Buxton Road / relief road pedestrian crossing design

Summary: hatched area on the approach to the controlled facility

Current best practice guidance from GMUTC indicates there should be central islands on both approaches within the hatched area at the end of the right turn pockets.

Recommendation 1

All the following recommendations are made with a caveat as they will each have differing safety implications:

- i. Move the proposed islands or provide smaller 'D' islands away to within the hatched area adjacent to the crossing to prevent the possibility of any vehicle overtaking a stationary vehicle and compromising the safety of pedestrians at the crossing.
- ii. Remove the turning pocket and therefore there will be no need to provide central islands.
- iii. Make an application for a departure from standard and have no 'D' islands as this option would conflict with current guidance.

**Comment A

Location: Safety Camera on Buxton Rd near Alma Rd

Summary: Consider relocating

There is a traffic speed enforcement camera located near to the junction with Alma Road; that will become redundant due to reduced speeds and volumes of traffic.

Recommendation A

Liaise with the Camera Partnership and identify suitable alternative location for the camera.

2.2 Plan 1007/3D/DF7/A6-MA/GA/202

**Problem 2

Location: London Road North – Structure reference B004A

Summary: Alignment & length of right turn pocket (north – east)

There is a concern regarding the length of the right turn pocket north to east and the general arrangement that could cause confusion with vehicles entering the earlier pocket for the garden centre trying to filter back into general forward traffic flow.

Recommendation 2

It is recommended to extend the widening back to the island south of Norbury Court. This will allow the alignment to be moved slightly to the south and west and provide more room to clearly define lanes earlier. (2A) It is also suggested to provide a traffic island at the end of the right turn pocket (for the garden centre) to deter drivers from using the hatched area in order to enter the lane designated north to east onto the relief road.

2.3 Plan 1007/3D/DF7/A6-MA/GA/203

**Problem 3

Location: Access Roads either side of Mill Hollow Bridge

Summary: Access / Egress from the relief road (50mph) – increase nose to tail shunts

The standard access arrangements shown will mean that vehicles have to slow considerably entering the access road and / or accelerate quickly and leaving to join traffic travelling at 50mph

Recommendation 3

The detail design proposals should determine expected frequency and type of vehicle use. It may be appropriate to incorporate acceleration / deceleration feeder lanes or to widen the accesses.

2.4 Plan 1007/3D/DF7/A6-MA/GA/204

No safety related problems or recommendations

2.5 Plan 1007/3D/DF7/A6-MA/GA/205

**Problem 4

Location: Lay-by near to attenuation pond east of structure ref B003

Summary: Access / Egress from the relief road (50mph) – increase nose to tail shunts

The layby is situated at the point where the new road reduces from three lanes to two. As the layby is very short it will be difficult to accelerate away and could result in an increase in side impact collisions.

Recommendation 4

The detail design proposals should determine expected frequency and type of vehicle use. It may be appropriate to extend the layby length to allow vehicles to filter in more easily; relocate or move the point at where the 3 lanes become two east prior to the layby.

2.6 Plan 1007/3D/DF7/A6-MA/GA/206

No safety related problems or recommendations

2.7 Plan 1007/3D/DF7/A6-MA/GA/207

****Problem 5**

Location: A555 exit onto A34 North west corner

Summary: Left turn lane (West to North) pocket

The left turn exit lane from the A555 onto the A34 is much shorter than any of the others on the four arms of the roundabout; is this because of expected demand or site constraints?

Recommendation 5

It is accepted that the alignment may be limited by site constraints; however if it is feasible it is recommended to extend the lane by moving the start of the lane back to the west and providing a reduced taper angle to ease traffic into the lane earlier.

Problem 6

Location: A34 exit onto A555 North East corner

Summary: Removal of pedestrian controlled facility

The previous design layout plan1007//3D/TR1/A6-MA/GA/007 had a pedestrian controlled facility across this arm of the junction which meant pedestrians could safely cross the east side of the roundabout following the footpath.

It now appears that pedestrians will have to take a more circuitous route across the centre of the roundabout to the west side and then cross back over to the east on the north side of the junction.

Recommendation 6

It is recommended that the controlled facility should be re-instated to allow pedestrians to safely cross the east side.

2.8 Plan 1007/3D/DF7/A6-MA/GA/208

****Problem 7**

Location: Clay Lane junction to Slip Road

Summary: Cross roads junction near to roundabout Wilmslow Road – potential incident problem.

The Clay Lane junction is very close to the roundabout and raises concerns with regard to vehicles exiting across the slip road being hit side on by vehicles accelerating down the slip road to join the relief road (50mph). There is also the potential for nose to tail incidents from vehicles turning left into / and out of Clay Lane.

Recommendation 7

It is recommended that this access point to and from Clay Lane is removed from the proposals and that improvements are made to the Kingston Road / Wilmslow Road (B5358) junction.

2.9 Plan 1007/3D/DF7/A6-MA/GA/209

**Observation B

Location: Access Point

Summary: Intention of use

There is an access point to the relief road east of FP7; it is not clear whether this is for vehicle access or not.

Recommendation B7

Detail design proposals should indicate whether this is intended for vehicle use.

3.0 Further Safety Audits

- 3.1 The scheme should be subject to further Road Safety Audits, Stages 2 & 3 before being commissioned and opened to traffic.

4.0 Conclusion

- 4.1 This Stage 1 Road Safety Audit recommends various actions, which should be addressed in the detailed design process, prior to construction. Where recommendations cannot be incorporated into the design, they should be documented in an **exception report** that should be forwarded to the CRASH Investigation Team.

5.0 Audit Team Statement

I certify that this audit has been carried out in accordance with Stockport Councils Road Safety Audit Procedure, adopted 1st May 2006.

AUDIT TEAM LEADER:

Name: Gary Kennedy

Signed:

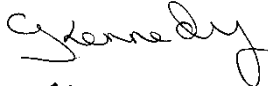

Position: Senior Traffic Services Officer Date: 7th October 2013

Organisation: Stockport Metropolitan Borough Council, Stopford House, Piccadilly,
Stockport, SK1 3XE

AUDIT TEAM MEMBERS:

Name: Richard Clark

Position: Road Safety Manager

Signed:

Organisation: Stockport Metropolitan Borough Council, Stopford House, Piccadilly,
Stockport, SK1 3XE

Appendix D.2

Engineers Response to Stage 1 Road Safety Audit

SEMMMS A6 to Manchester Airport Relief Road Engineers Response to Stage 1 Road Safety Audit

Scheme:	SEMMMS A6 to Manchester Airport Relief Road	
Original Crash Investigation Team Ref:	ES1-626/43123	Date: 7 th Oct 2013
Engineer:	Steven Payne	Date: 8 th Oct 2013
Checked:	Naz Huda	Date: 8 th Oct 2013

1.0 Introduction

1.1 This document is in response to the second Stage 1 Feasibility Road Safety Audit (RSA) carried out in Oct 2013 by Stockport Metropolitan Borough Council Crash Investigation Team. This second RSA has been carried out due to significant changes to the proposed scheme layout. The RSA examined the road safety implications associated with the SEMMMS relief road design and associated proposed improvement works.

1.2 The problems and possible solutions highlighted in the Stage 1 RSA have been carefully considered in relation to the individual locations. The SEMMMS Design Team responses to each issue explain the rationale behind the original design and whether the RSA recommendations will be integrated into the proposed design.

2.0 Plan 1007/3D/DF7/A6-MA/GA/201

Problem1: A6 Buxton Road, hatched area on approach to pedestrian controlled facility should contain central islands.

Response: The present layout proposal has two central islands within the hatched areas protecting the right turn lanes into Hazel Grove Golf Club and Yew Tree Avenue, with the signalised Toucan crossing positioned in the middle. Given the proposed speed limit of 30mph and the close proximity of the islands it is considered that the present proposal be retained with the additional inclusion of "D" islands, as recommended, within the hatched area either side of the crossing.

Comment A Response: The SEMMMS Design Team has contacted the Camera Partnership to make them aware of the changes to the existing camera location. At the time of compiling this document no response has been received.

2.1 Plan 1007/3D/DF7/A6-MA/GA/202

Problem2: Macclesfield Road/Relief Road Junction Layout. Right turn from Poynton onto the relief road could be confused with the right turn lane into Brookside Garden Centre.

Response: The recommendation to extend the widening back to the proposed central island south of Norbury Court to provide more room to clearly define traffic lanes earlier is not

SEMMMS A6 to Manchester Airport Relief Road Engineers Response to Stage 1 Road Safety Audit

considered suitable at this location. The present junction layout provides adequate queuing capacity within the public highway whilst mitigating private land take. The issue of right turning drivers queuing back from the junction and using the garden centre right turn lane would not occur according to predicted peak traffic queues for scheme opening year 2017 and design year 2032. However, the introduction of a physical island between the right turn lanes for the garden centre and the main junction right turn lane will be re-considered at detailed design stage.

2.2 Plan 1007/3D/DF7/A6-MA/GA/203

Problem3: Mill Hill Hollow – Access/egress to balancing ponds causing nose to tail shunts.

Response: The left turn in and left turn out vehicle manoeuvres would be of an extremely infrequent nature. The type of vehicle expected to use these access points would be a Van/Land Rover with trailer or similar. Both the vehicle type and frequency of use will be determined by the highway maintenance authority (SMBC or CEC). The lockable barriers preventing public access would be positioned back from the relief road ensuring maintenance vehicles are off the highway and prevent the rear end collisions outlined in the RSA. The proposed relief road geometry on both approaches to Mill Hill Hollow allow for forward visibility in excess of the Desirable Minimum required within DMRB, which will provide road users with ample warning of slow turning vehicles or obstructions in the road ahead.

2.3 Plan 1007/3D/TR1/A6-MA/GA/205

Problem4: Lay-by adjacent to attenuation pond at Woodford Road, Bramhall –Access/egress to lay-by causing nose to tail shunts.

Response: The lay-by is located to provide a hard standing off road parking area for attenuation pond maintenance vehicles. The design team recognise the concerns outlined in the RSA and will review access arrangements to this area at detailed design.

2.4 Plan 1007/3D/DF7/A6-MA/GA/207

Problem5: A555 eastbound diverge slip onto A34 northbound is very short.

Response: The eastbound diverge slip road has been designed to accommodate predicted peak traffic flows for scheme opening year 2017 and design year 2032. The length of the dedicated (short) left turn lane provides sufficient capacity.

Problem6: A34 exit onto eastbound merge slip road and the removal of the pedestrian crossing facility on the east bound merge slip road.

Response: Following a review of the proposed junction layout by SMBC Network Manager, it was requested that the design team remove, where feasible, any controlled or uncontrolled crossing facility located on the exit arms of this junction on safety grounds. It was agreed to integrate the crossing locations with signal locations to use the “stop phase” to facilitate a

SEMMMS A6 to Manchester Airport Relief Road Engineers Response to Stage 1 Road Safety Audit

controlled crossing movement. Additional traffic engineering work was carried out in respect of signal phasing to check the design proposals resulting in the present layout.

2.5 Plan 1007/3D/DF7/A6-MA/GA/208

Problem7: Clay Lane/Wilmslow Road Junction layout – potential incident problem.

Response: The present junction layout was adopted from Cheshire East Council proposals (formerly Cheshire County Council). There is a requirement/agreement in principle that Clay Lane would continue to have direct access to Wilmslow Road. The proposed westbound merge slip road starts at the junction with Clay Lane while the proposed speed limit is still 30mph and vehicles will still be travelling at reduced speeds as they come off the adjacent roundabout. The recommendation to close direct access to Clay Lane from Wilmslow Road and re-route via Kingston Road is not an option previously considered. However, the design team recognise the issues raised and will review the junction proposal with the wider project team. The design/project team will confirm with the highway authority (CEC) the direct access requirements for Clay Lane, and will review the junction layout according to the highway authority's response.

2.6 Plan 1007/3D/DF7/A6-MA/GA/209

Observation B: Access Point east of FP7 – Unknown intention of use

Response: The access referred to above is for left in/left out field access and Styal Railway Bridge Maintenance access. Lockable barriers preventing public access would be positioned back from the relief road ensuring maintenance and farm vehicles are off the highway to prevent rear end collisions. The proposed relief road geometry on the approach to this location provides forward visibility in excess of the Desirable Minimum distance required within DMRB, which will provide road users with ample warning of slow turning vehicles.

Appendix E

Development Assumptions

2017 Core Scenario Cheshire East

Reference	Site	Type	Location	Floorspace (sqm) / Dwellings	Description	Easting	Northing	Uncertainty by 2017
2	Tytherington Business Park remaining plots on phases 1 & 2	Employment	Springwood Way, Macclesfield	Circa 28,000 B1a remaining	Large greenfield site allocated in Local Plan. High quality business park principally for B1 uses.	392261	375965	More than likely
13	Knutsford Supermarket	Retail	Brook Street, Knutsford	1,560 food retail	Edge of centre redevelopment site	375500	378483	Near certain
14	Macclesfield District General Hospital Blue Zone	Housing	Cumberland Street, Macclesfield	67 dwellings, 75-bed care home, 550 sqm retail and 3,600 sqm office block	Surplus hospital land	390977	373935	Near certain
19	Henbury High School Site	Housing	Whirley Road, Macclesfield	123	Former school site	389080	373747	Near certain
24	Ingersley Vale	Housing	Bollington	66	Underused industrial site	394231	377362	Near certain
26	Land near former Old Kings Head PH	Employment	Chestergate, Macclesfield	576 A1	Brownfield town centre site	391525	373809	Near certain
27	Unit 8	Retail	Lyme Green Retail Park, Macclesfield	3,179 gross, 1,683 net A1	Brownfield out of centre retail park unit	391509	371165	Near certain
28	Curry's Ltd	Retail	Lyme Green Retail Park, Macclesfield	560 A1	Brownfield out of centre retail park unit	391409	371133	Near certain
29	Unit 6	Retail	Lyme Green Retail Park, Macclesfield	1,352 gross, 720 net A1	Brownfield out of centre retail park unit	391448	371120	Near certain
30	AstraZeneca	Employment	Alderley House, Alderley Edge	6,256 gross	Erection of research building	384737	375562	Near certain
31	IFE Services Ltd	Employment	Haig Road / Mobberley Road, Knutsford	2,380 gross / 1,180 net	Demolition of existing buildings and erection of two new office buildings	376150	379507	Near certain
32	Land at Mottram Way	Employment	Macclesfield	1,903 gross / 654 net	Erection of two new buildings (phase 3) comprising six single storey units	392086	374855	Near certain
33	Rupert House	Employment	London Road South, Poynton	2522	Erection of two storey office building (b1) and five industrial storage and distribution units (b2/b8) with associated parking and turning areas.	391660	382521	Near certain
34	22-24 Manchester Road	Employment	Wilmslow	1,005 gross / 732 net	Demolition of existing buildings and erection of three-storey office building incorporating car parking and alterations to access	384897	381293	Near certain
35	Wycliffe House	Employment	Water Lane, Wilmslow	1,520	Erection of three storey extension for b1 office purposes and provision of additional decked car parking accommodation	384410	380995	Near certain

2017 Core Scenario High Peak

Reference	Site	Type	Location	Floorspace (sqm) / Dwellings	Description	Easting	Northing	Uncertainty by 2017
E1	Morrisons extension	Employment/Retail	Buxton	1253	Extension to existing supermarket	406575	372959	Near certain
E4	Tesco	Employment/Retail	Whaley Bridge	1249	Extension to existing supermarket	401291	382103	Near certain
E5	Howard Town Mill	Employment/Retail	Glossop	Supermarket – 1921 Mixed A1 non-food, A3 and A4 - 2517	Mixed-use scheme including A1 (food and non-food), A3 and A4.	403545	393983	Near certain
E6	Staden Lane	Employment/Retail	Buxton	B8 – 1168	Proposed chill store extension, pallet storage, office, canteen & staff facilities	407026	371986	Near certain
E7	Dinting Lodge	Employment/Retail	Glossop	B2 – 12,160	Extension to the NE corner of the main industrial building	401746	394826	Near certain
E8	Waterswallows Road	Employment/Retail	Buxton	B2 – 23,865	Construction of bottling plant and warehousing	407970	375375	Near certain

2017 Core Scenario Manchester City

Reference	Site	Type	Floorspace (sqm) / Dwellings	Comments/Location	Easting	Northing	Uncertainty by 2017
2	Sites at former Withington Hospital, West Didsbury	Housing	299	Housing sites under construction plus additional land identified as suitable. Total capacity around 299 units	381767	394489	Near Certain Complete
H2	Housing	Housing	50	Housing site under construction. Approx 50 units still to be completed	380633	389778	Complete
H3	Styal Road, Woodhouse Park	Housing	14 house, 135 apartments	Housing site partially complete. 147 units in total.	384201	385752	Near Certain
H4	Wastdale Road, Baguley	Housing	67	Housing site with expired permission, some works carried out in site preparation. Revised application submitted but withdrawn. Suitable for 50-70 units.	381059	387846	Near Certain
H5	Portway/Petheridge Drive, Woodhouse Park	Housing	88	Housing site under construction. 88 units.	381721	386363	Near Certain
H10	Tuffley Road, Rodborough Road	Housing	68	Planning Permission for 68 units	381024	387353	Near Certain
E4	Airport City approximately 30ha (predominantly proposed for B1 business and office use including advanced manufacturing, with complementary uses including, hotel, leisure, conferencing and possibly residential) at Manchester Business Park	Employment/Retail	15,000 / 30 ha	Planning Permission for 15,000sqm of office development	380548	385200	20 % Near Certain (office application) 80 % Reasonably Foreseeable (Airport City)
E5	Airport City approximately 30ha (predominantly proposed for B1 business and office use including advanced manufacturing, with complementary uses including, hotel, leisure, conferencing and possibly residential) at Manchester Business Park	Employment/Retail	B1 - 73,000, B2, B8, A1, C1, C3	Manchester Business Park allocated in the City of Manchester UDP for High Technology Industries	381779	385654	20 % Near Certain (office application) 80 % Reasonably Foreseeable (Airport City)
E6	Airport City approximately 30ha (predominantly proposed for B1 business and office use including advanced manufacturing, with complementary uses including, hotel, leisure, conferencing and possibly residential) at Manchester Business Park	Employment/Retail		To be identified as part of a strategic location in the Core Strategy	383379	385010	20 % Near Certain (office application) 80 % Reasonably Foreseeable (Airport City)
E8	New District Centre Baguley	Employment/Retail	A1, A2, A3, B1, C1,C2,C3	Identified in the draft Core Strategy	380288	389394	Near Certain
E9	New Town Centre Bus Station at Wythenshawe Hospital	Employment/Retail	0.54 ha	Submitted Planning application and funding in place	382770	387124	Near Certain
E11	3,120sqm of office planning permission on 0.39ha at Cedars, Wythenshawe	Employment/Retail	3,120 / 0.39 ha	Under construction for B1 offices.	382838	387328	Near Certain
E13	20,169sqm on 3.04ha site at Didsbury Point, Princess Road	Employment/Retail	20,169 / 3.04 ha	Planning permission for B1	383463	392501	Nearly certain
E15	Etrop Court 2 shops, 6206sqm on 0.94ha office B1 (District offices for the Local authority) at Rowlandsway, Wythenshawe	Employment/Retail	6206 sqm / 0.94 ha	Planning permission for B1	382713	387187	Nearly Certain
E16	Private Hospital @ Didsbury Point	Employment/Retail	15,500	Planning permission	383580	392651	Near Certain
E17	New Bus Garage, Stage Coach @ Longley Lane	Employment/Retail	4385 / 1.75 ha	Planning Permission	383405	389049	Near Certain
E18	Recycling Centre rebuild@ Longley Lane	Employment/Retail	7064		383662	389062	Near Certain

2017 Core Scenario Stockport

Reference	Site	Type	Location	Floorspace (sqm) / Dwellings	Site Area	Description	Easting	Northing	Plan Status	Uncertainty by 2017
E1	Cheadle Royal	Employment	Cheadle Royal Business Park, Cheadle	11,000 B1 office	2.84Ha	Major office development site with a number of consents and outline permission. Figure includes all land still available for development, with estimated floorspace	385340	385945	Allocation in Employment Area, with some full permissions to be implemented	Near certain
E2	Green Lane Industrial Area	Employment	Higher Bury Street, Stockport	574 B1 office	0.6Ha	Office development at vacant site	388661	390666	Full permission in employment area	Near certain
E3	Cheadle District Centre	Employment	Travis Perkins, Lime Grove, Cheadle	1,011 B8	0.51Ha	Redevelopment of existing site	385,699	388732	Employment site adjacent to district centre	Near certain
E4	Former Thomas Storey Site	Employment	Tiviot Way, Stockport	19,888 B2/ B8	6.6Ha	Development of a number of B2 and B8 units vacant employment site	389000	391000	Permission granted	Near certain
E13	Woodford	Housing	Former BAE site	250	25 Ha	There are a range of lawful uses within the site which can continue or could in principle be reintroduced without the need for a further grant of planning permission.	390800	382700	Vacant site within an approved SPD	More than likely
H1	Site of New Mill, Houldsworth Street	Housing	Reddish	291	2.77	Conversion and extension to existing mills to provide 383 units and 88 units in new 6 storey block - 471 in total. Phase I complete (180 flats) - hence no. of units given is 291. Phase II (123) started but has stalled. Phases III and IV may be scaled back.	389119	393678	Under construction	More than likely
H2	104, 106 Cross Lane and Park and Paterson Ltd	Housing	Marple	79	1.93	Application granted Oct 2010 for demolition of vacant foundry and ancillary buildings and redevelopment of site for 79 dwellings.	395025	388354	Under construction	Near certain
H3	Goyt Works, Station Road	Housing	Strines	96	2.5	Redevelopment to provide 96 houses and 2 employment units.	397410	386519	Under construction	Near certain
H4	Site A - Phase 2 (Former Bridgehall Sidings)	Housing	Bridgehall	150	4.9	Allocated housing site reclaimed using derelict land grant. New road access created and the site is now ready for redevelopment after being regraded and levelled.	388339	388720	Allocated housing site	More than likely
H6	Former Barnes Hospital, Kingsway	Housing	Cheadle	128	3.8	Conversion of vacant hospital buildings to create 42 flats and erection of 18 town houses and 68 flats.	385216	389011	Full planning permission	More than likely

Reference	Site	Type	Location	Floorspace (sqm) / Dwellings	Site Area	Description	Easting	Northing	Plan Status	Uncertainty by 2017
H7	Compstall Mills, Andrew Street	Housing	Compstall	121	1.55	The Planning Brief for this Major Existing Developed Site in the Green Belt lists housing as an acceptable use. Application submitted 22/6/09 for mixed use development including 121 residential units.	396550	390760	Application not yet decided	More than likely
H8	Hollands Mill site, 61a - 63 Shaw Heath	Housing	Town Centre	112	0.752	Outline application granted 20/04/2010 for mixed-use development of vacant site providing up to 112 residential units.	389515	389410	Outline planning permission	More than likely
H9	Hopes Carr Phase 1	Housing	Town Centre	90	1.2	Planning permission granted Mar 2010 for a total of 90 units and 2 retail units in line with approved masterplan for wider Covent Garden area.	389950	390240	Full planning permission	More than likely
H12	Dialstone Centre, Lisburne Lane	Housing	Offerton	90	3.5	Former secondary school converted to Council offices, training centre, leisure centre and library. Major repairs needed in medium term. Site has been marketed for disposal though may need to accommodate some of the existing uses on the redeveloped site.	391670	388580	Predominantly residential area	More than likely
H16	Stockport College Heaton Moor Campus, Buckingham Rd	Housing	Heaton Moor	80	2.33	College intends to sell the site following the redevelopment of Town Centre campus. The site is within a predominantly residential area and is regarded as suitable for housing development.	387895	392455	Predominantly residential area	More than likely
H25	MAN Diesel & Turbo UK Ltd, Mirlees Drive	Housing	Hazel Grove	203	6	Demolition of existing buildings, mixed employment and residential development comprising B2/B8 move-on units and up to 203 dwellings (183 houses and 20 flats).	390736	387062	Application not yet decided	More than likely
H26	Former Cherry Tree Hospital, Cherry Tree Ln	Housing	Great Moor	75	2.15	A nursery and vacant former hospital site identified as surplus to requirements by Stockport PCT.	391275	388390	Predominantly residential area	More than likely
R1	32 Woodford Road	Retail	Bramhall	553 A1, 202 A3	0.03	A former 533sq m gross Woolworths (A1 use) with 202 sq m upper floor offices; ground floor changed use to a restaurant (A3 use).	389,085	384268	DC043585 Grant 18/03/10 Site is complete	Complete
R2	91 Lower Hillgate	Retail	Stockport	63 gross 509 net A1	0.06	Change use of ground floor from a restaurant to office/showroom	389,797	390204	DC042719 Grant 20/10/09. Site is complete	Complete

Reference	Site	Type	Location	Floorspace (sqm) / Dwellings	Site Area	Description	Easting	Northing	Plan Status	Uncertainty by 2017
R3	Former Remploy Site, Broadstone Road	Retail	Heaton Chapel	2,286 gross D2 and 326 B1 office	0.4ha	Change use of existing building from B8 (Warehouse) to D2 (Leisure) and B1 (offices), external alterations and provision of parking facilities	389,125	393085	DC042878 Grant 20/07/10. Site is complete	Complete
R7	Town Centre, Unit 3 Peel Centre	Retail	Great Portwood Street	936 gross A1	0.094ha	Installation of mezzanine floor	389,945	390839	DC040039 Grant 21/01/10.	More than likely
R10	Offerton Shopping Precinct	Retail	Offerton	1,603 gross; 1,239 A1, 210 A3	0.652ha	Demolition of existing buildings and regeneration of the site to provide a neighbourhood food store, retail unit, pharmacy and restaurant	391932	388887	DC044143 Grant 17/01/11.	More than likely
R13	Town Centre Hollands Mill Site	Retail	61A-63 Shaw Heath	500 gross	0.84ha	A1, A2, A3, A4 or A5 use	389494	389364	DC041892 Grant 20/04/10.	More than likely
R14	Micro Direct, Weybrook Road	Retail	Heaton Chapel	1,448 gross, 990 net	0.69ha	Demolition of warehouse and erection of a food store with associated access car parking and landscaping	387,968	393074	DC046007 Grant 23/05/11.	Near certain
R15	Lancashire Hill, Halfords Unit, Manchester Road Retail Park	Retail	Manchester Road, Stockport	1,773 gross, 1,418 net	0.896ha	Reconfiguration and extension of existing retail unit and improvements to the car parking layout, internal access road and service vehicle access point	383374	391520	DC029295 Grant 11/06/08. Under construction	Near certain
R18	Lancashire Hill, Manchester Road Retail Park	Retail	Stockport		3.172ha	External alterations to elevations and reconfiguration of existing floorspace to create eight new retail units (class A1) and improvements to the layout of the car park and service vehicle access	389402	391491	DC041835 Grant 17/12/09.	More than likely
R19	Town Centre J Sainsbury's	Retail	Stockport	14,629 gross external area. Including 6,551 net sales area	3.79ha	Relocation and expansion of J Sainsbury's. Proposes 6551sq m net A1 use floorspace supermarket at Knightsbridge and closure of existing 2,599sq m net Sainsburys supermarket at Warren Street which would then be likely to be redeveloped/occupied by a comparison goods retailer	389841	390826	DC047669 Application not yet decided	Near certain

2017 Core Scenario Trafford

Reference	Site	Type	Site Status	Floorspace (sqm) / Dwellings	Easting	Northing	Uncertainty by 2017
10049	Stamford Centre	Employment/Retail	Expired	1,660	376902	387995	Near Certain
10133	Altair Site	Employment/Retail	Outline Planning Permission	8,471	377052	387978	Near Certain
10055	Jarvis House	Employment/Retail	Resolution To Approve	735	3762090	3891500	Near Certain
32133	Partington Wharfside	Employment/Retail	Under Construction	24,047	3722200	3921170	Near Certain
60030	Trafford Town Hall	Employment/Retail	Resolution To Approve	11,019	381009	395844	Near Certain
CS E1	Pomona Island	Employment/Retail			381980	396865	More than likely
CS E3	Trafford Park Core	Employment/Retail			378500	396500	More than likely
CS E4	Trafford Centre Rectangle	Employment/Retail			376930	396644	More than likely
CS E5	Carrington	Employment/Retail			374500	392500	More than likely
1177	Stamford brook,sinderland brook (part hou4)	Housing	Reserved matters	90	375851	389924	Near Certain
1193	Stamford brook - phase 2/3,sinderland brook (part) hou4)	Housing	Reserved matters pp	380	375783	390179	Near Certain
1468	Land at ripon crescent,brompton road	Housing	Full planning permission	80	377865	395193	Near Certain
CS H1	Pomona island	Housing		800	381729	396646	More than likely
CS H2	Trafford wharfside	Housing		900	380483	396817	More than likely
CS H3	Lccc	Housing	None	400	380928	395685	More than likely
CS H4	Trafford centre rectangle	Housing	None	1,050	376205	397260	More than likely
CS H5	Carrington	Housing		1,560	373184	392392	More than likely

2032 Core Scenario Cheshire East Council

Reference	Site	Type	Location	Floorspace (sqm) / Dwellings	Description	Easting	Northing	Uncertainty by 2032
2	Tytherington Business Park remaining plots on phases 1 & 2	Employment	Springwood Way, Macclesfield	Circa 28,000 B1a remaining	Large greenfield site allocated in Local Plan. High quality business park principally for B1 uses.	392261	375965	Near certain
3	Tytherington Business Park Phase 3	Retail	Springwood Way / Manchester Road, Macclesfield	25,618 office plus 100 bed hotel	Greenfield allocated site. Planning consent principally for B1 uses with an element of C1.	391827	376019	Near certain
4	Land off Albert Road	Employment	Albert Road, Bollington	6,782 industrial units	Greenfield allocated sites	392128	377795	Near certain
6	Wilmslow Office Park	Employment	Stamford Lodge, Altrincham Road, Wilmslow	Circa 22,000 office space	Cleared redevelopment site in the Green Belt.	383038	382475	Near certain
7	Land to rear of Handforth Dean Retail Park	Employment	Lower Meadow Road, Handforth	Potential circa 20,000 office space	Greenfield site	386222	383623	Near certain
8	Handforth Dean Business Park	Employment	Epsom Avenue, Handforth	13,740 office space	Two sites in existing industrial estate	386316	383985	Near certain
9	Parkgate Industrial Estate extension	Employment	Haig Road / Mobberley Road, Knutsford	Potential circa 30,000 industrial and office	Allocated for B1/B2/B8 but constrained by access. New access from Mobberley Road now in place but requires a tunnel under railway to connect the site	376677	379763	Near certain
10	Additional expansion land at Parkgate Industrial Estate	Employment	Haig Road / Mobberley Road, Knutsford	32,762 industrial and office	Additional allocation for B1/B2/B8 to help overcome viability issues associated with cost of new access to Parkgate extension	376462	379945	More than likely
11	Macclesfield Town Centre Redevelopment	Employment	Macclesfield	Estimated net gains: Circa 25,000 A1 /A2 uses (predominantly A1); 3000 A3/A4/A5; 2000 B1a; 8 screen cinema plus 100 dwellings	Large town centre redevelopment scheme. Revised scheme likely to differ from existing application - masterplanning exercise will review development. Floorspace figures have been estimated accordingly	391693	373351	More than likely
13	Knutsford Supermarket	Retail	Brook Street, Knutsford	1,560 food retail	Edge of centre redevelopment site	375500	378483	Near certain
14	Macclesfield District General Hospital Blue Zone	Housing	Cumberland Street, Macclesfield	67 dwellings, 75-bed care home, 550 sqm retail and 3,600 sqm office block	Surplus hospital land	390977	373935	Near certain
19	Henbury High School Site	Housing	Whirley Road, Macclesfield	123	Former school site	389080	373747	Near certain
22	Cheshire Mills	Housing	Disley	160	Underused industrial site	398270	384846	Near certain
23	Vernon County Infant School	Housing	Bulkely Road, Poynton	73	Former school site	392163	383385	Near certain
24	Ingersley Vale	Housing	Bollington	66	Underused industrial site	394231	377362	Near certain
26	Land near former Old Kings Head PH	Employment	Chestergate, Macclesfield	576 A1	Brownfield town centre site	391525	373809	Near certain
27	Unit 8	Retail	Lyme Green Retail Park, Macclesfield	3,179 gross, 1,683 net A1	Brownfield out of centre retail park unit	391509	371165	Near certain
28	Curry's Ltd	Retail	Lyme Green Retail Park, Macclesfield	560 A1	Brownfield out of centre retail park unit	391409	371133	Near certain
29	Unit 6	Retail	Lyme Green Retail Park, Macclesfield	1,352 gross, 720 net A1	Brownfield out of centre retail park unit	391448	371120	Near certain

Reference	Site	Type	Location	Floorspace (sqm) / Dwellings	Description	Easting	Northing	Uncertainty by 2032
30	AstraZeneca	Employment	Alderley House, Alderley Edge	6,256 gross	Erection of research building	384737	375562	Near certain
31	IFE Services Ltd	Employment	Haig Road / Mobberley Road, Knutsford	2,380 gross / 1,180 net	Demolition of existing buildings and erection of two new office buildings	376150	379507	Near certain
32	Land at Mottram Way	Employment	Macclesfield	1,903 gross / 654 net	Erection of two new buildings (phase 3) comprising six single storey units	392086	374855	Near certain
33	Rupert House	Employment	London Road South, Poynton	2,522	Erection of two storey office building (b1) and five industrial storage and distribution units (b2/b8) with associated parking and turning areas.	391660	382521	Near certain
34	22-24 Manchester Road	Employment	Wilmslow	1,005 gross / 732 net	Demolition of existing buildings and erection of three-storey office building incorporating car parking and alterations to access	384897	381293	Near certain
35	Wycliffe House	Employment	Water Lane, Wilmslow	1,520	Erection of three storey extension for b1 office purposes and provision of additional decked car parking accommodation	384410	380995	Near certain

2032 Core Scenario High Peak

Reference	Site	Type	Location	Floorspace (sqm) / Dwellings	Description	Easting	Northing	Uncertainty by 2032
H1	Granby Road	Housing	Buxton	104		407280	373200	Near certain
H2	Dale Lane	Housing	Buxton	221	Site requires development of Fairfield Link Road which is likely to delay the scheme	407290	373960	Near certain
H4	Former college site, Harpur Hill	Housing	Buxton	105		406720	370969	Near certain
H6	Charlestown Works	Housing	Glossop	100	SHLAA site on industrial land	403360	393010	Near certain
H7	Forge Works	Housing	Chinley	200	SHLAA site on industrial land	404385	382136	Near certain
H8	Federal Mogul	Housing	Chapel-en-le-Frith	200	Potential mixed-use scheme with housing	405860	381180	Near certain
E1	Morrisons extension	Employment/Retail	Buxton	1,253	Extension to existing supermarket	406575	372959	Near certain
E4	Tesco	Employment/Retail	Whaley Bridge	1,249	Extension to existing supermarket	401291	382103	Near certain
E5	Howard Town Mill	Employment/Retail	Glossop	Supermarket – 1,921 Mixed A1 non-food, A3 and A4 – 2,517	Mixed-use scheme including A1 (food and non-food), A3 and A4.	403545	393983	Near certain
E6	Staden Lane	Employment/Retail	Buxton	B8 – 1,168	Proposed chill store extension, pallet storage, office, canteen & staff facilities	407026	371986	Near certain
E7	Dinting Lodge	Employment/Retail	Glossop	B2 – 12,160	Extension to the NE corner of the main industrial building	401746	394826	Near certain
E8	Waterswallows Road	Employment/Retail	Buxton	B2 – 23,865	Construction of bottling plant and warehousing	407970	375375	Near certain
E9	Waterswallows Road	Employment/Retail	Buxton	3,717	mixed use general industrial, storage and distribution	408090	375070	Near certain
E10	Bowden Lane	Employment/Retail	Chapel-en-le-Frith	5,700	Industrial units	406341	381281	Near certain

2032 Core Scenario Manchester City

Reference	Site	Type	Floorspace (sqm) / Dwellings	Comments/Location	Easting	Northing	Uncertainty by 2032
H1	Sites at former Withington Hospital, West Didsbury	Housing	299	Housing sites under construction plus additional land identified as suitable. Total capacity around 299 units	381767	394489	Near Certain
H2	Former City College Site, Moor Road, Brooklands	Housing	50	Housing site under construction. Approx 50 units still to be completed	380633	389778	Near Certain
H3	Styal Road, Woodhouse Park	Housing	14 house, 135 apartments	Housing site partially complete. 147 units in total.	384201	385752	Near Certain
H4	Wastdale Road, Baguley	Housing	67	Housing site with expired permission, some works carried out in site preparation. Revised application submitted but withdrawn. Suitable for 50-70 units.	381059	387846	Near Certain
H5	Portway/Petheridge Drive, Woodhouse Park	Housing	88	Housing site under construction. 88 units.	381721	386363	Near Certain
H6	Former school site at Darley Avenue, Chorlton Park	Housing	86	Land identified in SHLAA as suitable for housing provision. Could provide 86 units.	381148	393899	Near Certain
H7	MMU Campus Didsbury East	Housing	188	Land identified in SHLAA as suitable for housing provision. Could provide 188 units. MMU aim to consolidate on a site in Hulme	384841	390563	Near Certain
H8	Tuffley Road, Rodborough Road	Housing	68	Planning Permission for 68 units	381024	387353	Near Certain
H9	East of Rowlandsway, Sharton	Housing	90	Land identified in SHLAA as suitable for housing provision as part of a reconfiguration/ redevelopment of areas within Wythenshawe Town Centre. Could provide 90 units	382867	386916	Near Certain
H10	Tuffley Road, Rodborough Road	Housing	68	Planning Permission for 68 units	381024	387353	Near Certain
E1	Expansion of Manchester Airport from approximately 20 million passengers per annum to 45 million passengers per annum by 2030. Increasing the operational area from 625ha to 800ha	Employment/Retail	175 ha	Existing Airport Operation Area identified in the City of Manchester UDP	381233	386333	Near Certain
E2	Expansion of Manchester Airport from approximately 20 million passengers per annum to 45 million passengers per annum by 2030. Increasing the operational area from 625ha to 800ha	Employment/Retail			383989	385022	Near Certain
E3	Expansion of Manchester Airport from approximately 20 million passengers per annum to 45 million passengers per annum by 2030. Increasing the operational area from 625ha to 800ha	Employment/Retail	B1- 20,000, B8 - 32,000 & B2, C1	Proposed Airport Operation Area identified as a draft Strategic Site in the Core Strategy.	380428	384538	Near Certain

Reference	Site	Type	Floorspace (sqm) / Dwellings	Comments/Location	Easting	Northing	Uncertainty by 2032
E4	Airport City approximately 30ha (predominantly proposed for B1 business and office use including advanced manufacturing, with complementary uses including, hotel, leisure, conferencing and possibly residential) at Manchester Business Park	Employment/Retail	15,000 sqm / 30 ha	Planning Permission for 15,000sqm of office development	380548	385200	100% Near Certain
E5	Airport City approximately 30ha (predominantly proposed for B1 business and office use including advanced manufacturing, with complementary uses including, hotel, leisure, conferencing and possibly residential) at Manchester Business Park	Employment/Retail	B1 - 73,000, B2, B8, A1, C1, C3	Manchester Business Park allocated in the City of Manchester UDP for High Technology Industries	381779	385654	100% Near Certain
E6	Airport City approximately 30ha (predominantly proposed for B1 business and office use including advanced manufacturing, with complementary uses including, hotel, leisure, conferencing and possibly residential) at Manchester Business Park	Employment/Retail		To be identified as part of a strategic location in the Core Strategy	383379	385010	100% Near Certain
E7	Health Zone (development of core hospital uses such as patient wards and hospital theatres, and core plus uses such as research and education) at Wythenshawe Hospital	Employment/Retail	D1, C1, C2	To be identified as part of a strategic location in the Core Strategy	380400	387500	Near Certain
E8	New District Centre Baguley	Employment/Retail	A1, A2, A3, B1, C1,C2,C3	Identified in the draft Core Strategy	380288	389394	Near Certain
E9	New Town Centre Bus Station at Wythenshawe Hospital	Employment/Retail	0.54 ha	Submitted Planning application and funding in place	382770	387124	Near Certain
E11	3,120sqm of office planning permission on 0.39ha at Cedars, Wythenshawe	Employment/Retail	3,120 / 0.39 ha	Under construction for B1 offices.	382838	387328	Near Certain
E13	20,169sqm on 3.04ha site at Didsbury Point, Princess Road	Employment/Retail	20,169 / 3.04 ha	Planning permission for B1	383463	392501	Near certain
E15	Etrop Court 2 shops, 6206sqm on 0.94ha office B1 (District offices for the Local authority) at Rowlandsway, Wythenshawe	Employment/Retail	6,206 / 0.94 ha	Planning permission for B1	382713	387187	Near Certain
E16	Private Hospital @ Didsbusry Point	Employment/Retail	15,500	Planning permission	383580	392651	Near Certain
E17	New Bus Garage, Stage Coach @ Longley Lane	Employment/Retail	4,385 / 1.75 ha	Planning Permission	383405	389049	Near Certain
E18	Recycling Centre rebuild@ Longley Lane	Employment/Retail	7,064		383662	389062	Near Certain

2032 Core Scenario Stockport

Reference	Site	Type	Location	Floorspace (sqm) / Dwellings e	Site Area	Description	Easting	Northing	Plan Status	Uncertainty by 2032
E1	Cheadle Royal	Employment	Cheadle Royal Business Park, Cheadle	11,000 B1 office	2.84Ha	Major office development site with a number of consents and outline permission. Figure includes all land still available for development, with estimated floorspace	385340	385945	Allocation in Employment Area, with some full permissions to be implemented	Near certain
E2	Green Lane Industrial Area	Employment	Higher Bury Street, Stockport	574 B1 office	0.6Ha	Office development at vacant site	388661	390666	Full permission in employment area	Near certain
E3	Cheadle District Centre	Employment	Travis Perkins, Lime Grove, Cheadle	1,011 B8	0.51Ha	Redevelopment of existing site	385,699	388732	Employment site adjacent to district centre	Near certain
E4	Former Thomas Storey Site	Employment	Tiviot Way, Stockport	19,888 B2/B8	6.6Ha	Development of a number of B2 and B8 units vacant employment site	389000	391000	Permission granted	Near certain
E5	Land at Pepper Road	Employment	Pepper Road, Hazel Grove	500 light industrial	1.01Ha	Development of light industrial unit	391020	386720	Full permission in Employment Area	More than likely
E6	Lawnhurst Business Park	Employment	Thales, Ashurst Drive, Cheadle Heath	3,345 B1 office	0.87Ha	Office extension at existing use	387789	388191	Full permission in employment area	More than likely
E7	Kings Vallley	Employment	Yew Street, Stockport	12,555 B1 office	2.54Ha	Permission for a number of units in an allocated site close to M60 Jct.1	388139	390049	Full permission in employment area	Near certain
E9	Battersea Road Business Park	Employment	Battersea Road, Heaton Mersey	4,479 B1 office	1.24Ha	Office development at vacant site	386550	390079	Full permission in employment area	Near certain
E11	Stockport Town Centre	Employment	Town Centre Area	65,000 B1 office		Major focus for future office development in borough over a number of sites in the town centre. Estimated floorspace. (Easting/Northing given is for one particular site in the town centre).	389590	390250	Sites to be allocated through LDF process, however such development in the town centre is likely to be acceptable in policy.	More than likely
E12	Bredbury Parkway	Employment		22,500 B2/B8	7Ha	A number of different sites in this large employment area have potential for (re)development. This is an estimated total area and floorspace for what will primarily be B2 and B8 uses. (Easting/Northing given is for one particular site in the employment area).	392575	392512	Variety of vacant sites and permissions within and permissions	More than likely
E13	Woodford	Housing	Former BAE site	950	25 Ha	The Woodford Aerodrome Opportunity Site SPD (January 2013) identifies a residential development	390800	382700	Vacant site within an approved SPD	More than likely

Reference	Site	Type	Location	Floorspace (sqm) / Dwellings e	Site Area	Description	Easting	Northing	Plan Status	Uncertainty by 2032
H1	Site of New Mill, Houldsworth Street	Housing	Reddish	291	2.77	Conversion and extension to existing mills to provide 383 units and 88 units in new 6 storey block - 471 in total. Phase I complete (180 flats) - hence no. of units given is 291. Phase II (123) started but has stalled. Phases III and IV may be scaled back.	389119	393678	Under construction	Near certain
H2	104, 106 Cross Lane and Park and Paterson Ltd	Housing	Marple	79	1.93	Application granted Oct 2010 for demolition of vacant foundry and ancillary buildings and redevelopment of site for 79 dwellings.	395025	388354	Under construction	Near certain
H3	Goyt Works, Station Road	Housing	Strines	96	2.5	Redevelopment to provide 96 houses and 2 employment units.	397410	386519	Under construction	Near certain
H4	Site A - Phase 2 (Former Bridgehall Sidings)	Housing	Bridgehall	150	4.9	Allocated housing site reclaimed using derelict land grant. New road access created and the site is now ready for redevelopment after being regraded and levelled.	388339	388720	Allocated housing site	Near certain
H5	Land at Midland Rd / Geneva Rd	Housing	Bramhall	163	5	Development of landfill site - 163 managed flats comprising one 3/4 storey and four 3 storey blocks of flats (139 x 2 bed units - 30 AH) & one 3 storey block of 24 sheltered flats for elderly persons (15 x 2 bed and 9 x 1 bed).	388982	387378	Application not yet decided	Near certain
H6	Former Barnes Hospital, Kingsway	Housing	Cheadle	128	3.8	Conversion of vacant hospital buildings to create 42 flats and erection of 18 town houses and 68 flats.	385216	389011	Full planning permission	Near certain
H7	Compstall Mills, Andrew Street	Housing	Compstall	121	1.55	The Planning Brief for this Major Existing Developed Site in the Green Belt lists housing as an acceptable use. Application submitted 22/6/09 for mixed use development including 121 residential units.	396550	390760	Application not yet decided	Near certain
H8	Hollands Mill site, 61a - 63 Shaw Heath	Housing	Town Centre	112	0.752	Outline application granted 20/04/2010 for mixed-use development of vacant site providing up to 112 residential units.	389515	389410	Outline planning permission	Near certain
H9	Hopes Carr Phase 1	Housing	Town Centre	90	1.2	Planning permission granted Mar 2010 for a total of 90 units and 2 retail units in line with approved masterplan for wider Covent Garden area.	389950	390240	Full planning permission	Near certain

Reference	Site	Type	Location	Floorspace (sqm) / Dwellings e	Site Area	Description	Easting	Northing	Plan Status	Uncertainty by 2032
H12	Dialstone Centre, Lisburne Lane	Housing	Offerton	90	3.5	Former secondary school converted to Council offices, training centre, leisure centre and library. Major repairs needed in medium term. Site has been marketed for disposal though may need to accommodate some of the existing uses on the redeveloped site.	391670	388580	Predominantly residential area	Near certain
H13	Hopes Carr Phase 2 / Covent Garden sites	Housing	Town Centre	120	2.64	Masterplan for wider Covent Garden area approved Dec 09 with indicative total of 270 additional units including development of this car park / vacant site and refurbishment of existing flats. See also site 247 in particular.	389900	390170	Town Centre area	More than likely
H15	Oakwood Mills, Oakwood Road	Housing	Romiley	150	4.3	Site put forward during SHLAA Call for Sites exercise. Used scheme submitted during UDP review to estimate capacity. 90 houses and 60 flats in 4 three storey blocks (5 flats on each floor).	394460	390525	Predominantly residential area	More than likely
H16	Stockport College Heaton Moor Campus, Buckingham Rd	Housing	Heaton Moor	80	2.33	College intends to sell the site following the redevelopment of Town Centre campus. The site is within a predominantly residential area and is regarded as suitable for housing development.	387895	392455	Predominantly residential area	Near certain
H24	Bus depot and adjacent works buildings, Charles St	Housing	Heaviley	75	1.87	Bus depot in use. Adjoining warehouse largely vacant. Unlikely that works/warehouse part of site will be development without bus depot. More likely and desirable if comprehensive development takes place but then has to be regarded as a long term site.	390270	389315	Mixed Use Policy Guidance Area	More than likely
H25	MAN Diesel & Turbo UK Ltd, Mirlees Drive	Housing	Hazel Grove	203	6	Demolition of existing buildings, mixed employment and residential development comprising B2/B8 move-on units and up to 203 dwellings (183 houses and 20 flats).	390736	387062	Application not yet decided	Near certain
H26	Former Cherry Tree Hospital, Cherry Tree Ln	Housing	Great Moor	75	2.15	A nursery and vacant former hospital site identified as surplus to requirements by Stockport PCT.	391275	388390	Predominantly residential area	Near certain

Reference	Site	Type	Location	Floorspace (sqm) / Dwellings e	Site Area	Description	Easting	Northing	Plan Status	Uncertainty by 2032
H27	Offerton High School, The Fairway	Housing	Offerton	75	2.5	The school is due to close in August 2012. It is a Major Existing Developed Site (MEDS) in the Green Belt, attached to the urban area, and occupies a prominent position adjoining the Goyt Valley. Redevelopment of the site is to be in accordance with a brief agreed by the Council.	392070	389440	MEDS	More than likely
R1	32 Woodford Road	Retail	Bramhall	553 A1, 202 A3	0.03	A former 533sq m gross Woolworths (A1 use) with 202 sq m upper floor offices; ground floor changed use to a restaurant (A3 use).	389,085	384268	DC043585 Grant 18/03/10 Site is complete	Complete
R2	91 Lower Hillgate	Retail	Stockport	636sqm gross 509sqm net A1 use	0.06	Change use of ground floor from a restaurant to office/showroom	389,797	390204	DC042719 Grant 20/10/09. Site is complete	Complete
R3	Former Remploy Site, Broadstone Road	Retail	Heaton Chapel	2,286 gross D2 and 326 B1 office	0.4ha	Change use of existing building from B8 (Warehouse) to D2 (Leisure) and B1 (offices), external alterations and provision of parking facilities	389,125	393085	DC042878 Grant 20/07/10. Site is complete	Complete
R4	Town Centre, Former Greenhale House	Retail	Piccadilly SK1 3DY	6,882	0.179ha	New mixed use hotel development inc. Conference facilities, leisure suite and associated parking	389575	390089	DC043685 Grant 19/08/10	More than likely
R5	Town Centre, Former Greenhale House	Retail	Piccadilly SK1 3DY	664	0.172ha	Mixed use development comprising 155 residential units and 2 commercial units	389575	390089	DC025628 Grant 25/01/08	More than likely
R7	Town Centre, Unit 3 Peel Centre	Retail	Great Portwood Street	936 gross A1	0.094ha	Installation of mezzanine floor	389,945	390839	DC040039 Grant 21/01/10.	Near certain
R9	Town Centre, Rock Buildings, Mersey Square	Retail	Stockport	2,254	0.14ha	Conversion of the Rock Buildings and demolition and new build of previous extensions/outbuildings to form an 81 bedroom hotel	389,351	390333	DC040486 Grant Full Planning Permission 04/06/09.	More than likely
R10	Offerton Shopping Precinct	Retail	Offerton	1,603 gross; 1,239 A1, 210 A3	0.652ha	Demolition of existing buildings and regeneration of the site to provide a neighbourhood food store, retail unit, pharmacy and restaurant	391932	388887	DC044143 Grant 17/01/11.	Near certain
R11	M60 Gateway	Retail	Land at Water Street	5574 gross	1.1ha	Two storey class A1 non-food retail/class D2 leisure development, with associated parking and ancillary facilities	389,890	391078	DC043981 Grant 29/07/10.	More than likely
R12	M60 Gateway	Retail	Land at Water Street	2860 A1 and 3150 hotel	1.2ha	Mixed use (non-food retail and hotel)	389,890	391078	DC044091 Grant 06/01/11.	More than likely
R13	Town Centre Hollands Mill Site	Retail	61A-63 Shaw Heath	500 gross	0.84ha	A1, A2, A3, A4 or A5 use	389494	389364	DC041892 Grant 20/04/10.	Near Certain

Reference	Site	Type	Location	Floorspace (sqm) / Dwellings e	Site Area	Description	Easting	Northing	Plan Status	Uncertainty by 2032
R14	Micro Direct, Weybrook Road	Retail	Heaton Chapel	1,448 gross, 990 net	0.69ha	Demolition of warehouse and erection of a food store with associated access car parking and landscaping	387,968	393074	DC046007 Grant 23/05/11.	Near certain
R15	Lancashire Hill, Halfords Unit, Manchester Road Retail Park	Retail	Manchester Road, Stockport	1,773 gross, 1,418 net	0.896ha	Reconfiguration and extension of existing retail unit and improvements to the car parking layout, internal access road and service vehicle access point	383374	391520	DC029295 Grant 11/06/08. Under construction	Near certain
R18	Lancashire Hill, Manchester Road Retail Park	Retail	Stockport		3.172ha	External alterations to elevations and reconfiguration of existing floorspace to create eight new retail units (class A1) and improvements to the layout of the car park and service vehicle access	389402	391491	DC041835 Grant 17/12/09.	More than likely
R19	Town Centre J Sainsbury's	Retail	Stockport	14,629 gross external area. Including 6,551 net sales area	3.79ha	Relocation and expansion of J Sainsbury's. Proposes 6551sq m net A1 use floorspace supermarket at Knightsbridge and closure of existing 2,599sq m net Sainsburys supermarket at Warren Street which would then be likely to be redeveloped/occupied by a comparison goods retailer	389841	390826	DC047669 Application not yet decided	Near Certain

2032 Core Scenario Trafford

Reference	Site	Type	Floorspace (sqm) / Dwellings	Site Status	Easting	Northing	Uncertainty by 2032
10049	Stamford Centre	Employment/Retail	1,660	Expired	376902	387995	Near Certain
10133	Altair Site	Employment/Retail	8,471	Outline Planning Permission	377052	387978	Near Certain
10055	Jarvis House	Employment/Retail	735	Resolution To Approve	3762090	3891500	Near Certain
32133	Partington Wharfside	Employment/Retail	24,047	Under Construction	3722200	3921170	Near Certain
60030	Trafford Town Hall	Employment/Retail	11,019	Resolution To Approve	381009	395844	Near Certain
CS E1	Pomona Island	Employment/Retail			381980	396865	Near Certain
CS E3	Trafford Park Core	Employment/Retail			378500	396500	Near Certain
CS E4	Trafford Centre Rectangle	Employment/Retail			376930	396644	Near Certain
CS E5	Carrington	Employment/Retail			374500	392500	Near Certain
1177	Stamford brook,sinderland brook (part hou4)	Housing	90	Reserved matters	375851	389924	Near Certain
1193	Stamford brook - phase 2/3,sinderland brook (part hou4)	Housing	380	Reserved matters pp	375783	390179	Near Certain
1468	Land at ripon crescent,brompton road	Housing	80	Full planning permission	377865	395193	Near Certain
CS H1	Pomona island	Housing	800		381729	396646	Near Certain
CS H2	Trafford wharfside	Housing	900		380483	396817	Near Certain
CS H3	Lccc	Housing	400	None	380928	395685	Near Certain
CS H4	Trafford centre rectangle	Housing	1,050	None	376205	397260	Near Certain
CS H5	Carrington	Housing	1,560		373184	392392	Near Certain

Appendix F

Scheme Junction Model Output

Appendix F.1

A6MARR/ Realigned A6 LinSig Output

A6MARR/ Realigned A6 LinSig Output

Full Input Data And Results

User and Project Details

Project:	A6MARR
Title:	A6MARR / A6
Location:	
File name:	1 - A6MARR_BuxtonRd_Free-Flow_Left.lsg3x
Author:	PM
Company:	Atkins
Address:	Bank Chambers, Faulkner Street, Manchester
Notes:	

Network Layout Diagram

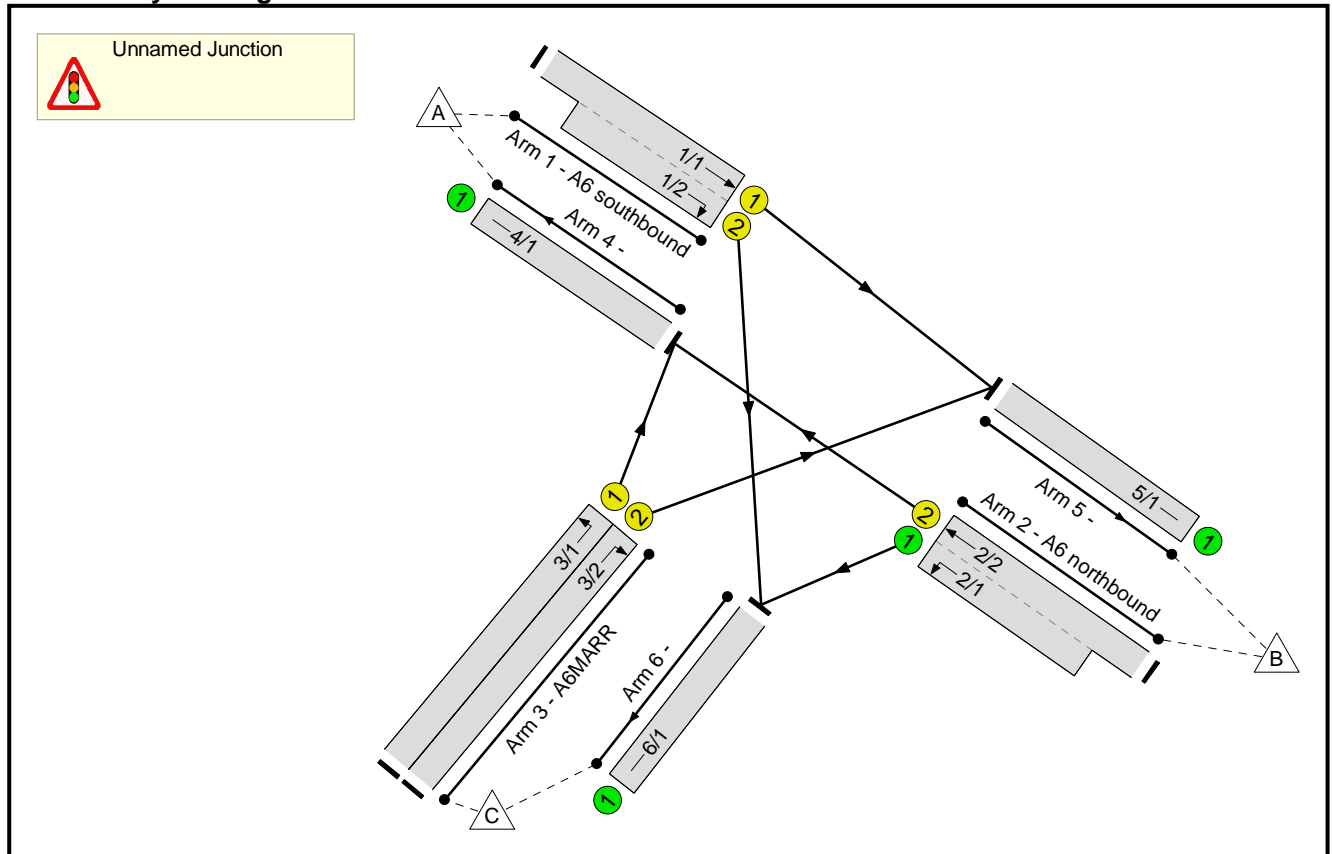

Phase Diagram

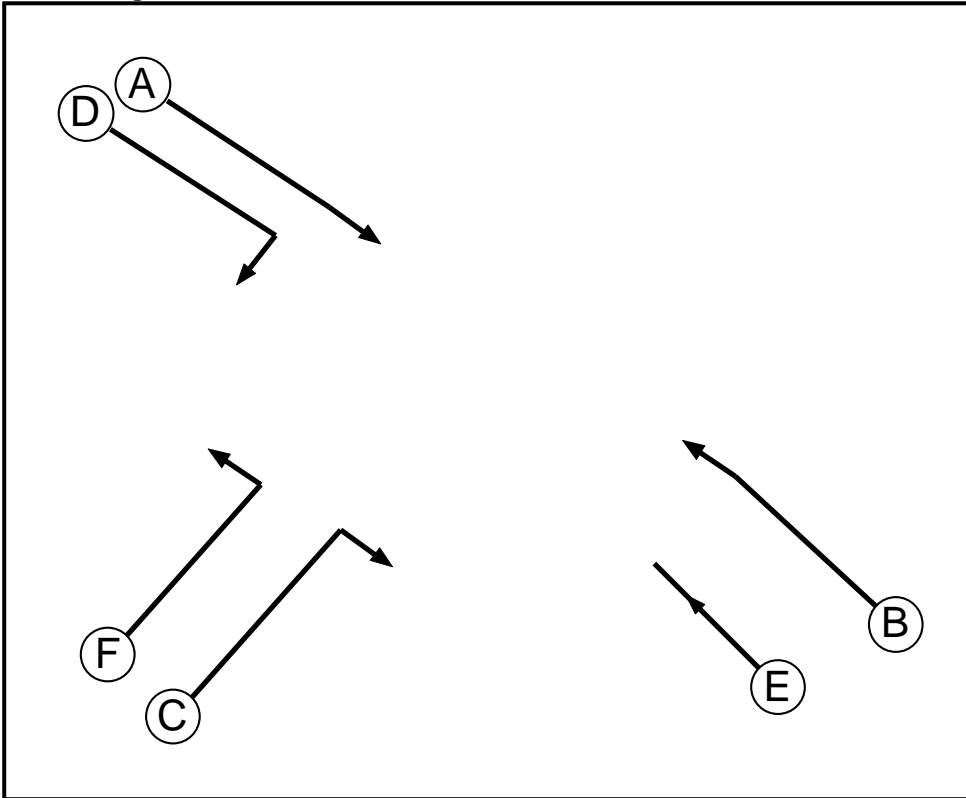

Phase Input Data

Phase Name	Phase Type	Stage Stream	Assoc. Phase	Street Min	Cont Min
A	Traffic	1		-9999	7
B	Traffic	1		-9999	7
C	Traffic	1		-9999	7
D	Traffic	1		-9999	7
E	Traffic	1		-9999	7
F	Traffic	1		-9999	7

Phase Intergreens Matrix

		Starting Phase					
		A	B	C	D	E	F
Terminating Phase	A	-	5	-	-	-	-
	B	-	6	5	-	8	-
	C	5	5	5	-	-	-
	D	-	5	6	8	-	-
	E	-	-	-	5	-	-
	F	-	5	-	-	-	-

Phases in Stage

Stream	Stage No.	Phases in Stage
1	1	A B E
1	2	A D F
1	3	C E F

Stage Diagram

Stage Stream: 1

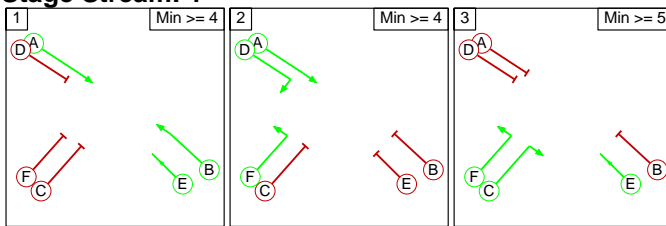

Phase Delays

Stage Stream: 1

Term. Stage	Start Stage	Phase	Type	Value	Cont value
1	3	A	Losing	1	1
2	3	A	Losing	1	1

Prohibited Stage Change

Stage Stream: 1

		To Stage		
		1	2	3
From Stage	1	-	8	8
	2	8	-	8
	3	5	5	-

Give-Way Lane Input Data

Junction: Unnamed Junction
There are no Opposed Lanes in this Junction

Lane Input Data

Junction: Unnamed Junction												
Lane	Lane Type	Phases	Start Disp.	End Disp.	Physical Length (PCU)	Sat Flow Type	Def User Saturation Flow (PCU/Hr)	Lane Width (m)	Gradient	Nearside Lane	Turns	Turning Radius (m)
1/1 (A6 southbound)	U	A	2	3	60.0	Geom	-	3.70	0.00	Y	Arm 5 Ahead	Inf
1/2 (A6 southbound)	U	D	2	3	30.4	Geom	-	3.70	0.00	N	Arm 6 Right	14.00
2/1 (A6 northbound)	U		2	3	28.7	User	2000	-	-	-	-	-
2/2 (A6 northbound)	U	B	2	3	60.0	Geom	-	4.20	0.00	Y	Arm 4 Ahead	Inf
3/1 (A6MARR)	U	F	2	3	60.0	Geom	-	4.00	0.00	Y	Arm 4 Left	15.00
3/2 (A6MARR)	U	C	2	3	60.0	Geom	-	4.60	0.00	N	Arm 5 Right	15.00
4/1	U		2	3	60.0	Inf	-	-	-	-	-	-
5/1	U		2	3	60.0	Inf	-	-	-	-	-	-
6/1	U		2	3	60.0	Inf	-	-	-	-	-	-

Traffic Flow Groups

Flow Group	Start Time	End Time	Duration	Formula
1: 'AM 2017'	08:00	09:00	01:00	
2: 'PM 2017'	16:00	17:00	01:00	

Scenario 1: 'AM 2017' (FG1: 'AM 2017', Plan 1: 'Network Control Plan 1')

Traffic Flows, Desired

Desired Flow :

		Destination			
		A	B	C	Tot.
Origin	A	0	418	49	467
	B	210	0	1068	1278
	C	110	959	0	1069
	Tot.	320	1377	1117	2814

Traffic Lane Flows

Lane	Scenario 1: AM 2017
Junction: Unnamed Junction	
1/1 (with short)	467(In) 418(Out)
1/2 (short)	49
2/1 (short)	1068
2/2 (with short)	1278(In) 210(Out)
3/1	110
3/2	959
4/1	320
5/1	1377
6/1	1117

Lane Saturation Flows

Junction: Unnamed Junction								
Lane	Lane Width (m)	Gradient	Nearside Lane	Allowed Turns	Turning Radius (m)	Turning Prop.	Sat Flow (PCU/Hr)	Flared Sat Flow (PCU/Hr)
1/1 (A6 southbound)	3.70	0.00	Y	Arm 5 Ahead	Inf	100.0 %	1985	1985
1/2 (A6 southbound)	3.70	0.00	N	Arm 6 Right	14.00	100.0 %	1919	1919
2/1 (A6 northbound Lane 1)	This lane uses a directly entered Saturation Flow						2000	2000
2/2 (A6 northbound)	4.20	0.00	Y	Arm 4 Ahead	Inf	100.0 %	2035	2035
3/1 (A6MARR)	4.00	0.00	Y	Arm 4 Left	15.00	100.0 %	1832	1832
3/2 (A6MARR)	4.60	0.00	N	Arm 5 Right	15.00	100.0 %	2014	2014
4/1	Infinite Saturation Flow						Inf	Inf
5/1	Infinite Saturation Flow						Inf	Inf
6/1	Infinite Saturation Flow						Inf	Inf

Scenario 2: 'PM 2017' (FG2: 'PM 2017', Plan 1: 'Network Control Plan 1')

Traffic Flows, Desired

Desired Flow :

	Destination				
		A	B	C	Tot.
Origin	A	0	549	27	576
	B	228	0	847	1075
	C	124	1066	0	1190
	Tot.	352	1615	874	2841

Traffic Lane Flows

Lane	Scenario 2: PM 2017
Junction: Unnamed Junction	
1/1 (with short)	576(In) 549(Out)
1/2 (short)	27
2/1 (short)	847
2/2 (with short)	1075(In) 228(Out)
3/1	124
3/2	1066
4/1	352
5/1	1615
6/1	874

Lane Saturation Flows

Junction: Unnamed Junction								
Lane	Lane Width (m)	Gradient	Nearside Lane	Allowed Turns	Turning Radius (m)	Turning Prop.	Sat Flow (PCU/Hr)	Flared Sat Flow (PCU/Hr)
1/1 (A6 southbound)	3.70	0.00	Y	Arm 5 Ahead	Inf	100.0 %	1985	1985
1/2 (A6 southbound)	3.70	0.00	N	Arm 6 Right	14.00	100.0 %	1919	1919
2/1 (A6 northbound Lane 1)	This lane uses a directly entered Saturation Flow						2000	2000
2/2 (A6 northbound)	4.20	0.00	Y	Arm 4 Ahead	Inf	100.0 %	2035	2035
3/1 (A6MARR)	4.00	0.00	Y	Arm 4 Left	15.00	100.0 %	1832	1832
3/2 (A6MARR)	4.60	0.00	N	Arm 5 Right	15.00	100.0 %	2014	2014
4/1	Infinite Saturation Flow						Inf	Inf
5/1	Infinite Saturation Flow						Inf	Inf
6/1	Infinite Saturation Flow						Inf	Inf

Scenario 1: 'AM 2017' (FG1: 'AM 2017', Plan 1: 'Network Control Plan 1')

Stage Sequence Diagram

Stage Stream: 1

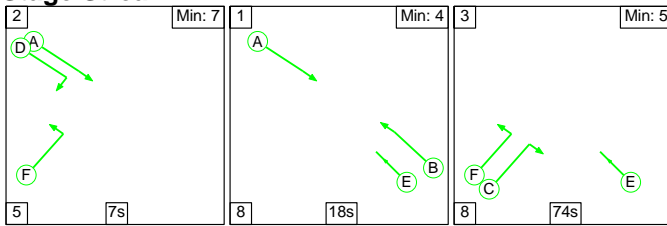

Stage Timings

Stage Stream: 1

Stage	2	1	3
Duration	7	18	74
Change Point	115	7	33

Signal Timings Diagram

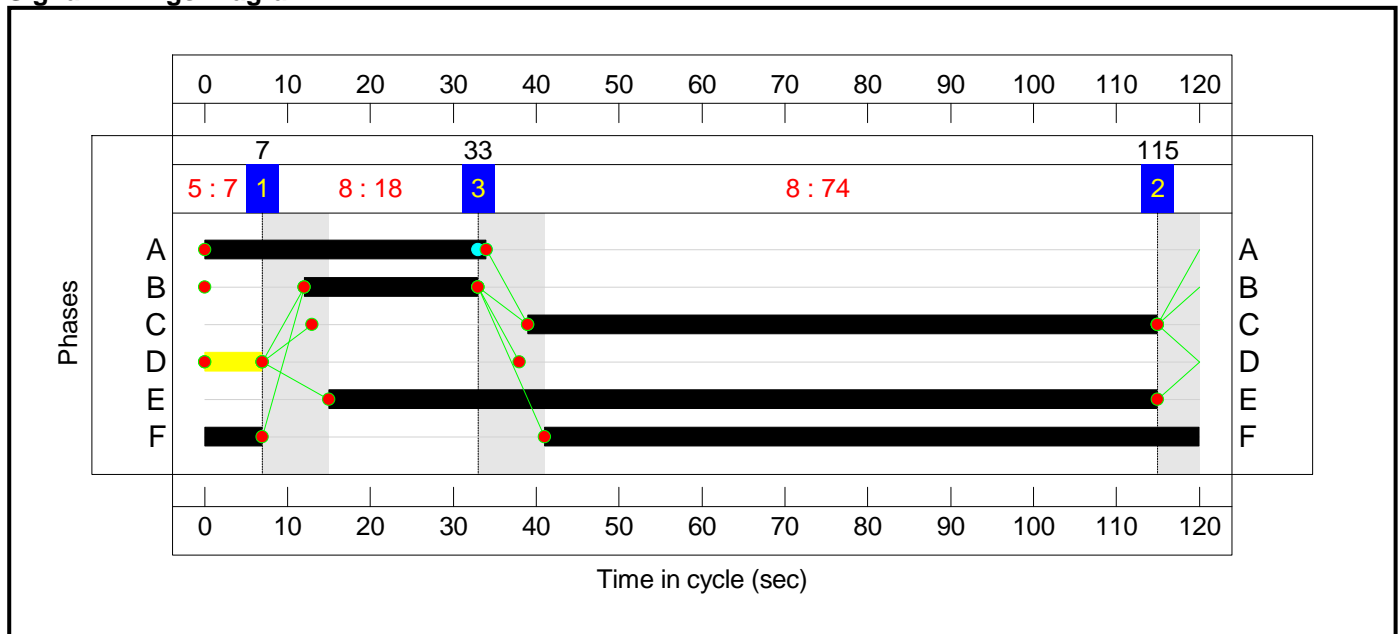

Network Layout Diagram

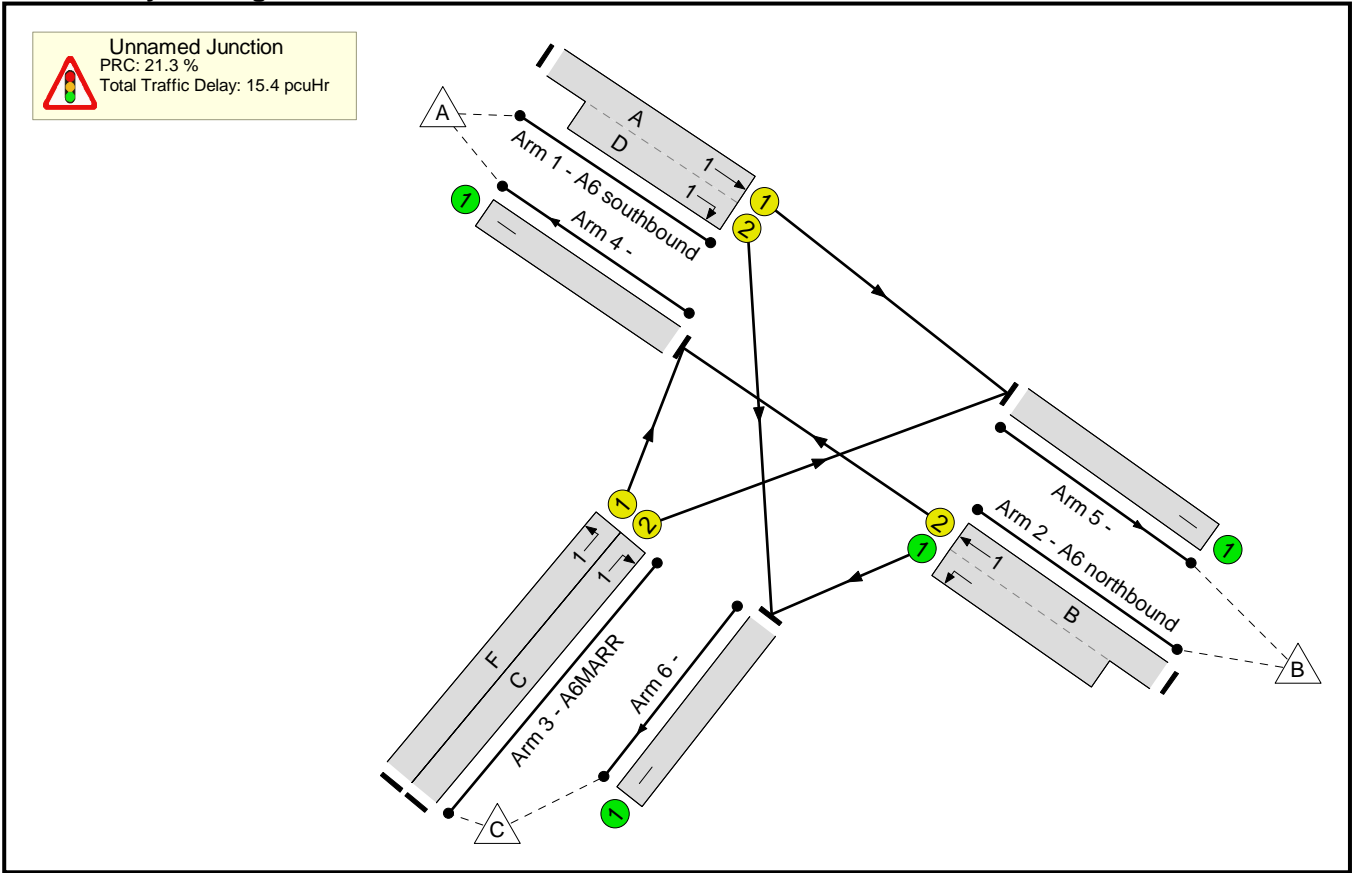

Network Results

Item	Lane Description	Lane Type	Controller Stream	Position In Filtered Route	Full Phase	Arrow Phase	Num Greens	Total Green (s)	Arrow Green (s)	Demand Flow (pcu)	Sat Flow (pcu/Hr)	Capacity (pcu)	Deg Sat (%)
Network: A6MARR / A6	-	-	N/A	-	-		-	-	-	-	-	-	74.2%
Unnamed Junction	-	-	N/A	-	-		-	-	-	-	-	-	74.2%
1/1+1/2	A6 southbound Ahead Right	U	1	N/A	A D		1	34:7	-	467	1985:1919	648	72.0%
2/2+2/1	A6 northbound Ahead Left	U	1	N/A	B -		1	21	-	1278	2035:2000	2006	63.7%
3/1	A6MARR Left	U	1	N/A	F		1	86	-	110	1832	1328	8.3%
3/2	A6MARR Right	U	1	N/A	C		1	76	-	959	2014	1292	74.2%
4/1		U	N/A	N/A	-		-	-	-	320	Inf	Inf	0.0%
5/1		U	N/A	N/A	-		-	-	-	1377	Inf	Inf	0.0%
6/1		U	N/A	N/A	-		-	-	-	1117	Inf	Inf	0.0%

Item	Arriving (pcu)	Leaving (pcu)	Turners In Gaps (pcu)	Turners When Unopposed (pcu)	Turners In Intergreen (pcu)	Uniform Delay (pcuHr)	Rand + Oversat Delay (pcuHr)	Storage Area Uniform Delay (pcuHr)	Total Delay (pcuHr)	Av. Delay Per PCU (s/pcu)	Max. Back of Uniform Queue (pcu)	Rand + Oversat Queue (pcu)	Mean Max Queue (pcu)
Network: A6MARR / A6	-	-	0	0	0	11.8	3.6	0.0	15.4	-	-	-	-
Unnamed Junction	-	-	0	0	0	11.8	3.6	0.0	15.4	-	-	-	-
1/1+1/2	467	467	-	-	-	5.2	1.3	-	6.4	49.6	12.4	1.3	13.7
2/2+2/1	1278	1278	-	-	-	2.6	0.9	-	3.5	9.8	6.4	0.9	7.2
3/1	110	110	-	-	-	0.1	0.0	-	0.2	6.3	1.1	0.0	1.1
3/2	959	959	-	-	-	3.9	1.4	-	5.3	20.1	21.8	1.4	23.3
4/1	320	320	-	-	-	0.0	0.0	-	0.0	0.0	0.0	0.0	0.0
5/1	1377	1377	-	-	-	0.0	0.0	-	0.0	0.0	0.0	0.0	0.0
6/1	1117	1117	-	-	-	0.0	0.0	-	0.0	0.0	0.0	0.0	0.0
C1			Stream: 1 PRC for Signalled Lanes (%):		21.3	Total Delay for Signalled Lanes (pcuHr):		15.45	Cycle Time (s): 120				
			PRC Over All Lanes (%):		21.3	Total Delay Over All Lanes(pcuHr):		15.45					

Scenario 2: 'PM 2017' (FG2: 'PM 2017', Plan 1: 'Network Control Plan 1')

Stage Sequence Diagram

Stage Stream: 1

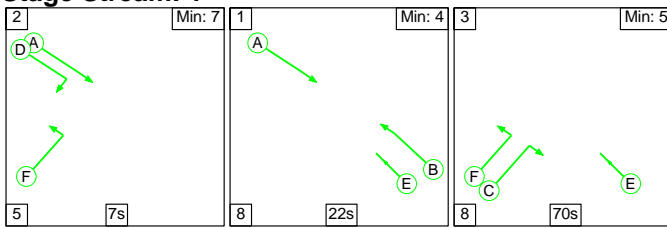

Stage Timings

Stage Stream: 1

Stage	2	1	3
Duration	7	22	70
Change Point	0	12	42

Signal Timings Diagram

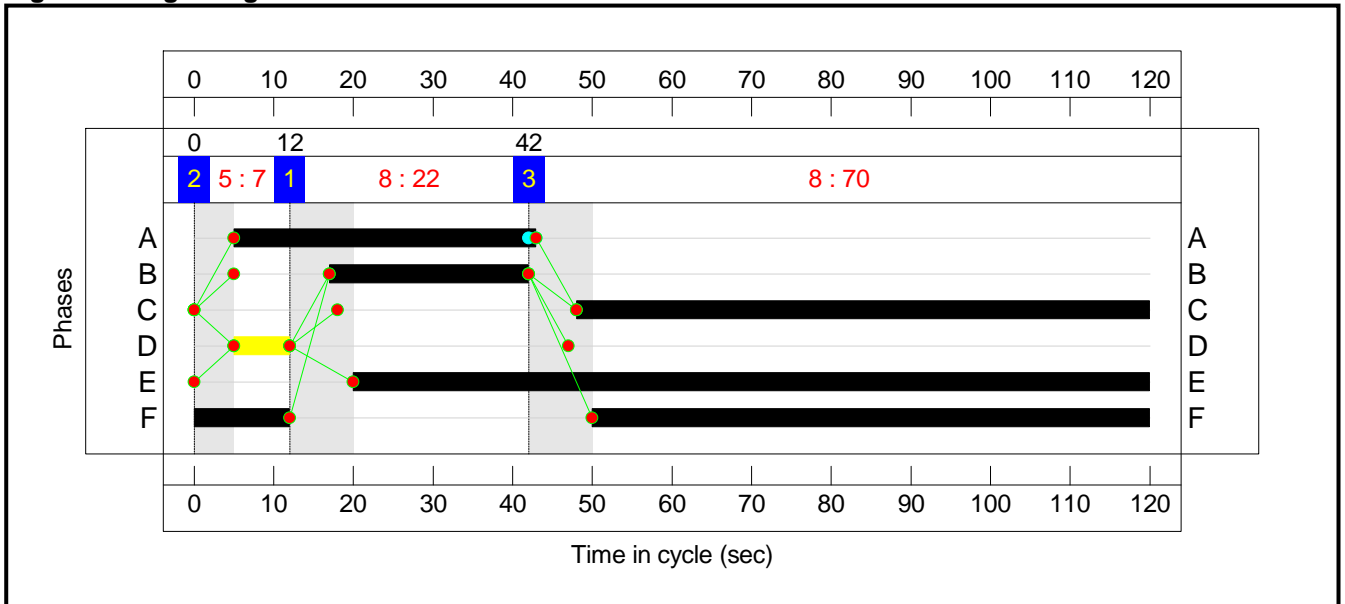

Network Layout Diagram

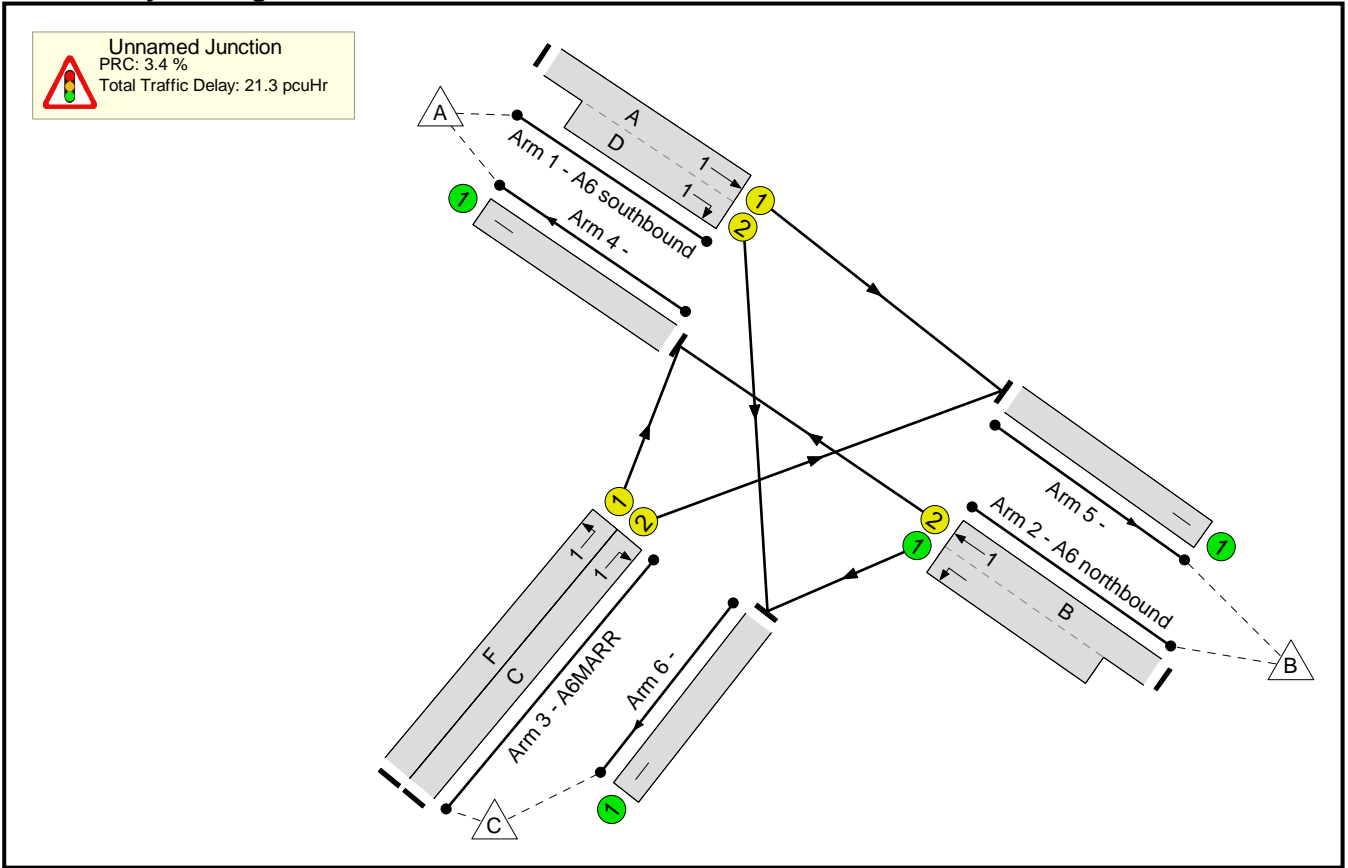

Network Results

Item	Lane Description	Lane Type	Controller Stream	Position In Filtered Route	Full Phase	Arrow Phase	Num Greens	Total Green (s)	Arrow Green (s)	Demand Flow (pcu)	Sat Flow (pcu/Hr)	Capacity (pcu)	Deg Sat (%)
Network: A6MARR / A6	-	-	N/A	-	-		-	-	-	-	-	-	87.0%
Unnamed Junction	-	-	N/A	-	-		-	-	-	-	-	-	87.0%
1/1+1/2	A6 southbound Ahead Right	U	1	N/A	A D		1	38:7	-	576	1985:1919	677	85.1%
2/2+2/1	A6 northbound Ahead Left	U	1	N/A	B -		1	25	-	1075	2035:2000	2007	53.6%
3/1	A6MARR Left	U	1	N/A	F		1	82	-	124	1832	1267	9.8%
3/2	A6MARR Right	U	1	N/A	C		1	72	-	1066	2014	1225	87.0%
4/1		U	N/A	N/A	-		-	-	-	352	Inf	Inf	0.0%
5/1		U	N/A	N/A	-		-	-	-	1615	Inf	Inf	0.0%
6/1		U	N/A	N/A	-		-	-	-	874	Inf	Inf	0.0%

Item	Arriving (pcu)	Leaving (pcu)	Turners In Gaps (pcu)	Turners When Unopposed (pcu)	Turners In Intergreen (pcu)	Uniform Delay (pcuHr)	Rand + Oversat Delay (pcuHr)	Storage Area Uniform Delay (pcuHr)	Total Delay (pcuHr)	Av. Delay Per PCU (s/pcu)	Max. Back of Uniform Queue (pcu)	Rand + Oversat Queue (pcu)	Mean Max Queue (pcu)
Network: A6MARR / A6	-	-	0	0	0	14.8	6.6	0.0	21.3	-	-	-	-
Unnamed Junction	-	-	0	0	0	14.8	6.6	0.0	21.3	-	-	-	-
1/1+1/2	576	576	-	-	-	6.2	2.7	-	8.9	55.4	16.9	2.7	19.6
2/2+2/1	1075	1075	-	-	-	2.6	0.6	-	3.2	10.7	6.6	0.6	7.2
3/1	124	124	-	-	-	0.2	0.1	-	0.3	7.7	1.3	0.1	1.4
3/2	1066	1066	-	-	-	5.8	3.2	-	9.0	30.4	29.3	3.2	32.5
4/1	352	352	-	-	-	0.0	0.0	-	0.0	0.0	0.0	0.0	0.0
5/1	1615	1615	-	-	-	0.0	0.0	-	0.0	0.0	0.0	0.0	0.0
6/1	874	874	-	-	-	0.0	0.0	-	0.0	0.0	0.0	0.0	0.0
C1 Stream: 1 PRC for Signalled Lanes (%): 3.4 Total Delay for Signalled Lanes (pcuHr): 21.35 Cycle Time (s): 120 PRC Over All Lanes (%): 3.4 Total Delay Over All Lanes(pcuHr): 21.35													

Appendix F.2

Realigned A6/ Buxton Road LinSig Output

Realigned A6/ Buxton Road LinSig Output

Full Input Data And Results

User and Project Details

Project:	A6MARR
Title:	A6 / Buxton Road
Location:	
File name:	1a. A6_BuxtonRd_DT1.lsg3x
Author:	PM
Company:	Atkins
Address:	Bank Chambers, Faulkner Street, Manchester
Notes:	

Network Layout Diagram

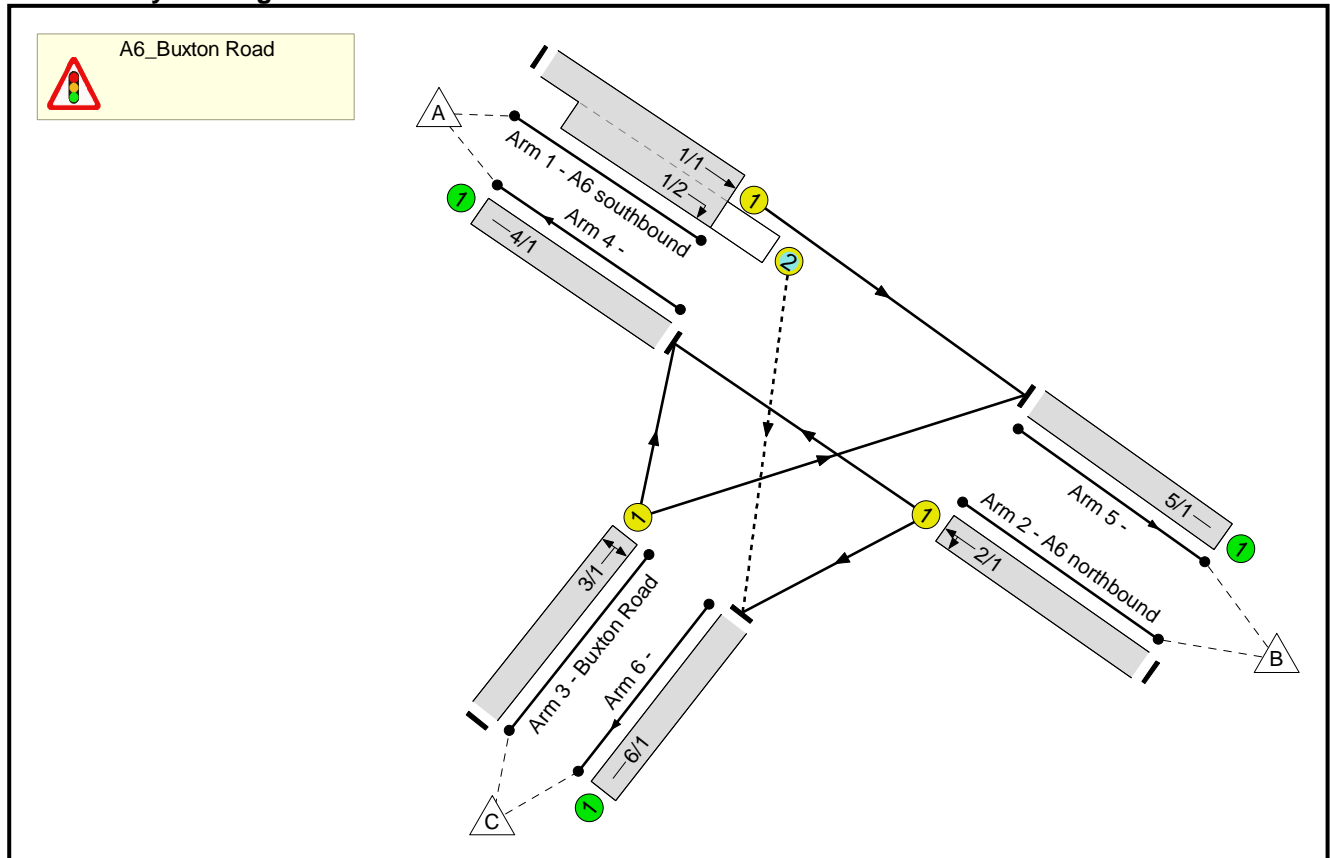

Phase Diagram

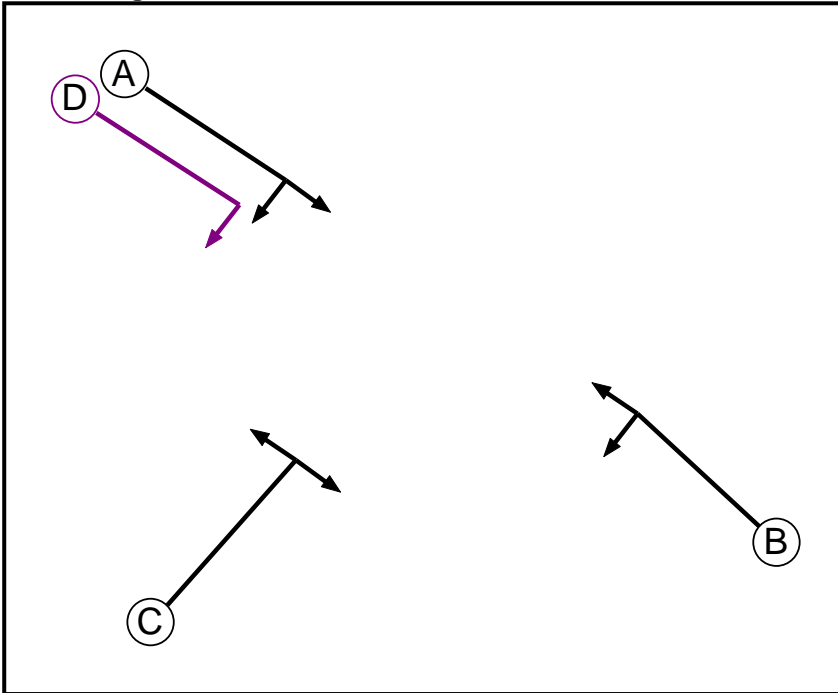

Phase Input Data

Phase Name	Phase Type	Stage Stream	Assoc. Phase	Street Min	Cont Min
A	Traffic	1		-9999	7
B	Traffic	1		-9999	7
C	Traffic	1		-9999	7
D	Ind. Arrow	1	A	-9999	4

Phase Intergreens Matrix

		Starting Phase			
		A	B	C	D
Terminating Phase	A	-	5	-	
	B	-	7	5	
	C	5	5	5	
	D	-	6	5	

Phases in Stage

Stream	Stage No.	Phases in Stage
1	1	A D
1	2	A B
1	3	C

Stage Diagram
Stage Stream: 1

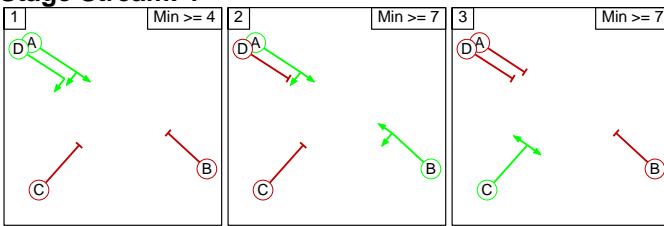

Phase Delays
Stage Stream: 1

Term. Stage	Start Stage	Phase	Type	Value	Cont value
There are no Phase Delays defined					

Prohibited Stage Change
Stage Stream: 1

From Stage	To Stage		
	1	2	3
1		6	5
2	5		7
3	5	5	

Give-Way Lane Input Data

Junction: A6_Buxton Road											
Lane	Movement	Max Flow when Giving Way (PCU/Hr)	Min Flow when Giving Way (PCU/Hr)	Opposing Lane	Opp. Lane Coeff.	Opp. Mvmnts.	Right Turn Storage (PCU)	Non-Blocking Storage (PCU)	RTF	Right Turn Move up (s)	Max Turns in Intergreen (PCU)
1/2 (A6 southbound)	6/1 (Right)	1440	0	2/1	1.09	All	3.00	-	0.50	3	2.00

Lane Input Data

Junction: A6_Buxton Road												
Lane	Lane Type	Phases	Start Disp.	End Disp.	Physical Length (PCU)	Sat Flow Type	Def User Saturation Flow (PCU/Hr)	Lane Width (m)	Gradient	Nearside Lane	Turns	Turning Radius (m)
1/1 (A6 southbound)	U	A	2	3	60.0	Geom	-	3.65	0.00	Y	Arm 5 Ahead	Inf
1/2 (A6 southbound)	O	A D	2	3	9.6	Geom	-	3.65	0.00	N	Arm 6 Right	14.00
2/1 (A6 northbound)	U	B	2	3	60.0	Geom	-	3.65	0.00	Y	Arm 4 Ahead Arm 6 Left	Inf 12.00
3/1 (Buxton Road)	U	C	2	3	60.0	Geom	-	4.60	0.00	Y	Arm 4 Left Arm 5 Right	14.00 15.00
4/1	U		2	3	60.0	Inf	-	-	-	-	-	-
5/1	U		2	3	60.0	Inf	-	-	-	-	-	-
6/1	U		2	3	60.0	Inf	-	-	-	-	-	-

Traffic Flow Groups

Flow Group	Start Time	End Time	Duration	Formula
1: 'AM 2017'	08:00	09:00	01:00	
2: 'PM 2017'	16:00	17:00	01:00	

Scenario 1: 'AM 2017' (FG1: 'AM 2017', Plan 1: 'Network Control Plan 1')

Traffic Flows, Desired

Desired Flow :

Origin	Destination				
	A	B	C	Tot.	
A	0	1298	80	1378	
B	1193	0	49	1242	
C	84	58	0	142	
Tot.	1277	1356	129	2762	

Traffic Lane Flows

Lane	Scenario 1: AM 2017
Junction: A6_Buxton Road	
1/1 (with short)	1378(In) 1298(Out)
1/2 (short)	80
2/1	1242
3/1	142
4/1	1277
5/1	1356
6/1	129

Lane Saturation Flows

Junction: A6_Buxton Road									
Lane	Lane Width (m)	Gradient	Nearside Lane	Allowed Turns	Turning Radius (m)	Turning Prop.	Sat Flow (PCU/Hr)	Flared Sat Flow (PCU/Hr)	
1/1 (A6 southbound)	3.65	0.00	Y	Arm 5 Ahead	Inf	100.0 %	1980	1980	
1/2 (A6 southbound)	3.65	0.00	N	Arm 6 Right	14.00	100.0 %	1915	1915	
2/1 (A6 northbound)	3.65	0.00	Y	Arm 4 Ahead	Inf	96.1 %	1970	1970	
				Arm 6 Left	12.00	3.9 %			
3/1 (Buxton Road)	4.60	0.00	Y	Arm 4 Left	14.00	59.2 %	1879	1879	
				Arm 5 Right	15.00	40.8 %			
4/1	Infinite Saturation Flow							Inf	Inf
5/1	Infinite Saturation Flow							Inf	Inf
6/1	Infinite Saturation Flow							Inf	Inf

Scenario 2: 'PM 2017' (FG2: 'PM 2017', Plan 1: 'Network Control Plan 1')

Traffic Flows, Desired

Desired Flow :

	Destination				
	A	B	C	Tot.	
Origin	A	0	1524	91	1615
	B	1027	0	15	1042
	C	48	25	0	73
	Tot.	1075	1549	106	2730

Traffic Lane Flows

Lane	Scenario 2: PM 2017
Junction: A6_Buxton Road	
1/1 (with short)	1615(In) 1524(Out)
1/2 (short)	91
2/1	1042
3/1	73
4/1	1075
5/1	1549
6/1	106

Lane Saturation Flows

Junction: A6_Buxton Road									
Lane	Lane Width (m)	Gradient	Nearside Lane	Allowed Turns	Turning Radius (m)	Turning Prop.	Sat Flow (PCU/Hr)	Flared Sat Flow (PCU/Hr)	
1/1 (A6 southbound)	3.65	0.00	Y	Arm 5 Ahead	Inf	100.0 %	1980	1980	
1/2 (A6 southbound)	3.65	0.00	N	Arm 6 Right	14.00	100.0 %	1915	1915	
2/1 (A6 northbound)	3.65	0.00	Y	Arm 4 Ahead	Inf	98.6 %	1976	1976	
				Arm 6 Left	12.00	1.4 %			
3/1 (Buxton Road)	4.60	0.00	Y	Arm 4 Left	14.00	65.8 %	1878	1878	
				Arm 5 Right	15.00	34.2 %			
4/1	Infinite Saturation Flow							Inf	Inf
5/1	Infinite Saturation Flow							Inf	Inf
6/1	Infinite Saturation Flow							Inf	Inf

Scenario 1: 'AM 2017' (FG1: 'AM 2017', Plan 1: 'Network Control Plan 1')

Stage Sequence Diagram

Stage Stream: 1

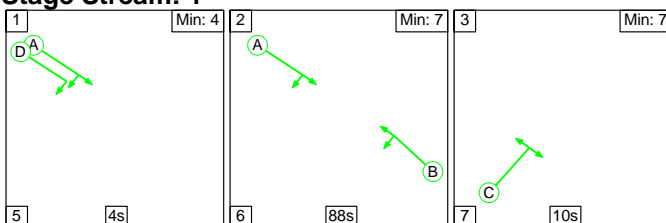

Stage Timings

Stage Stream: 1

Stage	1	2	3
Duration	4	88	10
Change Point	0	9	103

Signal Timings Diagram

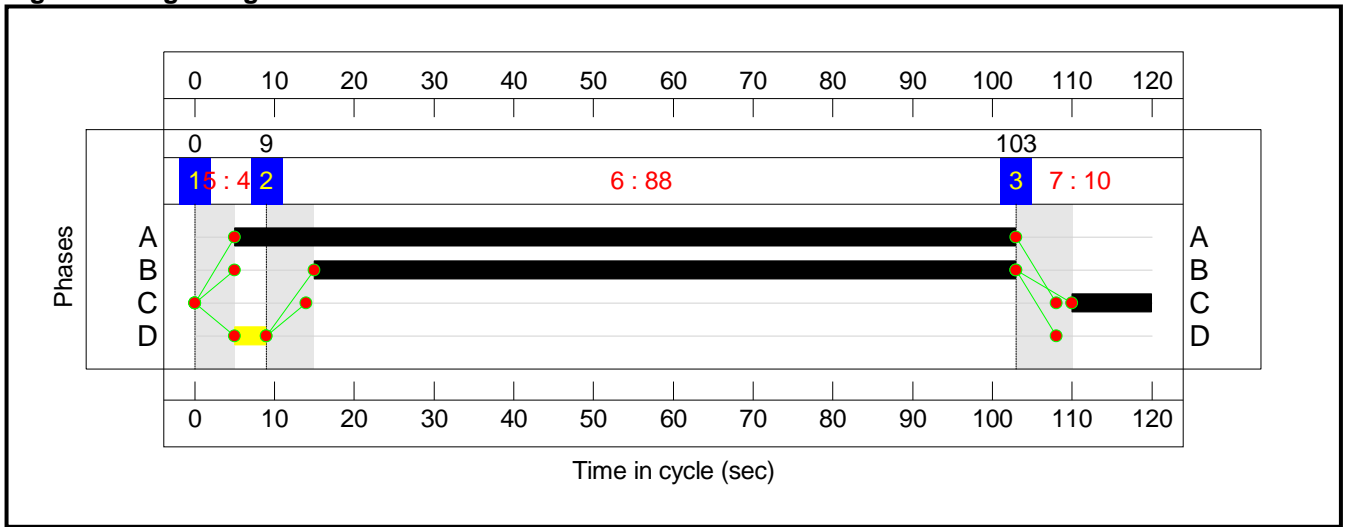

Network Layout Diagram

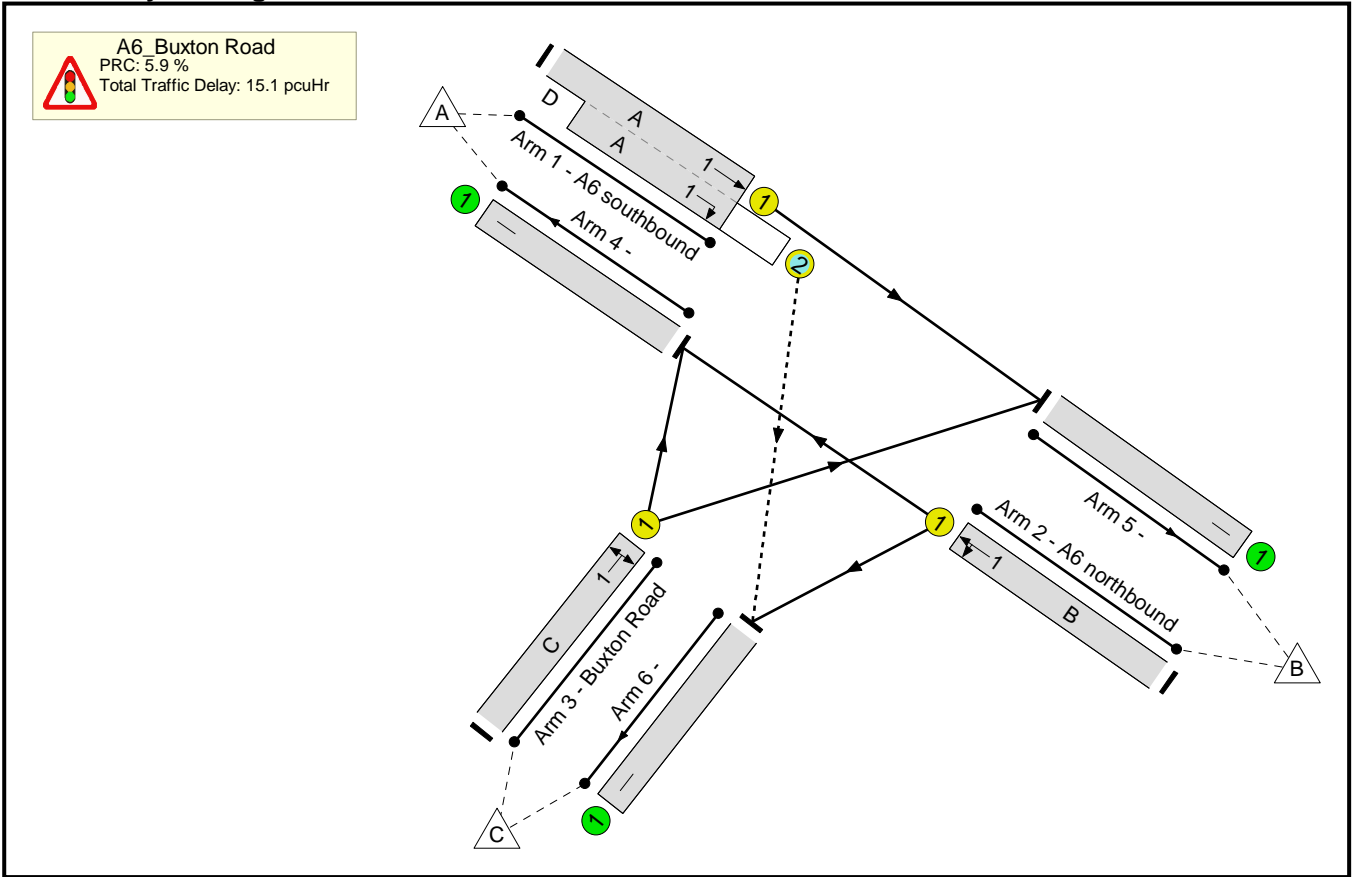

Network Results

Item	Lane Description	Lane Type	Controller Stream	Position In Filtered Route	Full Phase	Arrow Phase	Num Greens	Total Green (s)	Arrow Green (s)	Demand Flow (pcu)	Sat Flow (pcu/Hr)	Capacity (pcu)	Deg Sat (%)
Network: A6 / Buxton Road	-	-	N/A	-	-		-	-	-	-	-	-	85.0%
A6_Buxton Road	-	-	N/A	-	-		-	-	-	-	-	-	85.0%
1/1+1/2	A6 southbound Ahead Right	U+O	1	N/A	A	D	1	100	4	1378	1980:1915	1696	81.3%
2/1	A6 northbound Ahead Left	U	1	N/A	B		1	88	-	1242	1970	1461	85.0%
3/1	Buxton Road Left Right	U	1	N/A	C		1	10	-	142	1879	172	82.4%
4/1		U	N/A	N/A	-		-	-	-	1277	Inf	Inf	0.0%
5/1		U	N/A	N/A	-		-	-	-	1356	Inf	Inf	0.0%
6/1		U	N/A	N/A	-		-	-	-	129	Inf	Inf	0.0%

Item	Arriving (pcu)	Leaving (pcu)	Turners In Gaps (pcu)	Turners When Unopposed (pcu)	Turners In Intergreen (pcu)	Uniform Delay (pcuHr)	Rand + Oversat Delay (pcuHr)	Storage Area Uniform Delay (pcuHr)	Total Delay (pcuHr)	Av. Delay Per PCU (s/pcu)	Max. Back of Uniform Queue (pcu)	Rand + Oversat Queue (pcu)	Mean Max Queue (pcu)
Network: A6 / Buxton Road	-	-	26	17	37	7.5	7.0	0.6	15.1	-	-	-	-
A6_Buxton Road	-	-	26	17	37	7.5	7.0	0.6	15.1	-	-	-	-
1/1+1/2	1378	1378	26	17	37	1.6	2.1	0.6	4.4	11.5	21.1	2.1	23.2
2/1	1242	1242	-	-	-	3.7	2.8	-	6.5	18.8	28.6	2.8	31.4
3/1	142	142	-	-	-	2.1	2.1	-	4.2	105.9	4.6	2.1	6.7
4/1	1277	1277	-	-	-	0.0	0.0	-	0.0	0.0	0.0	0.0	0.0
5/1	1356	1356	-	-	-	0.0	0.0	-	0.0	0.0	0.0	0.0	0.0
6/1	129	129	-	-	-	0.0	0.0	-	0.0	0.0	0.0	0.0	0.0
C1 - C1			Stream: 1 PRC for Signalled Lanes (%): 5.9		PRC Over All Lanes (%): 5.9		Total Delay for Signalled Lanes (pcuHr): 15.08		Total Delay Over All Lanes(pcuHr): 15.08		Cycle Time (s): 120		

Scenario 2: 'PM 2017' (FG2: 'PM 2017', Plan 1: 'Network Control Plan 1')

Stage Sequence Diagram

Stage Stream: 1

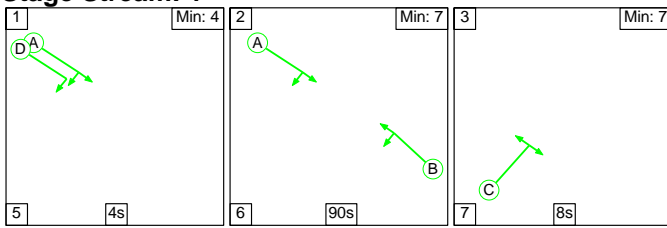

Stage Timings

Stage Stream: 1

Stage	1	2	3
Duration	4	90	8
Change Point	0	9	105

Signal Timings Diagram

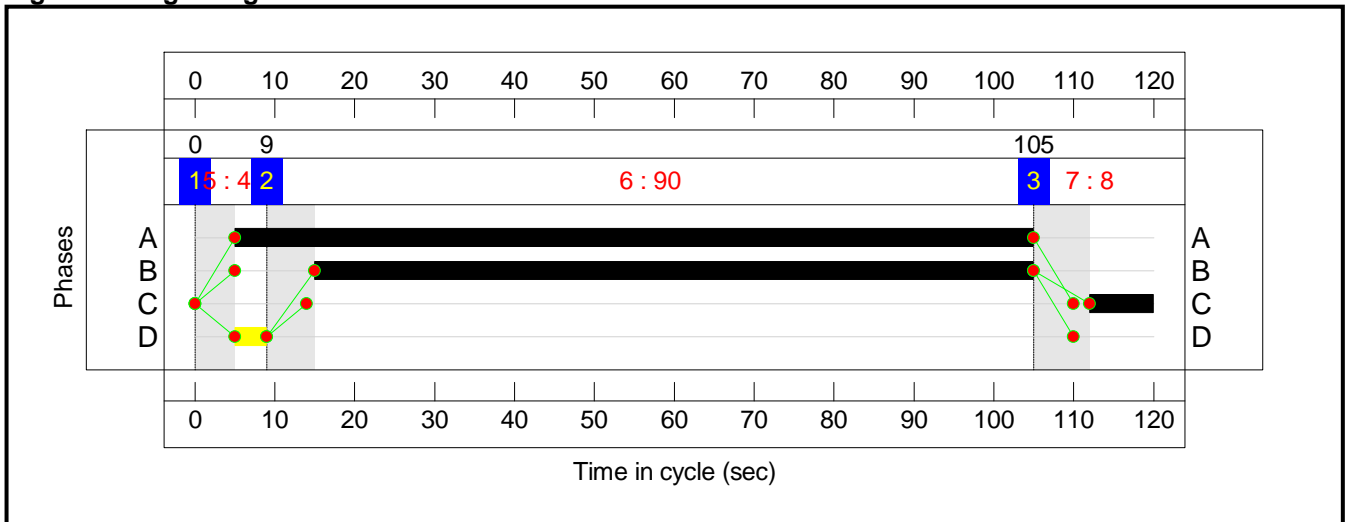

Network Layout Diagram

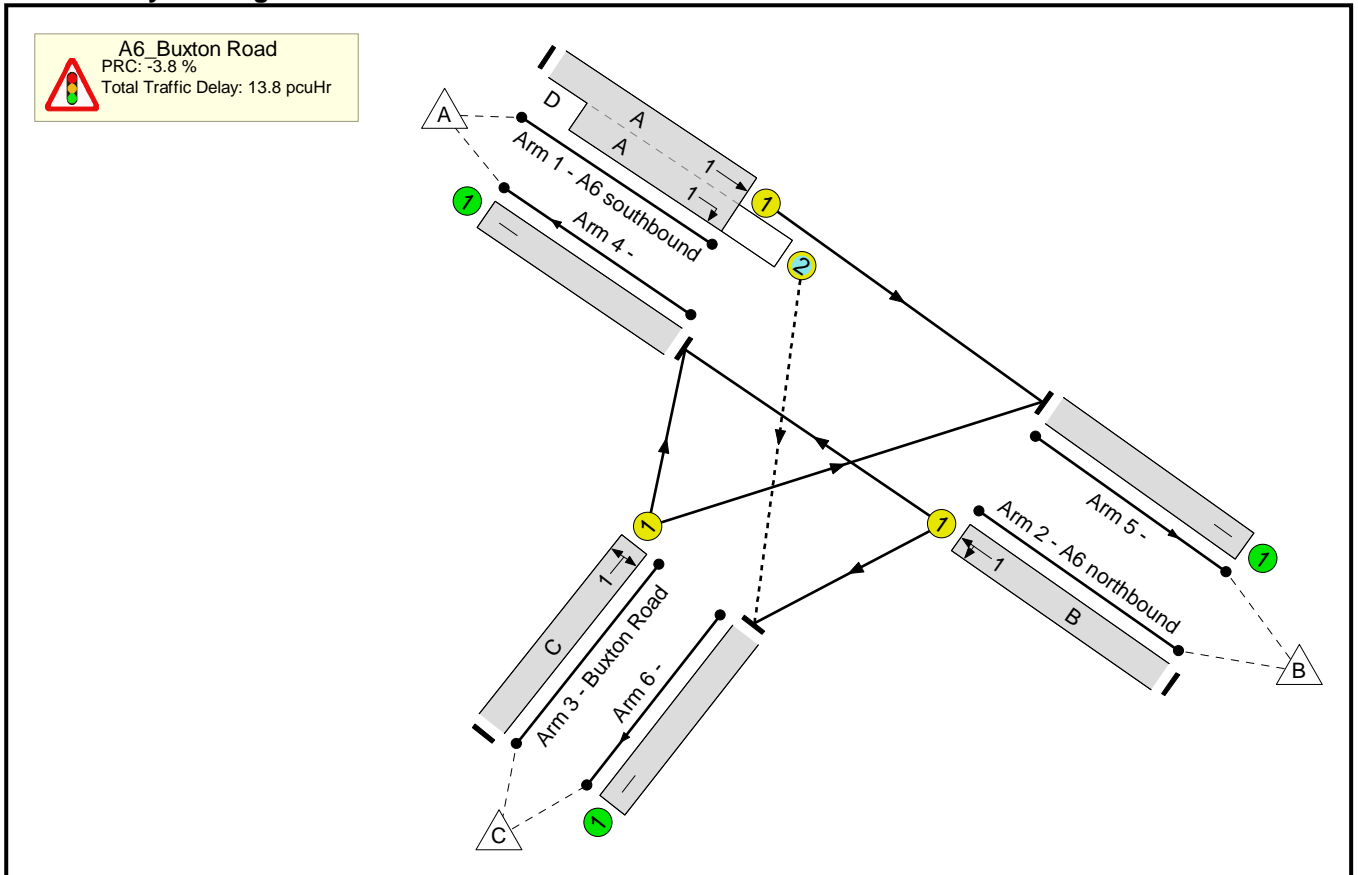

Network Results

Item	Lane Description	Lane Type	Controller Stream	Position In Filtered Route	Full Phase	Arrow Phase	Num Greens	Total Green (s)	Arrow Green (s)	Demand Flow (pcu)	Sat Flow (pcu/Hr)	Capacity (pcu)	Deg Sat (%)
Network: A6 / Buxton Road	-	-	N/A	-	-		-	-	-	-	-	-	93.4%
A6_Buxton Road	-	-	N/A	-	-		-	-	-	-	-	-	93.4%
1/1+1/2	A6 southbound Ahead Right	U+O	1	N/A	A	D	1	102	4	1615	1980:1915	1728	93.4%
2/1	A6 northbound Ahead Left	U	1	N/A	B		1	90	-	1042	1976	1498	69.5%
3/1	Buxton Road Left Right	U	1	N/A	C		1	8	-	73	1878	141	51.8%
4/1		U	N/A	N/A	-		-	-	-	1075	Inf	Inf	0.0%
5/1		U	N/A	N/A	-		-	-	-	1549	Inf	Inf	0.0%
6/1		U	N/A	N/A	-		-	-	-	106	Inf	Inf	0.0%

Item	Arriving (pcu)	Leaving (pcu)	Turners In Gaps (pcu)	Turners When Unopposed (pcu)	Turners In Intergreen (pcu)	Uniform Delay (pcuHr)	Rand + Oversat Delay (pcuHr)	Storage Area Uniform Delay (pcuHr)	Total Delay (pcuHr)	Av. Delay Per PCU (s/pcu)	Max. Back of Uniform Queue (pcu)	Rand + Oversat Queue (pcu)	Mean Max Queue (pcu)
Network: A6 / Buxton Road	-	-	71	18	2	5.7	8.1	0.1	13.8	-	-	-	-
A6_Buxton Road	-	-	71	18	2	5.7	8.1	0.1	13.8	-	-	-	-
1/1+1/2	1615	1615	71	18	2	2.4	6.4	0.1	9.0	20.0	36.2	6.4	42.6
2/1	1042	1042	-	-	-	2.1	1.1	-	3.3	11.3	17.7	1.1	18.8
3/1	73	73	-	-	-	1.1	0.5	-	1.6	79.6	2.3	0.5	2.9
4/1	1075	1075	-	-	-	0.0	0.0	-	0.0	0.0	0.0	0.0	0.0
5/1	1549	1549	-	-	-	0.0	0.0	-	0.0	0.0	0.0	0.0	0.0
6/1	106	106	-	-	-	0.0	0.0	-	0.0	0.0	0.0	0.0	0.0
C1 - C1			Stream: 1 PRC for Signalled Lanes (%): -3.8		PRC Over All Lanes (%): -3.8		Total Delay for Signalled Lanes (pcuHr): 13.85		Total Delay Over All Lanes (pcuHr): 13.85		Cycle Time (s): 120		

Appendix F.3

A6MARR/ A523 Macclesfield Road LinSig Output

A6MARR/ A523 Macclesfield Road LinSig Output

Full Input Data And Results

User and Project Details

Project:	A6MARR
Title:	A6MARR / Macclesfield Road / Fiveways
Location:	
File name:	2 - A6MARR_Macc Rd.lsg3x
Author:	PW
Company:	Atkins
Address:	Bank Chambers, Faulkner Street, Manchester
Notes:	

Network Layout Diagram

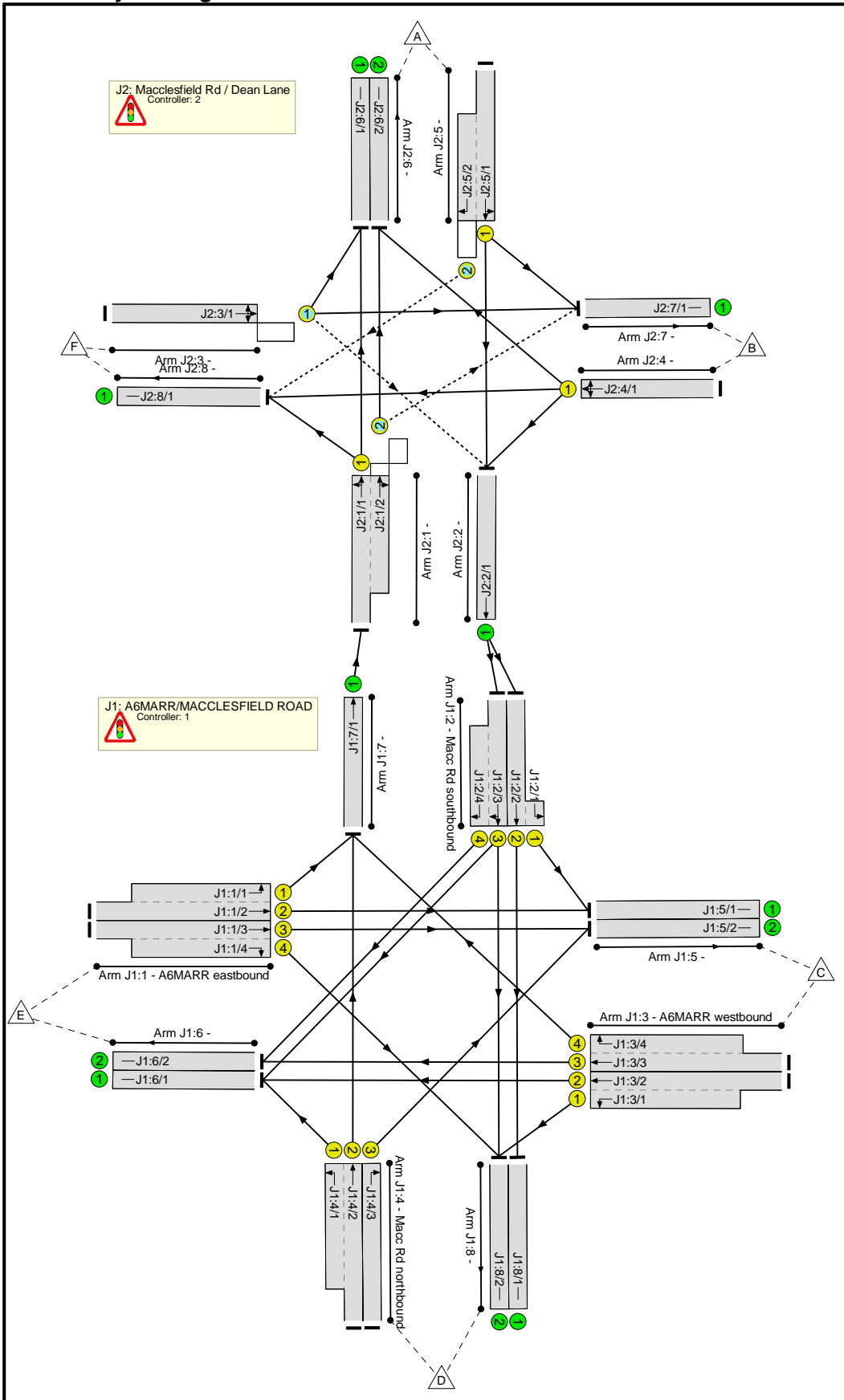

C1
Phase Diagram

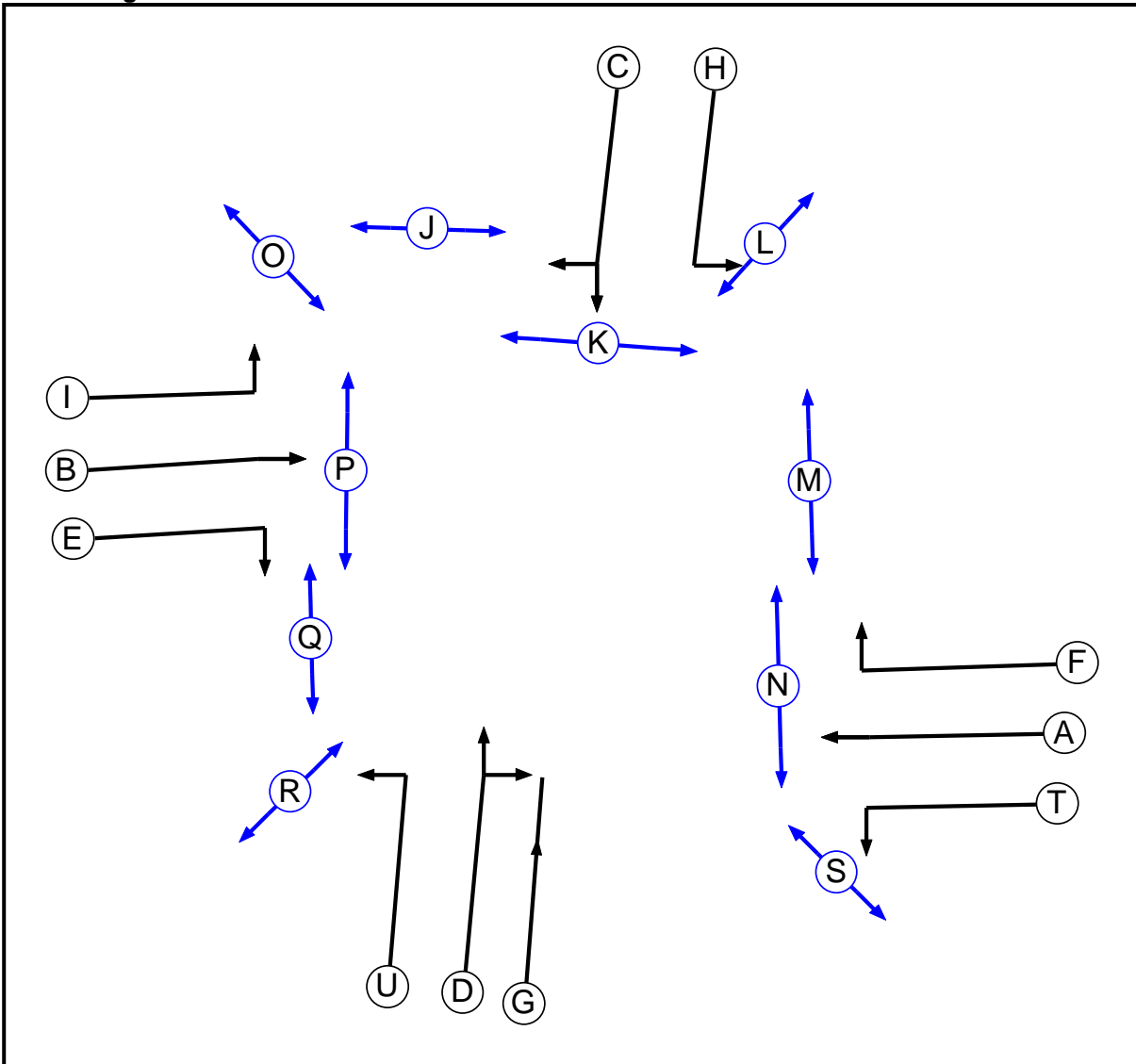

Phase Input Data

Phase Name	Phase Type	Assoc. Phase	Street Min	Cont Min
A	Traffic		7	7
B	Traffic		7	7
C	Traffic		7	7
D	Traffic		7	7
E	Traffic		0	0
F	Traffic		5	5
G	Traffic		7	7
H	Traffic		7	7
I	Traffic		7	7
J	Pedestrian		5	5
K	Pedestrian		7	7
L	Pedestrian		5	5
M	Pedestrian		2	2
N	Pedestrian		9	9
O	Pedestrian		5	5
P	Pedestrian		9	9
Q	Pedestrian		0	0
R	Pedestrian		5	5
S	Pedestrian		5	5
T	Traffic		7	7
U	Traffic		7	7

Phase Intergreens Matrix

		Starting Phase																				
		A	B	C	D	E	F	G	H	I	J	K	L	M	N	O	P	Q	R	S	T	U
Terminating Phase	A			5	7	5	-	7	-	-	-	-	-	-	5	-	-	9	-	-	-	9
	B			6	5	-	5	5	7	-	-	-	-	9	-	-	5	-	-	-	-	-
	C	6	5		6	5	6	6	-	-	-	5	5	-	-	-	-	11	-	-	8	10
	D	6	6	6		5	5	-	6	8	8	-	-	9	-	-	-	-	-	-	-	-
	E	6	-	5	5		-	5	-	-	-	-	-	-	-	-	5	-	-	-	8	-
	F	-	6	5	5	-		5	-	8	8	-	-	-	5	-	-	-	-	-	-	-
	G	6	6	6	-	5	5		6	8	8	-	-	9	-	-	-	-	-	-	-	-
	H	-	5	-	5	-	-	5		-	-	-	5	-	-	-	-	-	-	-	-	-
	I	-	-	-	5	-	5	5	-		-	-	-	-	-	6	-	-	-	-	-	-
	J	-	-	-	7	-	7	7	-	-		-	-	-	-	-	-	-	-	-	-	-
	K	-	-	12	-	-	-	-	-	-	-		-	-	-	-	-	-	-	-	-	-
	L	-	-	6	-	-	-	6	-	-	-	-		-	-	-	-	-	-	-	-	-
	M	-	8	-	8	-	-	8	-	-	-	-	-		-	-	-	-	-	-	-	-
	N	8	-	-	-	-	5	-	-	-	-	-	-	-		-	-	-	-	-	-	-
	O	-	-	-	-	-	-	-	-	5	-	-	-	-	-		-	-	-	-	-	-
	P	-	8	-	-	5	-	-	-	-	-	-	-	-	-	-		-	-	-	-	-
	Q	8	-	7	-	-	-	-	-	-	-	-	-	-	-	-	-		-	-	-	-
	R	-	-	-	-	-	-	-	-	-	-	-	-	-	-	-	-	-		-	-	7
	S	-	-	-	-	-	-	-	-	-	-	-	-	-	-	-	-	-	-		-	6
	T	-	-	5	-	5	-	-	-	-	-	-	-	-	-	-	-	-	-	-		5
U	5	-	5	-	-	-	-	-	-	-	-	-	-	-	-	-	-	-	-	-		

Phases in Stage

Stage No.	Phases in Stage
1	AFKOPRT
2	ABIKLRT
3	BEIJKLNRS
4	CHIJMNP RS
5	DKLNO PQ TU
6	EFHKMQU

Stage Diagram

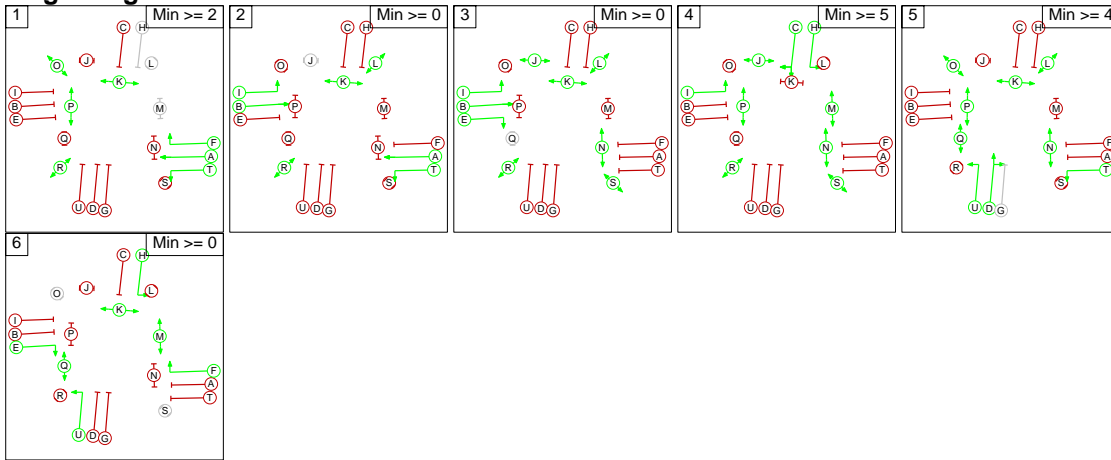

Phase Delays

Term. Stage	Start Stage	Phase	Type	Value	Cont value
1	2	F	Losing	2	2
1	2	O	Losing	5	5
3	4	B	Losing	5	5
3	4	E	Losing	7	7
3	4	L	Losing	6	6
4	5	C	Losing	2	2
4	5	H	Losing	3	3
4	5	I	Losing	3	3
4	5	J	Losing	1	1
4	5	R	Losing	3	3
4	5	S	Losing	2	2
6	1	E	Losing	2	2
6	1	U	Losing	3	3

Prohibited Stage Change

		To Stage					
		1	2	3	4	5	6
From Stage	1		10	8	12	9	9
	2	6		5	12	9	9
	3	8	8		14	8	9
	4	8	8	8		13	11
	5	8	8	8	12		9
	6	10	8	8	12	8	

C2
Phase Diagram

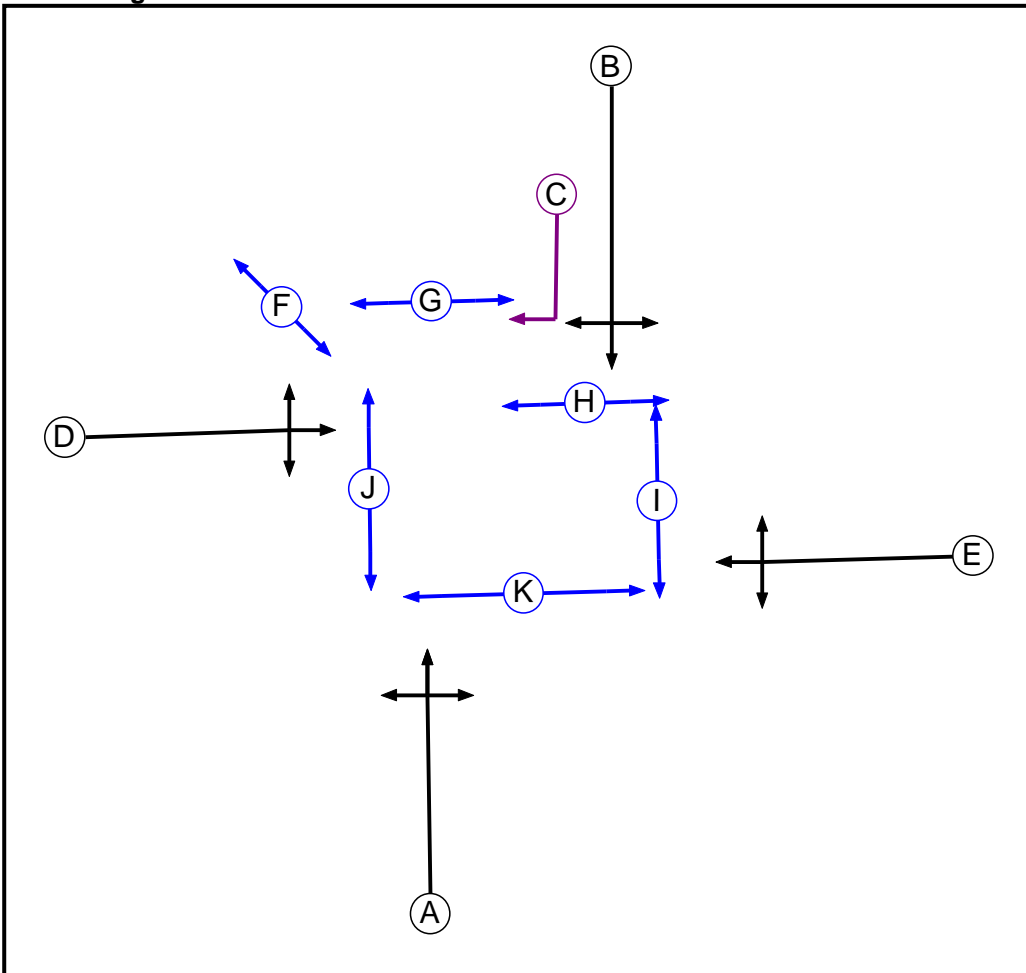

Phase Input Data

Phase Name	Phase Type	Stage Stream	Assoc. Phase	Street Min	Cont Min
A	Traffic	1		-9999	7
B	Traffic	1		-9999	7
C	Ind. Arrow	1	B	-9999	4
D	Traffic	1		-9999	7
E	Traffic	1		-9999	7
F	Pedestrian	1		-9999	5
G	Pedestrian	1		-9999	5
H	Pedestrian	1		-9999	5
I	Pedestrian	1		-9999	5
J	Pedestrian	1		-9999	8
K	Pedestrian	1		-9999	6

Phase Intergreens Matrix

		Starting Phase										
		A	B	C	D	E	F	G	H	I	J	K
Terminating Phase	A		-	5	7	7	-	7	-	10	7	5
	B	-		-	7	7	-	-	5	8	10	8
	C	4	-		7	7	-	-	5	-	10	-
	D	5	5	5		-	5	-	-	8	5	9
	E	6	6	6	-		-	9	-	5	8	7
	F	-	-	-	6	-		-	-	-	-	-
	G	5	-	-	-	5	-		-	-	-	-
	H	-	6	6	-	-	-	-		-	-	-
	I	8	7	-	8	8	-	-	-		-	-
	J	12	10	10	12	12	-	-	-	-		-
	K	6	6	-	6	6	-	-	-	-	-	

Phases in Stage

Stream	Stage No.	Phases in Stage
1	1	B C F G
1	2	A B F
1	3	D E H
1	4	F G H I J K

Stage Diagram

Stage Stream: 1

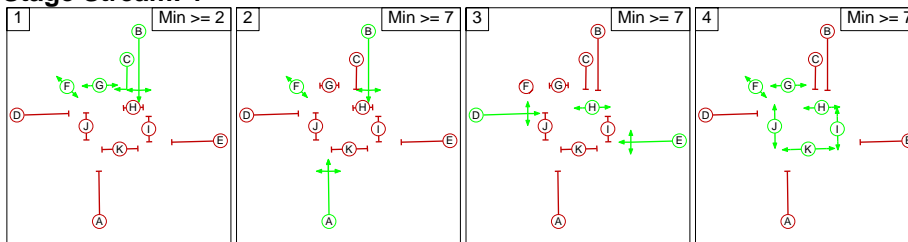

Phase Delays

Stage Stream: 1

Term. Stage	Start Stage	Phase	Type	Value	Cont value
2	3	F	Losing	1	1
4	1	H	Losing	4	4
4	1	I	Losing	3	3
4	1	K	Losing	4	4

**Prohibited Stage Change
 Stage Stream: 1**

		To Stage			
		1	2	3	4
From Stage	1		5	7	10
	2	7		7	10
	3	9	6		9
	4	10	12	12	

Give-Way Lane Input Data

Junction: J1: A6MARR/MACCLESFIELD ROAD

There are no Opposed Lanes in this Junction

Junction: J2: Macclesfield Rd / Dean Lane

Lane	Movement	Max Flow when Giving Way (PCU/Hr)	Min Flow when Giving Way (PCU/Hr)	Opposing Lane	Opp. Lane Coeff.	Opp. Mvmnts.	Right Turn Storage (PCU)	Non-Blocking Storage (PCU)	RTF	Right Turn Move up (s)	Max Turns in Intergreen (PCU)
J2:1/2	J2:7/1 (Right)	1440	0	J2:5/1	1.09	All	3.00	2.00	0.50	3	3.00
J2:3/1	J2:2/1 (Right)	1440	0	J2:4/1	1.09	To J2:2/1 (Left) To J2:8/1 (Ahead)	3.00	3.00	0.50	3	3.00
J2:5/2	J2:8/1 (Right)	1440	0	J2:1/1 J2:1/2	1.09 1.09	All To J2:6/2 (Ahead)	3.00	-	0.50	3	3.00

Lane Input Data

Junction: J1: A6MARR/MACCLESFIELD ROAD												
Lane	Lane Type	Phases	Start Disp.	End Disp.	Physical Length (PCU)	Sat Flow Type	Def User Saturation Flow (PCU/Hr)	Lane Width (m)	Gradient	Nearside Lane	Turns	Turning Radius (m)
J1:1/1 (A6MARR eastbound)	U	I	2	3	22.6	Geom	-	4.00	0.00	Y	Arm J1:7 Left	50.00
J1:1/2 (A6MARR eastbound)	U	B	2	3	60.0	Geom	-	3.65	0.00	N	Arm J1:5 Ahead	Inf
J1:1/3 (A6MARR eastbound)	U	B	2	3	60.0	Geom	-	3.65	0.00	N	Arm J1:5 Ahead	Inf
J1:1/4 (A6MARR eastbound)	U	E	2	3	14.1	Geom	-	3.65	0.00	Y	Arm J1:8 Right	17.00
J1:2/1 (Macc Rd southbound)	U	H	2	3	2.0	Geom	-	4.50	0.00	Y	Arm J1:5 Left	27.00
J1:2/2 (Macc Rd southbound)	U	C	2	3	60.0	Geom	-	3.65	0.00	Y	Arm J1:8 Ahead	Inf
J1:2/3 (Macc Rd southbound)	U	C	2	3	60.0	Geom	-	3.65	0.00	N	Arm J1:6 Right	Inf
J1:2/4 (Macc Rd southbound)	U	C	2	3	9.6	Geom	-	3.65	0.00	N	Arm J1:8 Ahead	Inf
J1:2/4 (Macc Rd southbound)	U	C	2	3	9.6	Geom	-	3.65	0.00	N	Arm J1:6 Right	20.00
J1:3/1 (A6MARR westbound)	U	T	2	3	12.2	Geom	-	3.65	0.00	Y	Arm J1:8 Left	55.00
J1:3/2 (A6MARR westbound)	U	A	2	3	100.0	Geom	-	3.65	0.00	N	Arm J1:6 Ahead	Inf
J1:3/3 (A6MARR westbound)	U	A	2	3	100.0	Geom	-	3.65	0.00	N	Arm J1:6 Ahead	Inf
J1:3/4 (A6MARR westbound)	U	F	2	3	13.2	Geom	-	3.65	0.00	Y	Arm J1:7 Right	17.00

J1:4/1 (Macc Rd northbound)	U	U	2	3	12.2	Geo m	-	4.70	0.00	Y	Arm J1:6 Left	23.00
J1:4/2 (Macc Rd northbound)	U	D	2	3	60.0	Geo m	-	3.65	0.00	N	Arm J1:7 Ahea d	Inf
J1:4/3 (Macc Rd northbound)	U	D	2	3	8.3	Geo m	-	3.65	0.00	N	Arm J1:5 Right	21.00
J1:5/1	U		2	3	60.0	Inf	-	-	-	-	-	-
J1:5/2	U		2	3	60.0	Inf	-	-	-	-	-	-
J1:6/1	U		2	3	60.0	Inf	-	-	-	-	-	-
J1:6/2	U		2	3	60.0	Inf	-	-	-	-	-	-
J1:7/1	U		2	3	60.0	Inf	-	-	-	-	-	-
J1:8/1	U		2	3	60.0	Inf	-	-	-	-	-	-
J1:8/2	U		2	3	60.0	Inf	-	-	-	-	-	-

Junction: J2: Macclesfield Rd / Dean Lane												
Lane	Lane Type	Phases	Start Disp.	End Disp.	Physical Length (PCU)	Sat Flow Type	Def User Saturation Flow (PCU/Hr)	Lane Width (m)	Gradient	Nearside Lane	Turns	Turning Radius (m)
J2:1/1	U	A	2	3	60.0	Geom	-	3.00	0.00	Y	Arm J2:6 Ahead	Inf
											Arm J2:8 Left	10.00
J2:1/2	O	A	2	3	22.6	Geom	-	3.00	0.00	N	Arm J2:6 Ahead	Inf
											Arm J2:7 Right	12.00
J2:2/1	U		2	3	60.0	Inf	-	-	-	-	-	-
J2:3/1	O	D	2	3	60.0	Geom	-	3.80	0.00	Y	Arm J2:2 Right	12.00
											Arm J2:6 Left	24.00
											Arm J2:7 Ahead	Inf
J2:4/1	U	E	2	3	60.0	Geom	-	3.09	0.00	Y	Arm J2:2 Left	12.00
											Arm J2:6 Right	12.00
											Arm J2:8 Ahead	Inf
J2:5/1	U	B	2	3	60.0	Geom	-	3.05	0.00	Y	Arm J2:2 Ahead	Inf
											Arm J2:7 Left	12.00
J2:5/2	O	B C	2	3	8.7	Geom	-	3.05	0.00	N	Arm J2:8 Right	12.00
J2:6/1	U		2	3	60.0	Inf	-	-	-	-	-	-
J2:6/2	U		2	3	60.0	Inf	-	-	-	-	-	-
J2:7/1	U		2	3	60.0	Inf	-	-	-	-	-	-
J2:8/1	U		2	3	60.0	Inf	-	-	-	-	-	-

Traffic Flow Groups

Flow Group	Start Time	End Time	Duration	Formula
2: 'am 2017'	08:00	09:00	01:00	
3: 'pm 2017'	17:00	18:00	01:00	

Scenario 1: 'AM 2017' (FG2: 'am 2017', Plan 2: 'Network Control Plan 2')
Traffic Flows, Desired
Desired Flow :

		Destination						
		A	B	C	D	E	F	Tot.
Origin	A	0	48	97	237	228	44	654
	B	59	0	11	38	37	0	145
	C	76	2	0	104	906	37	1125
	D	258	17	137	0	260	148	820
	E	260	17	749	59	0	149	1234
	F	20	0	75	193	186	0	474
	Tot.	673	84	1069	631	1617	378	4452

Traffic Lane Flows

Lane	Scenario 1: AM 2017
Junction: J1: A6MARR/MACCLESFIELD ROAD	
J1:1/1 (short)	426
J1:1/2 (with short)	806(In) 380(Out)
J1:1/3 (with short)	428(In) 369(Out)
J1:1/4 (short)	59
J1:2/1 (short)	183
J1:2/2 (with short)	396(In) 213(Out)
J1:2/3 (with short)	706(In) 366(Out)
J1:2/4 (short)	340
J1:3/1 (short)	104
J1:3/2 (with short)	557(In) 453(Out)
J1:3/3 (with short)	568(In) 453(Out)
J1:3/4 (short)	115
J1:4/1 (short)	260
J1:4/2 (with short)	683(In) 423(Out)
J1:4/3	137
J1:5/1	563
J1:5/2	506
J1:6/1	824
J1:6/2	793
J1:7/1	964
J1:8/1	213
J1:8/2	418

Lane	Scenario 1: AM 2017
Junction: J2: Macclesfield Rd / Dean Lane	
J2:1/1 (with short)	964(In) 444(Out)
J2:1/2 (short)	520
J2:2/1	1102
J2:3/1	474
J2:4/1	145
J2:5/1 (with short)	654(In) 610(Out)
J2:5/2 (short)	44
J2:6/1	130
J2:6/2	543
J2:7/1	84
J2:8/1	378

Lane Saturation Flows

Junction: J1: A6MARR/MACCLESFIELD ROAD								
Lane	Lane Width (m)	Gradient	Nearside Lane	Allowed Turns	Turning Radius (m)	Turning Prop.	Sat Flow (PCU/Hr)	Flared Sat Flow (PCU/Hr)
J1:1/1 (A6MARR eastbound)	4.00	0.00	Y	Arm J1:7 Left	50.00	100.0 %	1956	1956
J1:1/2 (A6MARR eastbound)	3.65	0.00	N	Arm J1:5 Ahead	Inf	100.0 %	2120	2120
J1:1/3 (A6MARR eastbound)	3.65	0.00	N	Arm J1:5 Ahead	Inf	100.0 %	2120	2120
J1:1/4 (A6MARR eastbound)	3.65	0.00	Y	Arm J1:8 Right	17.00	100.0 %	1819	1819
J1:2/1 (Macc Rd southbound)	4.50	0.00	Y	Arm J1:5 Left	27.00	100.0 %	1956	1956
J1:2/2 (Macc Rd southbound)	3.65	0.00	Y	Arm J1:8 Ahead	Inf	100.0 %	1980	1980
J1:2/3 (Macc Rd southbound)	3.65	0.00	N	Arm J1:6 Right Arm J1:8 Ahead	Inf Inf	30.3 % 69.7 %	2120	2120
J1:2/4 (Macc Rd southbound)	3.65	0.00	N	Arm J1:6 Right	20.00	100.0 %	1972	1972
J1:3/1 (A6MARR westbound)	3.65	0.00	Y	Arm J1:8 Left	55.00	100.0 %	1927	1927
J1:3/2 (A6MARR westbound)	3.65	0.00	N	Arm J1:6 Ahead	Inf	100.0 %	2120	2120
J1:3/3 (A6MARR westbound)	3.65	0.00	N	Arm J1:6 Ahead	Inf	100.0 %	2120	2120
J1:3/4 (A6MARR westbound)	3.65	0.00	Y	Arm J1:7 Right	17.00	100.0 %	1819	1819
J1:4/1 (Macc Rd northbound)	4.70	0.00	Y	Arm J1:6 Left	23.00	100.0 %	1957	1957
J1:4/2 (Macc Rd northbound)	3.65	0.00	N	Arm J1:7 Ahead	Inf	100.0 %	2120	2120
J1:4/3 (Macc Rd northbound)	3.65	0.00	N	Arm J1:5 Right	21.00	100.0 %	1979	1979
J1:5/1				Infinite Saturation Flow			Inf	Inf
J1:5/2				Infinite Saturation Flow			Inf	Inf
J1:6/1				Infinite Saturation Flow			Inf	Inf
J1:6/2				Infinite Saturation Flow			Inf	Inf
J1:7/1				Infinite Saturation Flow			Inf	Inf
J1:8/1				Infinite Saturation Flow			Inf	Inf
J1:8/2				Infinite Saturation Flow			Inf	Inf

Junction: J2: Macclesfield Rd / Dean Lane								
Lane	Lane Width (m)	Gradient	Nearside Lane	Allowed Turns	Turning Radius (m)	Turning Prop.	Sat Flow (PCU/Hr)	Flared Sat Flow (PCU/Hr)
J2:1/1	3.00	0.00	Y	Arm J2:6 Ahead Arm J2:8 Left	Inf 10.00	24.8 % 75.2 %	1721	1721
J2:1/2	3.00	0.00	N	Arm J2:6 Ahead Arm J2:7 Right	Inf 12.00	93.1 % 6.9 %	2037	2037
J2:2/1	Infinite Saturation Flow						Inf	Inf
J2:3/1	3.80	0.00	Y	Arm J2:2 Right Arm J2:6 Left Arm J2:7 Ahead Arm J2:2 Left	12.00 24.00 Inf 12.00	95.8 % 4.2 % 0.0 % 59.3 %	1778	1778
J2:4/1	3.09	0.00	Y	Arm J2:6 Right Arm J2:8 Ahead	12.00 Inf	40.7 % 0.0 %	1710	1710
J2:5/1	3.05	0.00	Y	Arm J2:2 Ahead Arm J2:7 Left	Inf 12.00	92.1 % 7.9 %	1901	1901
J2:5/2	3.05	0.00	N	Arm J2:8 Right	12.00	100.0 %	1831	1831
J2:6/1	Infinite Saturation Flow						Inf	Inf
J2:6/2	Infinite Saturation Flow						Inf	Inf
J2:7/1	Infinite Saturation Flow						Inf	Inf
J2:8/1	Infinite Saturation Flow						Inf	Inf

Scenario 2: 'PM 2017' (FG3: 'pm 2017', Plan 2: 'Network Control Plan 2')

Traffic Flows, Desired

Desired Flow :

	Destination							
	A	B	C	D	E	F	Tot.	
Origin	A	0	78	51	296	198	23	646
	B	45	0	1	16	8	0	70
	C	51	2	0	78	728	15	874
	D	301	25	182	0	54	120	682
	E	529	59	926	136	0	240	1890
	F	64	0	30	203	130	0	427
	Tot.	990	164	1190	729	1118	398	4589

Traffic Lane Flows

Lane	Scenario 2: PM 2017
Junction: J1: A6MARR/MACCLESFIELD ROAD	
J1:1/1 (short)	828
J1:1/2 (with short)	1215(In) 387(Out)
J1:1/3 (with short)	675(In) 539(Out)
J1:1/4 (short)	136
J1:2/1 (short)	82
J1:2/2 (with short)	308(In) 226(Out)
J1:2/3 (with short)	625(In) 324(Out)
J1:2/4 (short)	301
J1:3/1 (short)	78
J1:3/2 (with short)	443(In) 365(Out)
J1:3/3 (with short)	431(In) 363(Out)
J1:3/4 (short)	68
J1:4/1 (short)	54
J1:4/2 (with short)	500(In) 446(Out)
J1:4/3	182
J1:5/1	469
J1:5/2	721
J1:6/1	454
J1:6/2	664
J1:7/1	1342
J1:8/1	226
J1:8/2	503

Lane	Scenario 2: PM 2017
Junction: J2: Macclesfield Rd / Dean Lane	
J2:1/1 (with short)	1342(In) 676(Out)
J2:1/2 (short)	666
J2:2/1	933
J2:3/1	427
J2:4/1	70
J2:5/1 (with short)	646(In) 623(Out)
J2:5/2 (short)	23
J2:6/1	365
J2:6/2	625
J2:7/1	164
J2:8/1	398

Lane Saturation Flows

Junction: J1: A6MARR/MACCLESFIELD ROAD								
Lane	Lane Width (m)	Gradient	Nearside Lane	Allowed Turns	Turning Radius (m)	Turning Prop.	Sat Flow (PCU/Hr)	Flared Sat Flow (PCU/Hr)
J1:1/1 (A6MARR eastbound)	4.00	0.00	Y	Arm J1:7 Left	50.00	100.0 %	1956	1956
J1:1/2 (A6MARR eastbound)	3.65	0.00	N	Arm J1:5 Ahead	Inf	100.0 %	2120	2120
J1:1/3 (A6MARR eastbound)	3.65	0.00	N	Arm J1:5 Ahead	Inf	100.0 %	2120	2120
J1:1/4 (A6MARR eastbound)	3.65	0.00	Y	Arm J1:8 Right	17.00	100.0 %	1819	1819
J1:2/1 (Macc Rd southbound)	4.50	0.00	Y	Arm J1:5 Left	27.00	100.0 %	1956	1956
J1:2/2 (Macc Rd southbound)	3.65	0.00	Y	Arm J1:8 Ahead	Inf	100.0 %	1980	1980
J1:2/3 (Macc Rd southbound)	3.65	0.00	N	Arm J1:6 Right Arm J1:8 Ahead	Inf Inf	10.8 % 89.2 %	2120	2120
J1:2/4 (Macc Rd southbound)	3.65	0.00	N	Arm J1:6 Right	20.00	100.0 %	1972	1972
J1:3/1 (A6MARR westbound)	3.65	0.00	Y	Arm J1:8 Left	55.00	100.0 %	1927	1927
J1:3/2 (A6MARR westbound)	3.65	0.00	N	Arm J1:6 Ahead	Inf	100.0 %	2120	2120
J1:3/3 (A6MARR westbound)	3.65	0.00	N	Arm J1:6 Ahead	Inf	100.0 %	2120	2120
J1:3/4 (A6MARR westbound)	3.65	0.00	Y	Arm J1:7 Right	17.00	100.0 %	1819	1819
J1:4/1 (Macc Rd northbound)	4.70	0.00	Y	Arm J1:6 Left	23.00	100.0 %	1957	1957
J1:4/2 (Macc Rd northbound)	3.65	0.00	N	Arm J1:7 Ahead	Inf	100.0 %	2120	2120
J1:4/3 (Macc Rd northbound)	3.65	0.00	N	Arm J1:5 Right	21.00	100.0 %	1979	1979
J1:5/1				Infinite Saturation Flow			Inf	Inf
J1:5/2				Infinite Saturation Flow			Inf	Inf
J1:6/1				Infinite Saturation Flow			Inf	Inf
J1:6/2				Infinite Saturation Flow			Inf	Inf
J1:7/1				Infinite Saturation Flow			Inf	Inf
J1:8/1				Infinite Saturation Flow			Inf	Inf
J1:8/2				Infinite Saturation Flow			Inf	Inf

Junction: J2: Macclesfield Rd / Dean Lane								
Lane	Lane Width (m)	Gradient	Nearside Lane	Allowed Turns	Turning Radius (m)	Turning Prop.	Sat Flow (PCU/Hr)	Flared Sat Flow (PCU/Hr)
J2:1/1	3.00	0.00	Y	Arm J2:6 Ahead Arm J2:8 Left	Inf 10.00	44.5 % 55.5 %	1768	1768
J2:1/2	3.00	0.00	N	Arm J2:6 Ahead Arm J2:7 Right	Inf 12.00	87.1 % 12.9 %	2022	2022
J2:2/1	Infinite Saturation Flow						Inf	Inf
J2:3/1	3.80	0.00	Y	Arm J2:2 Right Arm J2:6 Left Arm J2:7 Ahead Arm J2:2 Left	12.00 24.00 Inf 12.00	85.0 % 15.0 % 0.0 % 35.7 %	1788	1788
J2:4/1	3.09	0.00	Y	Arm J2:6 Right Arm J2:8 Ahead	12.00 Inf	64.3 % 0.0 %	1710	1710
J2:5/1	3.05	0.00	Y	Arm J2:2 Ahead Arm J2:7 Left	Inf 12.00	87.5 % 12.5 %	1890	1890
J2:5/2	3.05	0.00	N	Arm J2:8 Right	12.00	100.0 %	1831	1831
J2:6/1	Infinite Saturation Flow						Inf	Inf
J2:6/2	Infinite Saturation Flow						Inf	Inf
J2:7/1	Infinite Saturation Flow						Inf	Inf
J2:8/1	Infinite Saturation Flow						Inf	Inf

Scenario 1: 'AM 2017' (FG2: 'am 2017', Plan 2: 'Network Control Plan 2')

C1

Stage Sequence Diagram

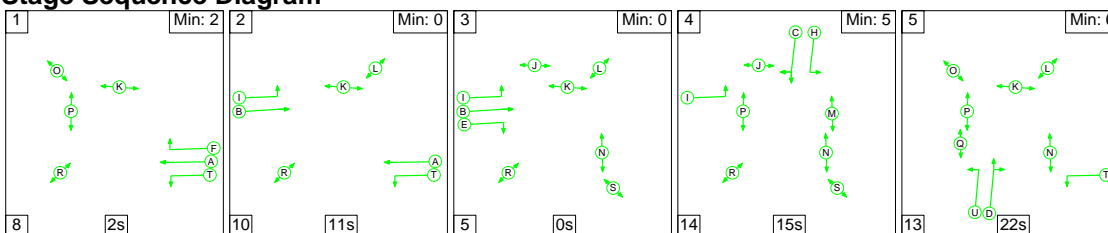

Stage Timings

Stage	1	2	3	4	5
Duration	2	11	0	15	22
Change Point	4	14	35	40	69

Signal Timings Diagram

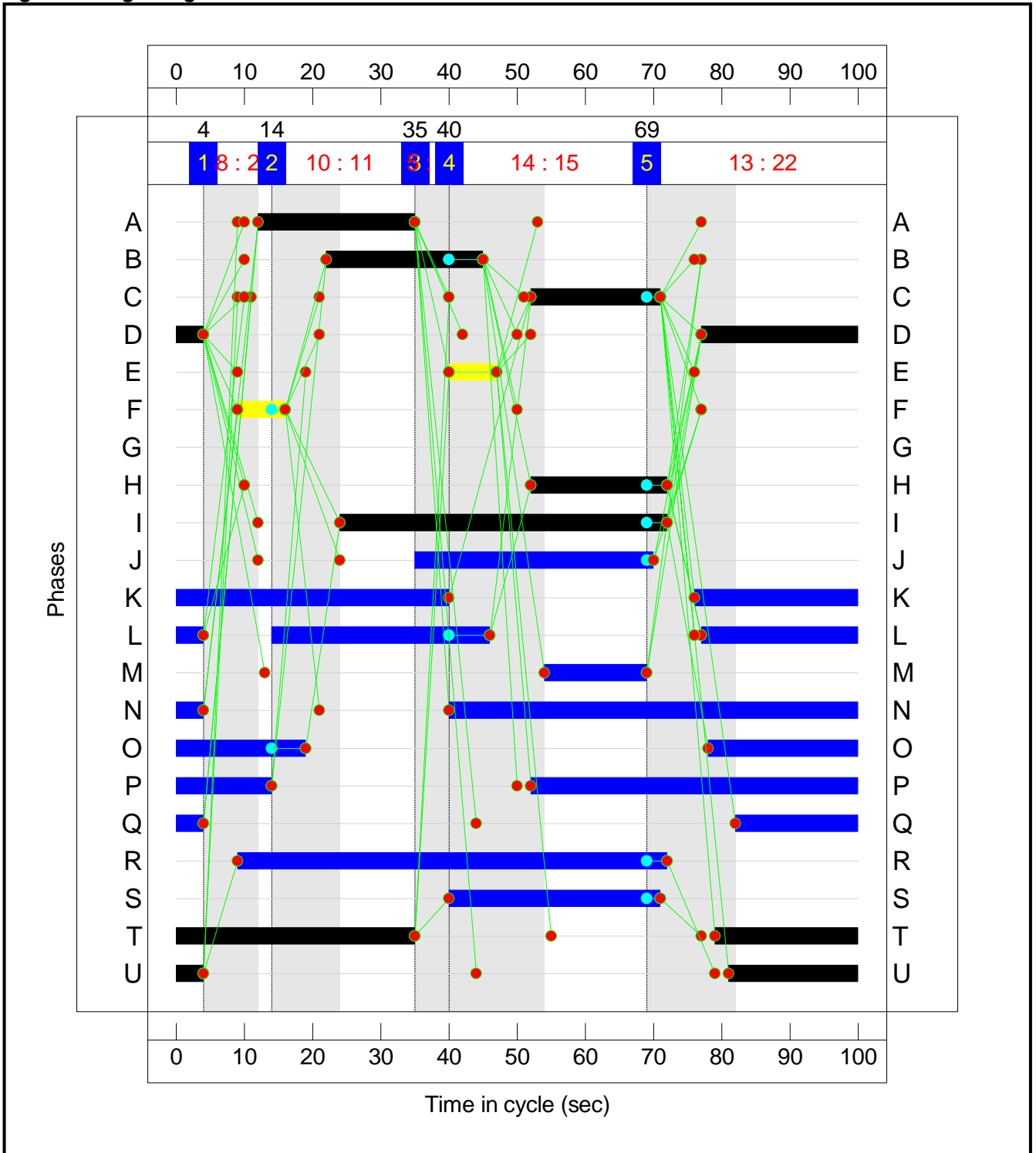

C2
Stage Sequence Diagram
Stage Stream: 1

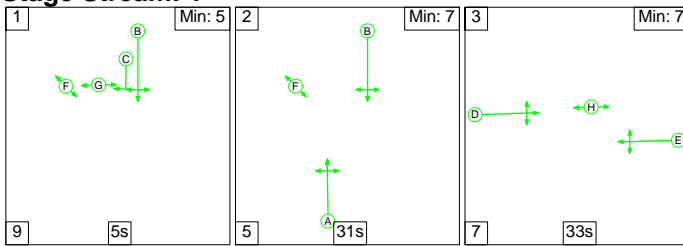

Stage Timings
Stage Stream: 1

Stage	1	2	3
Duration	5	31	33
Change Point	4	18	54

Signal Timings Diagram

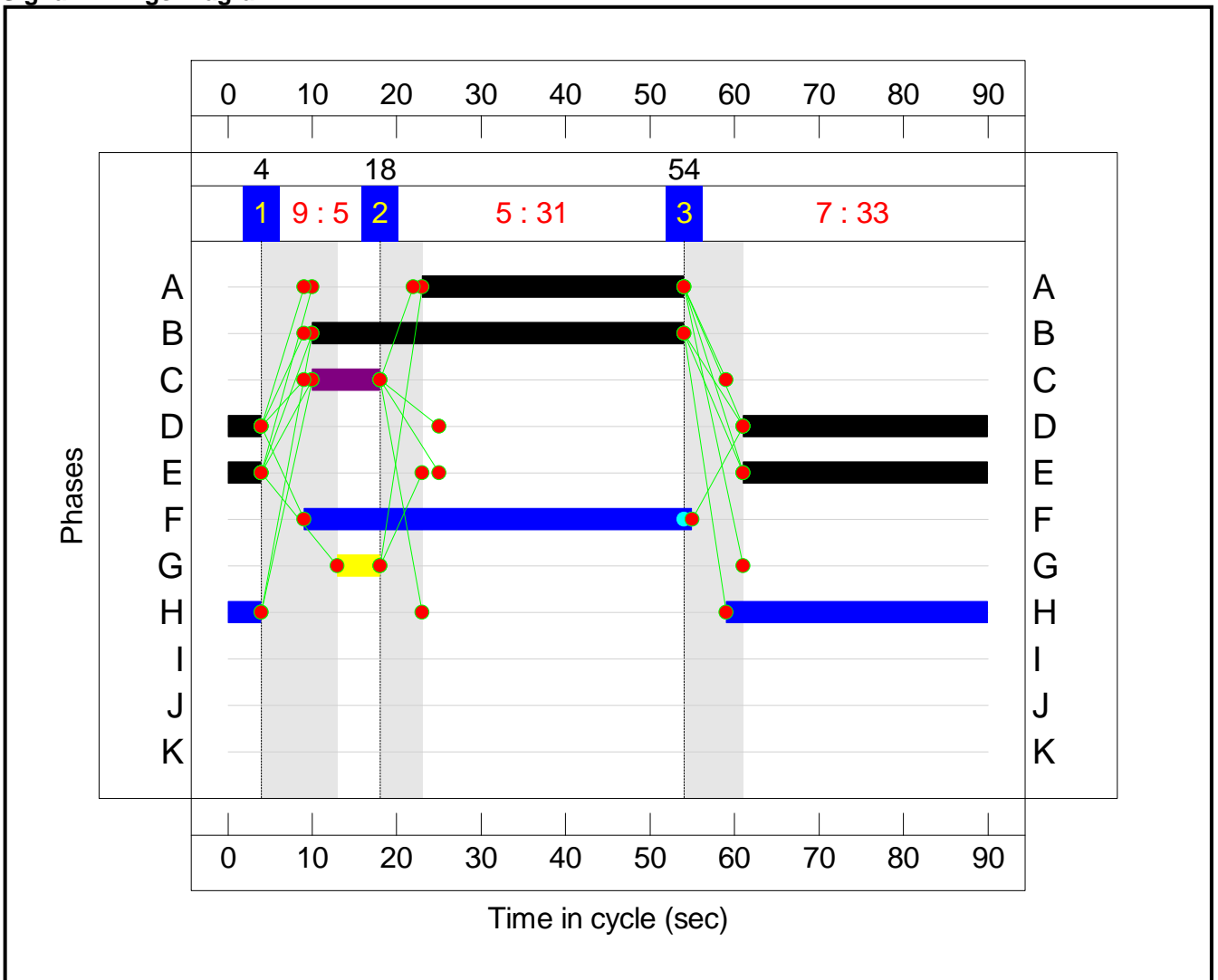

Network Layout Diagram

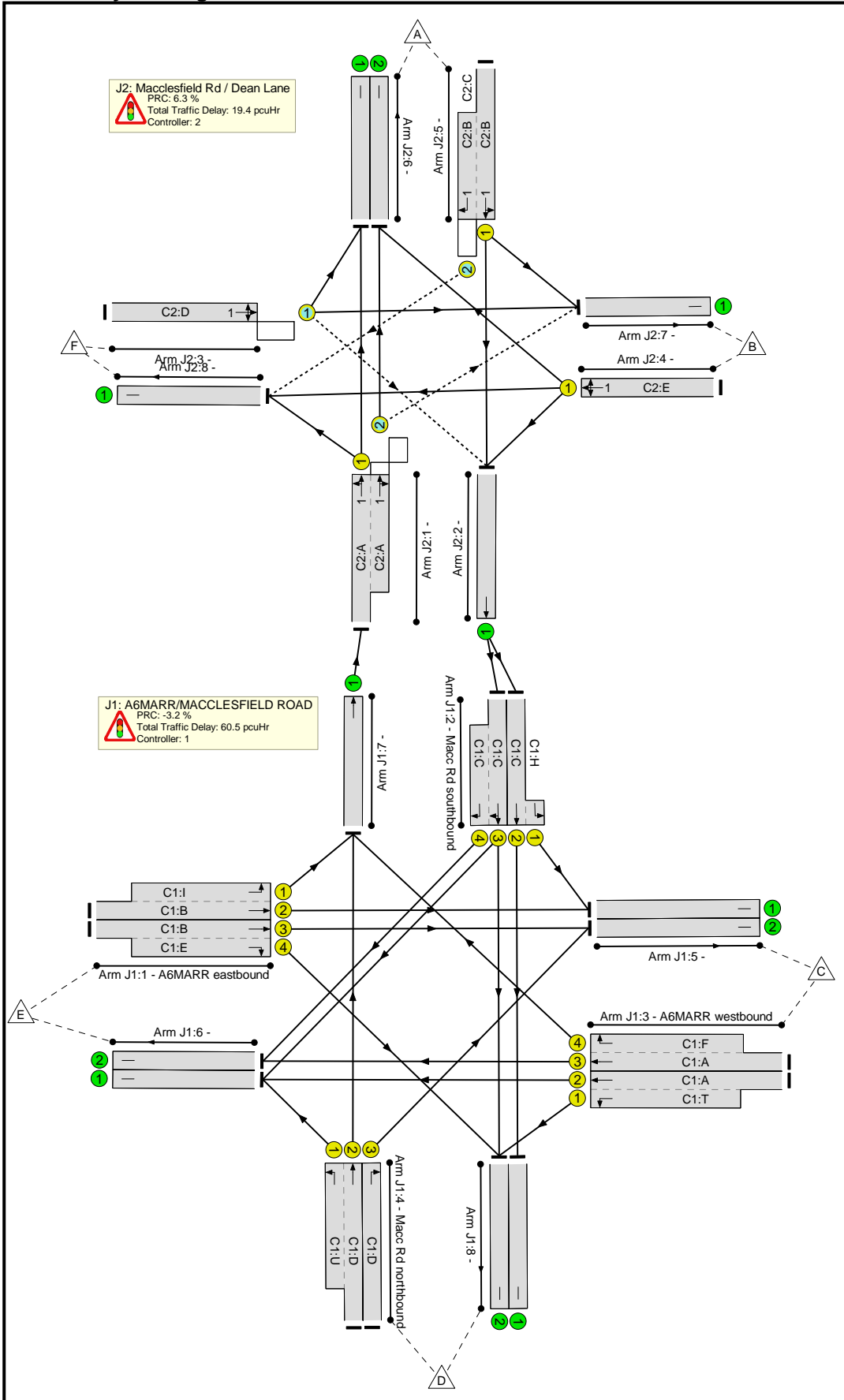

Network Results

Item	Lane Description	Lane Type	Controller Stream	Position In Filtered Route	Full Phase	Arrow Phase	Num Greens	Total Green (s)	Arrow Green (s)	Demand Flow (pcu)	Sat Flow (pcu/Hr)	Capacity (pcu)	Deg Sat (%)
Network: A6MARR / Macclesfield Road / Fiveways	-	-	N/A	-	-		-	-	-	-	-	-	92.9%
J1: A6MARR/MACCLESFIELD ROAD	-	-	N/A	-	-		-	-	-	-	-	-	92.9%
1/2+1/1	A6MARR eastbound Ahead Left	U	N/A	N/A	C1:B C1:I		1	23:48	-	806	2120:1956	1079	74.7%
1/3+1/4	A6MARR eastbound Ahead Right	U	N/A	N/A	C1:B C1:E		1	23:7	-	428	2120:1819	589	72.7%
2/2+2/1	Macc Rd southbound Left Ahead	U	N/A	N/A	C1:C C1:H		1	19:20	-	396	1980:1956	449	88.2%
2/3+2/4	Macc Rd southbound Right Ahead	U	N/A	N/A	C1:C		1	19	-	706	2120:1972	760	92.9%
3/2+3/1	A6MARR westbound Ahead Left	U	N/A	N/A	C1:A C1:T		1	23:56	-	557	2120:1927	620	89.9%
3/3+3/4	A6MARR westbound Ahead Right	U	N/A	N/A	C1:A C1:F		1	23:7	-	568	2120:1819	651	87.3%
4/2+4/1	Macc Rd northbound Left Ahead	U	N/A	N/A	C1:D C1:U		1	27:23	-	683	2120:1957	871	78.4%
4/3	Macc Rd northbound Right	U	N/A	N/A	C1:D		1	27	-	137	1979	554	24.7%
5/1		U	N/A	N/A	-		-	-	-	563	Inf	Inf	0.0%
5/2		U	N/A	N/A	-		-	-	-	506	Inf	Inf	0.0%
6/1		U	N/A	N/A	-		-	-	-	824	Inf	Inf	0.0%

Item	Lane Description	Lane Type	Controller Stream	Position In Filtered Route	Full Phase	Arrow Phase	Num Greens	Total Green (s)	Arrow Green (s)	Demand Flow (pcu)	Sat Flow (pcu/Hr)	Capacity (pcu)	Deg Sat (%)
6/2		U	N/A	N/A	-		-	-	-	793	Inf	Inf	0.0%
7/1	Ahead	U	N/A	N/A	-		-	-	-	964	Inf	Inf	0.0%
8/1		U	N/A	N/A	-		-	-	-	213	Inf	Inf	0.0%
8/2		U	N/A	N/A	-		-	-	-	418	Inf	Inf	0.0%
J2: Macclesfield Rd / Dean Lane	-	-	N/A	-	-		-	-	-	-	-	-	84.7%
1/1+1/2	Ahead Right Left	U+O	2:1	N/A	C2:A		1	31	-	964	1721:2037	1321	73.0%
2/1	Ahead	U	N/A	N/A	-		-	-	-	1102	Inf	Inf	0.0%
3/1	Right Left Ahead	O	2:1	N/A	C2:D		1	33	-	474	1778	560	84.7%
4/1	Left Right Ahead	U	2:1	N/A	C2:E		1	33	-	145	1710	646	22.4%
5/1+5/2	Ahead Left Right	U+O	2:1	N/A	C2:B	C2:C	1	44	8	654	1901:1831	991	66.0%
6/1		U	N/A	N/A	-		-	-	-	130	Inf	Inf	0.0%
6/2		U	N/A	N/A	-		-	-	-	543	Inf	Inf	0.0%
7/1		U	N/A	N/A	-		-	-	-	84	Inf	Inf	0.0%
8/1		U	N/A	N/A	-		-	-	-	378	Inf	Inf	0.0%

Item	Arriving (pcu)	Leaving (pcu)	Turners In Gaps (pcu)	Turners When Unopposed (pcu)	Turners In Intergreen (pcu)	Uniform Delay (pcuHr)	Rand + Oversat Delay (pcuHr)	Storage Area Uniform Delay (pcuHr)	Total Delay (pcuHr)	Av. Delay Per PCU (s/pcu)	Max. Back of Uniform Queue (pcu)	Rand + Oversat Queue (pcu)	Mean Max Queue (pcu)
Network: A6MARR / Macclesfield Road / Fiveways	-	-	500	26	8	53.7	25.7	0.6	79.9	-	-	-	-
J1: A6MARR/MACCLESFIELD ROAD	-	-	0	0	0	39.9	20.6	0.0	60.5	-	-	-	-
1/2+1/1	806	806	-	-	-	5.7	1.5	-	7.1	31.9	9.7	1.5	11.2
1/3+1/4	428	428	-	-	-	4.3	1.3	-	5.6	47.2	9.4	1.3	10.7
2/2+2/1	396	396	-	-	-	4.1	3.3	-	7.4	67.5	8.8	3.3	12.2
2/3+2/4	706	706	-	-	-	7.6	5.4	-	13.0	66.4	9.8	5.4	15.2
3/2+3/1	557	557	-	-	-	4.9	3.9	-	8.8	57.2	12.1	3.9	16.0
3/3+3/4	568	568	-	-	-	6.1	3.2	-	9.3	58.6	12.1	3.2	15.3
4/2+4/1	683	683	-	-	-	6.2	1.8	-	8.0	42.1	10.5	1.8	12.2
4/3	137	137	-	-	-	1.1	0.2	-	1.2	32.2	2.9	0.2	3.1
5/1	563	563	-	-	-	0.0	0.0	-	0.0	0.0	0.0	0.0	0.0
5/2	506	506	-	-	-	0.0	0.0	-	0.0	0.0	0.0	0.0	0.0
6/1	824	824	-	-	-	0.0	0.0	-	0.0	0.0	0.0	0.0	0.0
6/2	793	793	-	-	-	0.0	0.0	-	0.0	0.0	0.0	0.0	0.0
7/1	964	964	-	-	-	0.0	0.0	-	0.0	0.0	0.0	0.0	0.0
8/1	213	213	-	-	-	0.0	0.0	-	0.0	0.0	0.0	0.0	0.0
8/2	418	418	-	-	-	0.0	0.0	-	0.0	0.0	0.0	0.0	0.0
J2: Macclesfield Rd / Dean Lane	-	-	500	26	8	13.7	5.1	0.6	19.4	-	-	-	-
1/1+1/2	964	964	36	0	0	6.7	1.3	0.0	8.1	30.3	11.3	1.3	12.6
2/1	1102	1102	-	-	-	0.0	0.0	-	0.0	0.0	0.0	0.0	0.0

Item	Arriving (pcu)	Leaving (pcu)	Turners In Gaps (pcu)	Turners When Unopposed (pcu)	Turners In Intergreen (pcu)	Uniform Delay (pcuHr)	Rand + Oversat Delay (pcuHr)	Storage Area Uniform Delay (pcuHr)	Total Delay (pcuHr)	Av. Delay Per PCU (s/pcu)	Max. Back of Uniform Queue (pcu)	Rand + Oversat Queue (pcu)	Mean Max Queue (pcu)																					
3/1	474	474	447	0	7	3.3	2.6	0.6	6.4	48.9	10.7	2.6	13.3																					
4/1	145	145	-	-	-	0.8	0.1	-	0.9	22.6	2.5	0.1	2.6																					
5/1+5/2	654	654	18	26	0	3.0	1.0	0.0	4.0	21.9	11.2	1.0	12.1																					
6/1	130	130	-	-	-	0.0	0.0	-	0.0	0.0	0.0	0.0	0.0																					
6/2	543	543	-	-	-	0.0	0.0	-	0.0	0.0	0.0	0.0	0.0																					
7/1	84	84	-	-	-	0.0	0.0	-	0.0	0.0	0.0	0.0	0.0																					
8/1	378	378	-	-	-	0.0	0.0	-	0.0	0.0	0.0	0.0	0.0																					
<table border="0" style="width: 100%;"> <tr> <td style="width: 15%;">C1</td> <td style="width: 25%;">PRC for Signalled Lanes (%):</td> <td style="width: 15%;">-3.2</td> <td style="width: 20%;">Total Delay for Signalled Lanes (pcuHr):</td> <td style="width: 15%;">60.51</td> <td style="width: 10%;">Cycle Time (s):</td> <td style="width: 10%;">100</td> </tr> <tr> <td>C2</td> <td>Stream: 1 PRC for Signalled Lanes (%):</td> <td>6.3</td> <td>Total Delay for Signalled Lanes (pcuHr):</td> <td>19.42</td> <td>Cycle Time (s):</td> <td>90</td> </tr> <tr> <td></td> <td>PRC Over All Lanes (%):</td> <td>-3.2</td> <td>Total Delay Over All Lanes (pcuHr):</td> <td>79.93</td> <td></td> <td></td> </tr> </table>														C1	PRC for Signalled Lanes (%):	-3.2	Total Delay for Signalled Lanes (pcuHr):	60.51	Cycle Time (s):	100	C2	Stream: 1 PRC for Signalled Lanes (%):	6.3	Total Delay for Signalled Lanes (pcuHr):	19.42	Cycle Time (s):	90		PRC Over All Lanes (%):	-3.2	Total Delay Over All Lanes (pcuHr):	79.93		
C1	PRC for Signalled Lanes (%):	-3.2	Total Delay for Signalled Lanes (pcuHr):	60.51	Cycle Time (s):	100																												
C2	Stream: 1 PRC for Signalled Lanes (%):	6.3	Total Delay for Signalled Lanes (pcuHr):	19.42	Cycle Time (s):	90																												
	PRC Over All Lanes (%):	-3.2	Total Delay Over All Lanes (pcuHr):	79.93																														

Scenario 2: 'PM 2017' (FG3: 'pm 2017', Plan 2: 'Network Control Plan 2')

C1

Stage Sequence Diagram

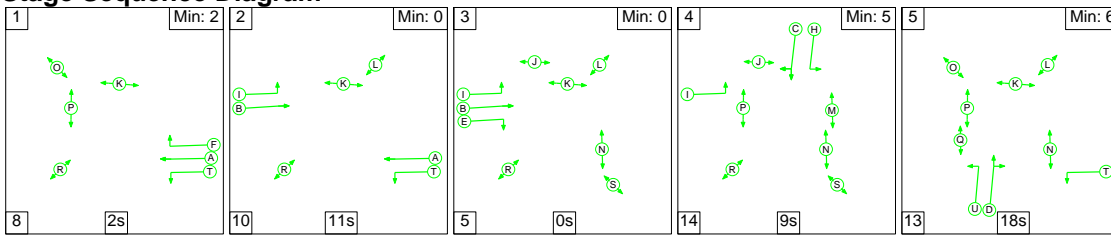

Stage Timings

Stage	1	2	3	4	5
Duration	2	11	0	9	18
Change Point	10	20	41	46	69

Signal Timings Diagram

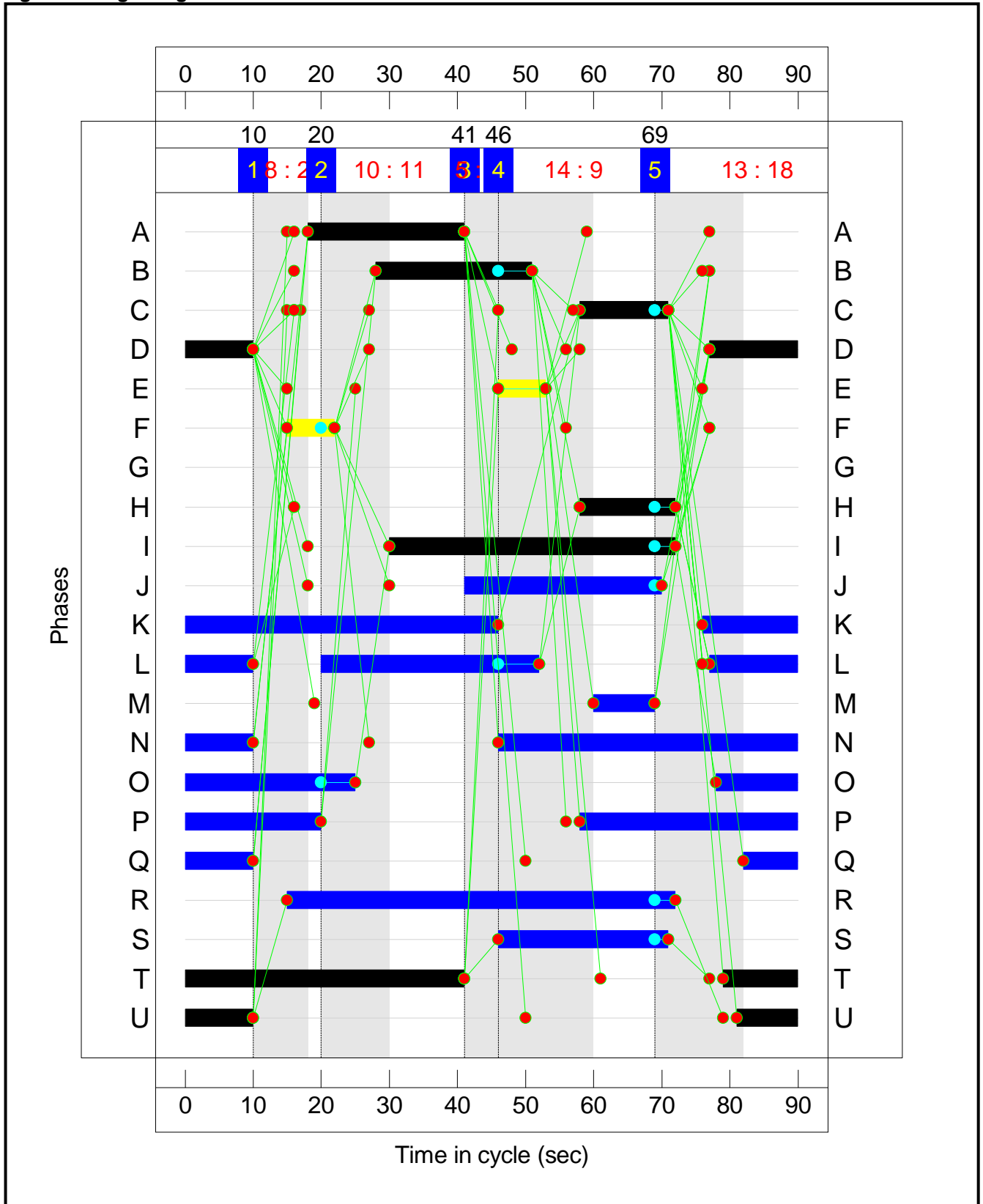

C2
Stage Sequence Diagram
Stage Stream: 1

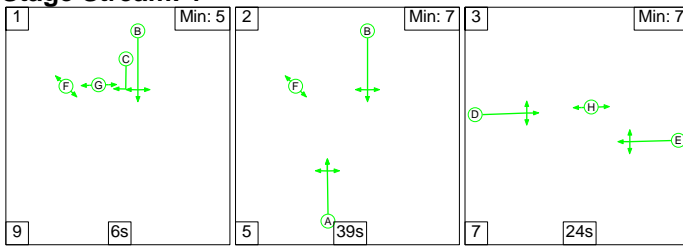

Stage Timings
Stage Stream: 1

Stage	1	2	3
Duration	6	39	24
Change Point	31	46	0

Signal Timings Diagram

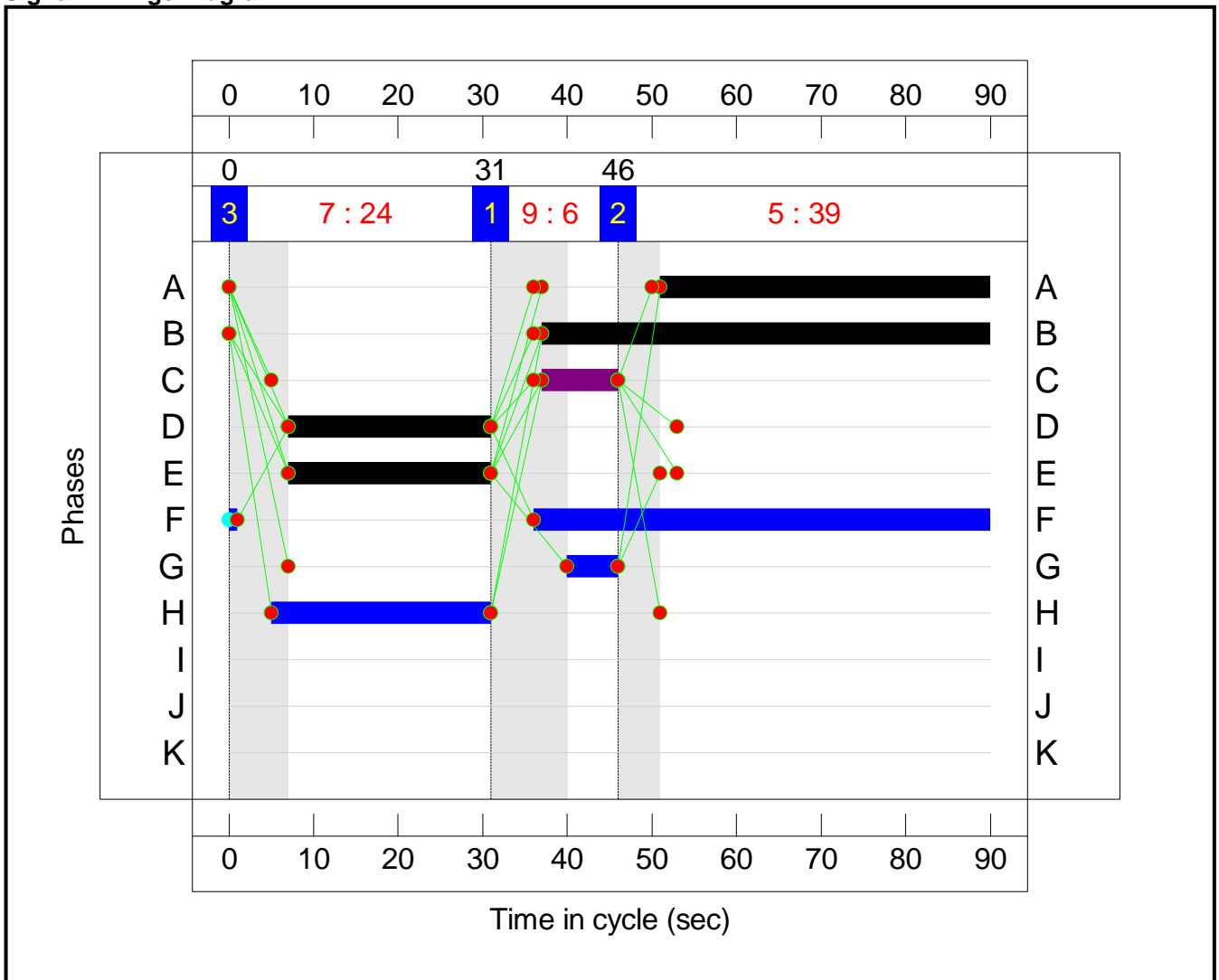

Network Layout Diagram

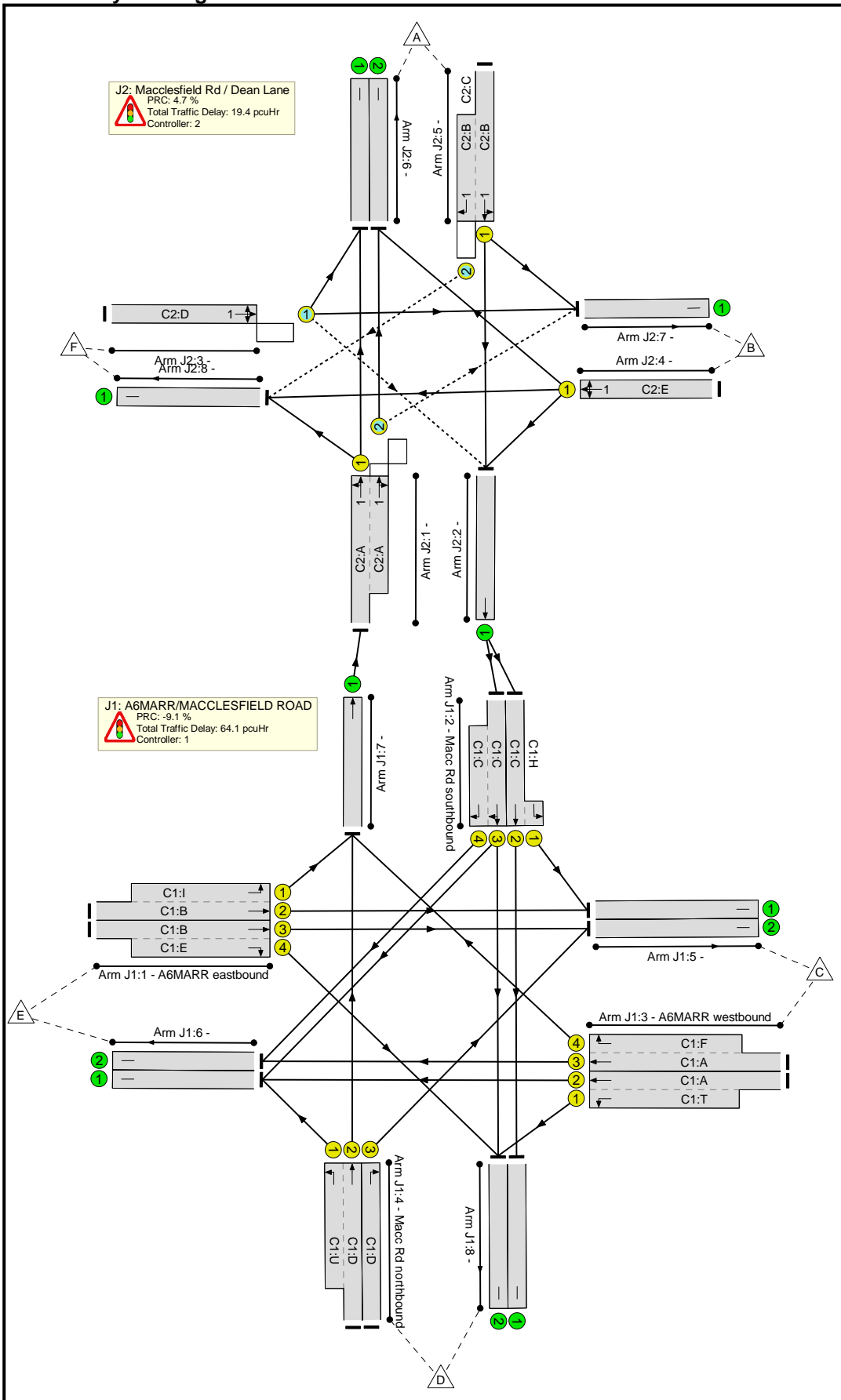

Network Results

Item	Lane Description	Lane Type	Controller Stream	Position In Filtered Route	Full Phase	Arrow Phase	Num Greens	Total Green (s)	Arrow Green (s)	Demand Flow (pcu)	Sat Flow (pcu/Hr)	Capacity (pcu)	Deg Sat (%)
Network: A6MARR / Macclesfield Road / Fiveways	-	-	N/A	-	-		-	-	-	-	-	-	98.2%
J1: A6MARR/MACCLESFIELD ROAD	-	-	N/A	-	-		-	-	-	-	-	-	98.2%
1/2+1/1	A6MARR eastbound Ahead Left	U	N/A	N/A	C1:B C1:I		1	23:42	-	1215	2120:1956	1371	88.6%
1/3+1/4	A6MARR eastbound Ahead Right	U	N/A	N/A	C1:B C1:E		1	23:7	-	675	2120:1819	706	95.6%
2/2+2/1	Macc Rd southbound Left Ahead	U	N/A	N/A	C1:C C1:H		1	13:14	-	308	1980:1956	328	93.8%
2/3+2/4	Macc Rd southbound Right Ahead	U	N/A	N/A	C1:C		1	13	-	625	2120:1972	637	98.2%
3/2+3/1	A6MARR westbound Ahead Left	U	N/A	N/A	C1:A C1:T		1	23:52	-	443	2120:1927	681	65.1%
3/3+3/4	A6MARR westbound Ahead Right	U	N/A	N/A	C1:A C1:F		1	23:7	-	431	2120:1819	669	64.4%
4/2+4/1	Macc Rd northbound Left Ahead	U	N/A	N/A	C1:D C1:U		1	23:19	-	500	2120:1957	634	78.9%
4/3	Macc Rd northbound Right	U	N/A	N/A	C1:D		1	23	-	182	1979	528	34.5%
5/1		U	N/A	N/A	-		-	-	-	469	Inf	Inf	0.0%
5/2		U	N/A	N/A	-		-	-	-	721	Inf	Inf	0.0%
6/1		U	N/A	N/A	-		-	-	-	454	Inf	Inf	0.0%

Item	Lane Description	Lane Type	Controller Stream	Position In Filtered Route	Full Phase	Arrow Phase	Num Greens	Total Green (s)	Arrow Green (s)	Demand Flow (pcu)	Sat Flow (pcu/Hr)	Capacity (pcu)	Deg Sat (%)
6/2		U	N/A	N/A	-		-	-	-	664	Inf	Inf	0.0%
7/1	Ahead	U	N/A	N/A	-		-	-	-	1342	Inf	Inf	0.0%
8/1		U	N/A	N/A	-		-	-	-	226	Inf	Inf	0.0%
8/2		U	N/A	N/A	-		-	-	-	503	Inf	Inf	0.0%
J2: Macclesfield Rd / Dean Lane	-	-	N/A	-	-		-	-	-	-	-	-	86.0%
1/1+1/2	Ahead Right Left	U+O	2:1	N/A	C2:A		1	39	-	1342	1768:2022	1564	85.8%
2/1	Ahead	U	N/A	N/A	-		-	-	-	933	Inf	Inf	0.0%
3/1	Right Left Ahead	O	2:1	N/A	C2:D		1	24	-	427	1788	497	86.0%
4/1	Left Right Ahead	U	2:1	N/A	C2:E		1	24	-	70	1710	475	14.7%
5/1+5/2	Ahead Left Right	U+O	2:1	N/A	C2:B	C2:C	1	53	9	646	1890:1831	1164	55.5%
6/1		U	N/A	N/A	-		-	-	-	365	Inf	Inf	0.0%
6/2		U	N/A	N/A	-		-	-	-	625	Inf	Inf	0.0%
7/1		U	N/A	N/A	-		-	-	-	164	Inf	Inf	0.0%
8/1		U	N/A	N/A	-		-	-	-	398	Inf	Inf	0.0%

Item	Arriving (pcu)	Leaving (pcu)	Turners In Gaps (pcu)	Turners When Unopposed (pcu)	Turners In Intergreen (pcu)	Uniform Delay (pcuHr)	Rand + Oversat Delay (pcuHr)	Storage Area Uniform Delay (pcuHr)	Total Delay (pcuHr)	Av. Delay Per PCU (s/pcu)	Max. Back of Uniform Queue (pcu)	Rand + Oversat Queue (pcu)	Mean Max Queue (pcu)
Network: A6MARR / Macclesfield Road / Fiveways	-	-	455	12	5	46.9	36.4	0.2	83.6	-	-	-	-
J1: A6MARR/MACCLESFIELD ROAD	-	-	0	0	0	34.2	30.0	0.0	64.1	-	-	-	-
1/2+1/1	1215	1215	-	-	-	8.1	3.7	-	11.8	34.9	18.6	3.7	22.3
1/3+1/4	675	675	-	-	-	6.4	7.3	-	13.7	73.2	13.2	7.3	20.5
2/2+2/1	308	308	-	-	-	2.4	5.1	-	7.4	87.0	6.7	5.1	11.8
2/3+2/4	625	625	-	-	-	4.9	9.9	-	14.9	85.8	8.0	9.9	17.9
3/2+3/1	443	443	-	-	-	3.1	0.9	-	4.1	33.0	8.0	0.9	8.9
3/3+3/4	431	431	-	-	-	3.7	0.9	-	4.6	38.2	8.0	0.9	8.9
4/2+4/1	500	500	-	-	-	4.2	1.8	-	6.0	43.5	10.3	1.8	12.1
4/3	182	182	-	-	-	1.3	0.3	-	1.6	31.9	3.6	0.3	3.9
5/1	469	469	-	-	-	0.0	0.0	-	0.0	0.0	0.0	0.0	0.0
5/2	721	721	-	-	-	0.0	0.0	-	0.0	0.0	0.0	0.0	0.0
6/1	454	454	-	-	-	0.0	0.0	-	0.0	0.0	0.0	0.0	0.0
6/2	664	664	-	-	-	0.0	0.0	-	0.0	0.0	0.0	0.0	0.0
7/1	1342	1342	-	-	-	0.0	0.0	-	0.0	0.0	0.0	0.0	0.0
8/1	226	226	-	-	-	0.0	0.0	-	0.0	0.0	0.0	0.0	0.0
8/2	503	503	-	-	-	0.0	0.0	-	0.0	0.0	0.0	0.0	0.0
J2: Macclesfield Rd / Dean Lane	-	-	455	12	5	12.7	6.5	0.2	19.4	-	-	-	-
1/1+1/2	1342	1342	85	0	1	6.7	2.9	0.0	9.6	25.9	31.1	2.9	34.1
2/1	933	933	-	-	-	0.0	0.0	-	0.0	0.0	0.0	0.0	0.0

Item	Arriving (pcu)	Leaving (pcu)	Turners In Gaps (pcu)	Turners When Unopposed (pcu)	Turners In Intergreen (pcu)	Uniform Delay (pcuHr)	Rand + Oversat Delay (pcuHr)	Storage Area Uniform Delay (pcuHr)	Total Delay (pcuHr)	Av. Delay Per PCU (s/pcu)	Max. Back of Uniform Queue (pcu)	Rand + Oversat Queue (pcu)	Mean Max Queue (pcu)
3/1	427	427	359	0	4	3.7	2.8	0.2	6.6	56.0	10.1	2.8	12.9
4/1	70	70	-	-	-	0.5	0.1	-	0.6	28.9	1.3	0.1	1.4
5/1+5/2	646	646	11	12	0	1.9	0.6	0.1	2.6	14.4	9.2	0.6	9.8
6/1	365	365	-	-	-	0.0	0.0	-	0.0	0.0	0.0	0.0	0.0
6/2	625	625	-	-	-	0.0	0.0	-	0.0	0.0	0.0	0.0	0.0
7/1	164	164	-	-	-	0.0	0.0	-	0.0	0.0	0.0	0.0	0.0
8/1	398	398	-	-	-	0.0	0.0	-	0.0	0.0	0.0	0.0	0.0
C1			PRC for Signalled Lanes (%):		-9.1	Total Delay for Signalled Lanes (pcuHr):		64.14	Cycle Time (s):		90		
C2			Stream: 1 PRC for Signalled Lanes (%):		4.7	Total Delay for Signalled Lanes (pcuHr):		19.44	Cycle Time (s):		90		
			PRC Over All Lanes (%):		-9.1	Total Delay Over All Lanes (pcuHr):		83.58					

Appendix F.4

A6MARR/ Bramhall Oil Terminal Gyrotory & A6MARR Link Road/ A5149 Chester Road LinSig Output

A6MARR/ Bramhall Oil Terminal Gyratory & A6MARR Link Road/ A5149 Chester Road LinSig Output

Full Input Data And Results

User and Project Details

Project:	A6MARR
Title:	Oil Terminal Gyratory
Location:	
File name:	3 - A6MARR_Oil_Terminal_Gyratory.lsg3x
Author:	GDC
Company:	Atkins
Address:	Bank Chambers, Faulkner Street, Manchester
Notes:	

Network Layout Diagram

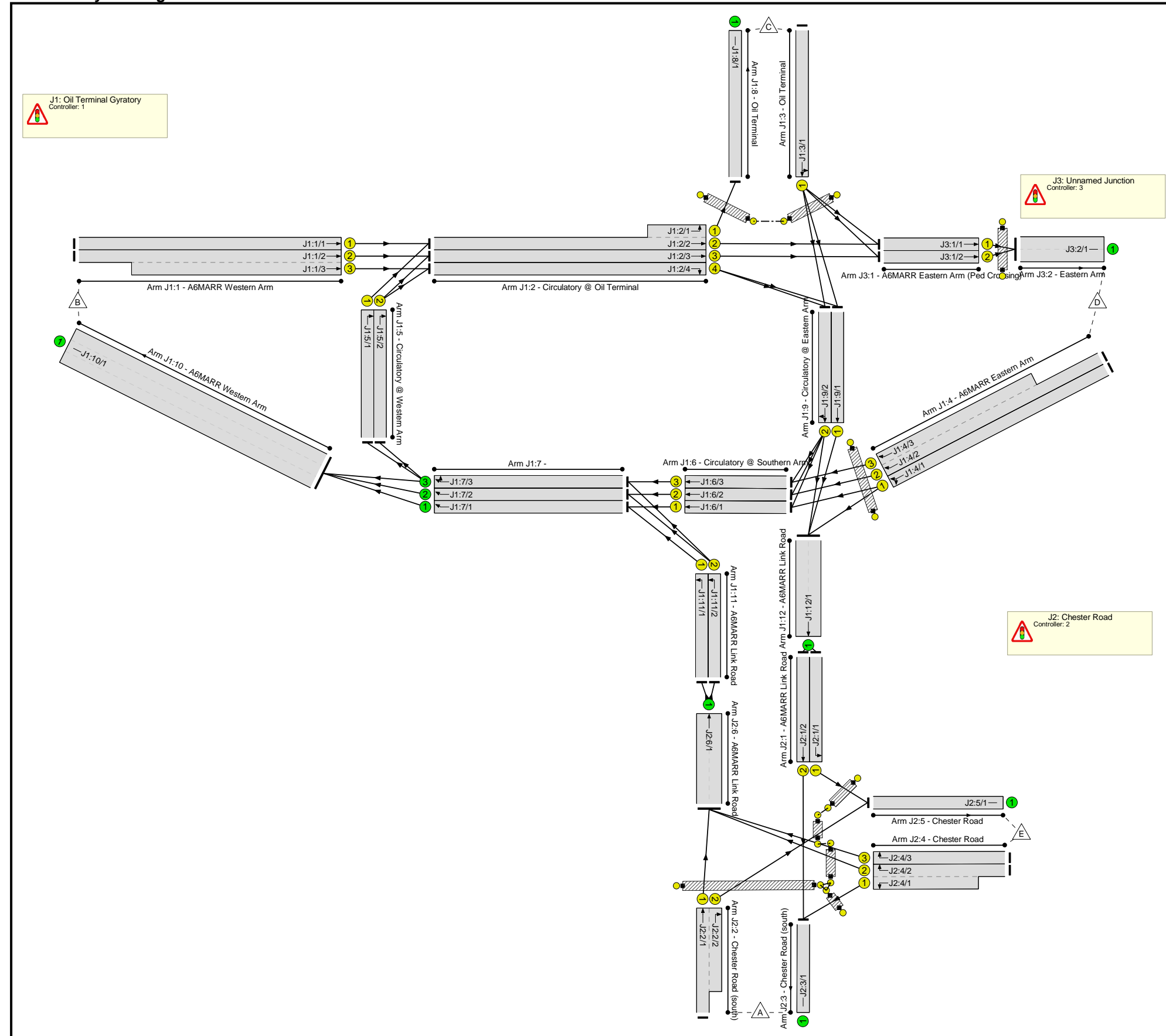

C1

Phase Diagram

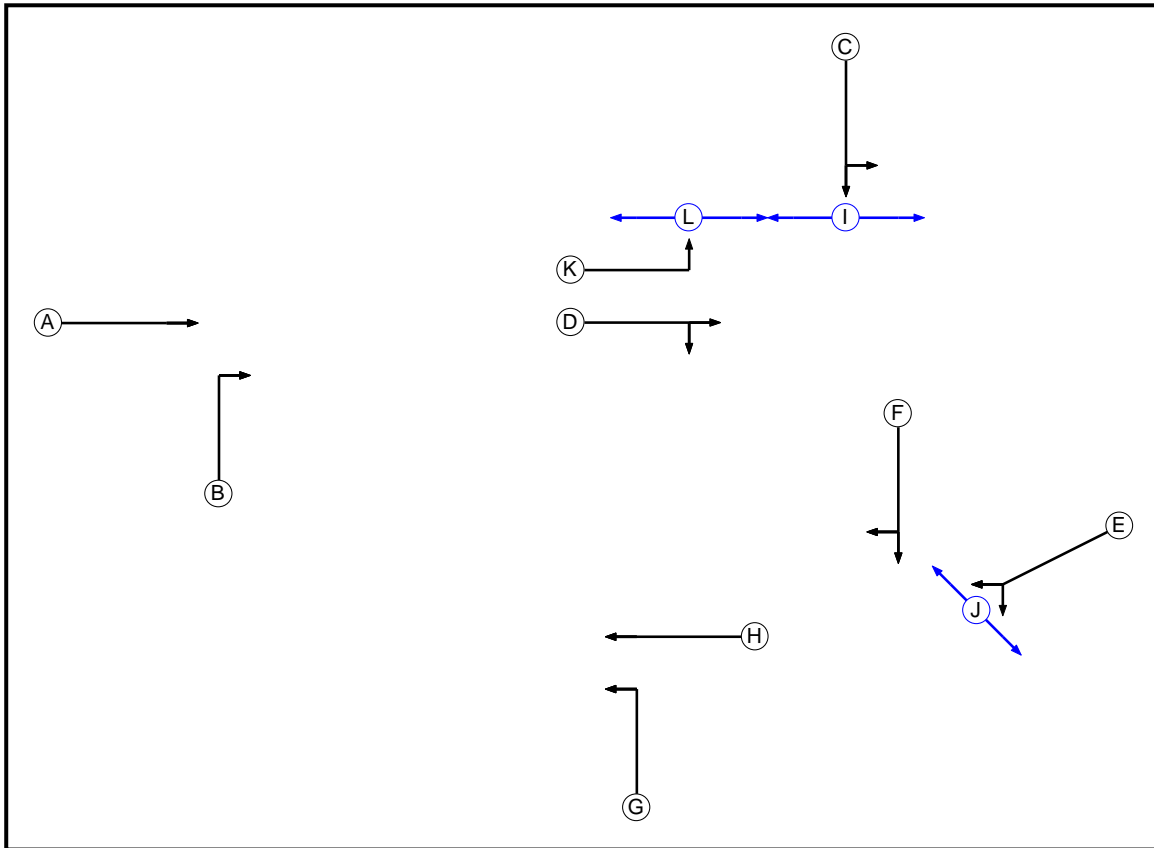

Phase Input Data

Phase Name	Phase Type	Stage	Stream	Assoc. Phase	Street Min	Cont Min
A	Traffic	1			7	7
B	Traffic	1			7	7
C	Traffic	2			7	7
D	Traffic	2			7	6
E	Traffic	3			7	7
F	Traffic	3			7	2
G	Traffic	4			7	7
H	Traffic	4			7	7
I	Pedestrian	2			5	5
J	Pedestrian	3			7	7
K	Traffic	5			7	7
L	Pedestrian	5			5	5

Phase Intergreens Matrix

		Starting Phase											
		A	B	C	D	E	F	G	H	I	J	K	L
Terminating Phase	A		5	-	-	-	-	-	-	-	-	-	-
	B	5		-	-	-	-	-	-	-	-	-	-
	C	-	-		5	-	-	-	-	5	-	-	-
	D	-	-	5		-	-	-	-	-	-	-	-
	E	-	-	-	-		6	-	-	-	5	-	-
	F	-	-	-	-	5		-	-	-	-	-	-
	G	-	-	-	-	-	-		5	-	-	-	-
	H	-	-	-	-	-	-	5		-	-	-	-
	I	-	-	7	-	-	-	-	-		-	-	-
	J	-	-	-	-	11	-	-	-	-		-	-
	K	-	-	-	-	-	-	-	-	-	-		5
	L	-	-	-	-	-	-	-	-	-	-	7	

Phases in Stage

Stream	Stage No.	Phases in Stage
1	1	A
1	2	B
2	1	C
2	2	D I
3	1	E
3	2	F J
4	1	G
4	2	H
5	1	K
5	2	L

Stage Diagram Stage Stream: 1

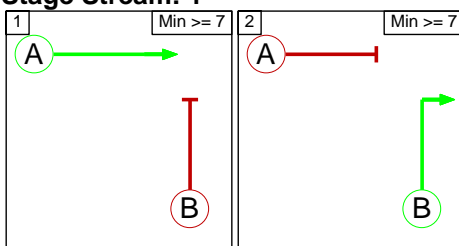

Stage Stream: 2

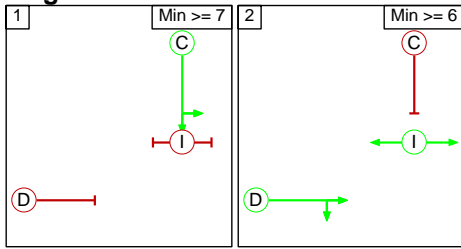

Stage Stream: 3

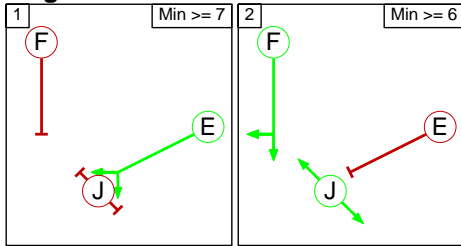

Stage Stream: 4

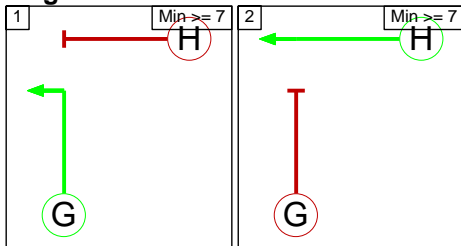

Stage Stream: 5

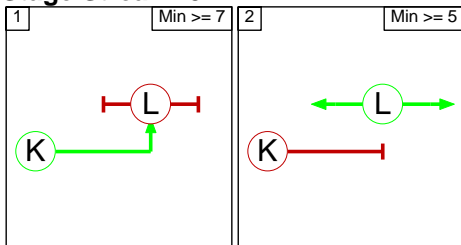

Phase Delays

Stage Stream: 1

Term. Stage	Start Stage	Phase	Type	Value	Cont value
There are no Phase Delays defined					

Stage Stream: 2

Term. Stage	Start Stage	Phase	Type	Value	Cont value
2	1	D	Losing	1	1

Stage Stream: 3

Term. Stage	Start Stage	Phase	Type	Value	Cont value
2	1	F	Losing	5	5

Stage Stream: 4

Term.	Stage	Start Stage	Phase	Type	Value	Cont value
There are no Phase Delays defined						

Stage Stream: 5

Term.	Stage	Start Stage	Phase	Type	Value	Cont value
There are no Phase Delays defined						

Prohibited Stage Change

Stage Stream: 1

		To Stage	
		1	2
From Stage	1		5
	2	5	

Stage Stream: 2

		To Stage	
		1	2
From Stage	1		5
	2	7	

Stage Stream: 3

		To Stage	
		1	2
From Stage	1		6
	2	11	

Stage Stream: 4

		To Stage	
		1	2
From Stage	1		5
	2	5	

Stage Stream: 5

		To Stage	
		1	2
From Stage	1		5
	2	7	

C2
Phase Diagram

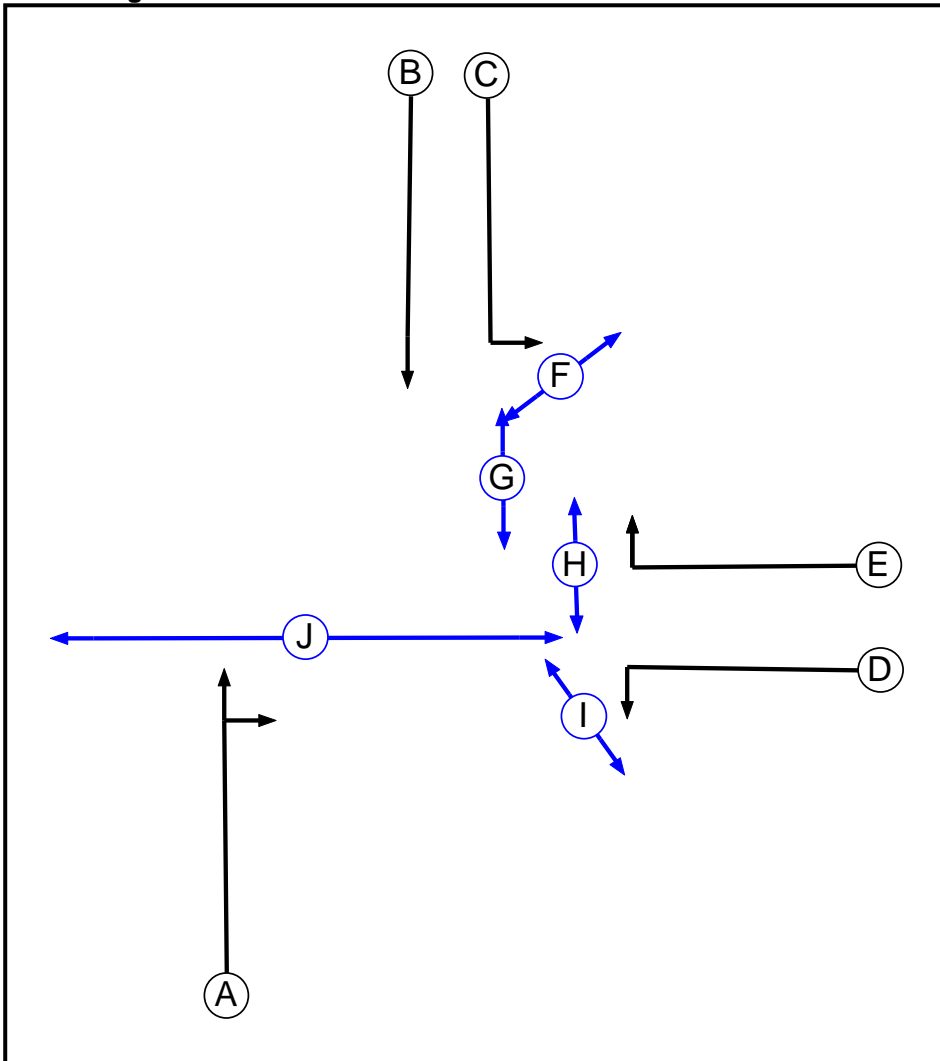

Phase Input Data

Phase Name	Phase Type	Assoc. Phase	Street Min	Cont Min
A	Traffic		-9999	7
B	Traffic		-9999	7
C	Traffic		-9999	7
D	Traffic		-9999	7
E	Traffic		-9999	7
F	Pedestrian		-9999	5
G	Pedestrian		-9999	5
H	Pedestrian		-9999	5
I	Pedestrian		-9999	5
J	Pedestrian		-9999	9

Phase Intergreens Matrix

		Starting Phase									
		A	B	C	D	E	F	G	H	I	J
Terminating Phase	A		5	7	-	6	-	8	-	-	5
	B	5		-	7	6	-	-	-	-	8
	C	5	-		-	-	5	-	-	-	-
	D	-	5	-		-	-	-	-	5	-
	E	6	5	-	-		-	-	5	-	-
	F	-	-	7	-	-		-	-	-	-
	G	7	-	-	-	-	-		-	-	-
	H	-	-	-	-	8	-	-		-	-
	I	-	-	-	7	-	-	-	-		-
	J	13	13	-	-	-	-	-	-	-	

Phases in Stage

Stage No.	Phases in Stage
1	A D F H
2	B C G H I
3	C D E G J

Stage Diagram

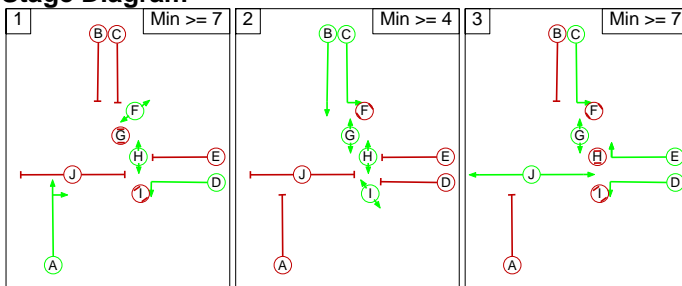

Phase Delays

Term. Stage	Start Stage	Phase	Type	Value	Cont value
3	1	C	Losing	8	8
3	1	E	Losing	7	7
3	1	G	Losing	6	6

Prohibited Stage Change

		To Stage		
		1	2	3
From Stage	1		8	8
	2	7		8
	3	13	13	

**C3
 Phase Diagram**

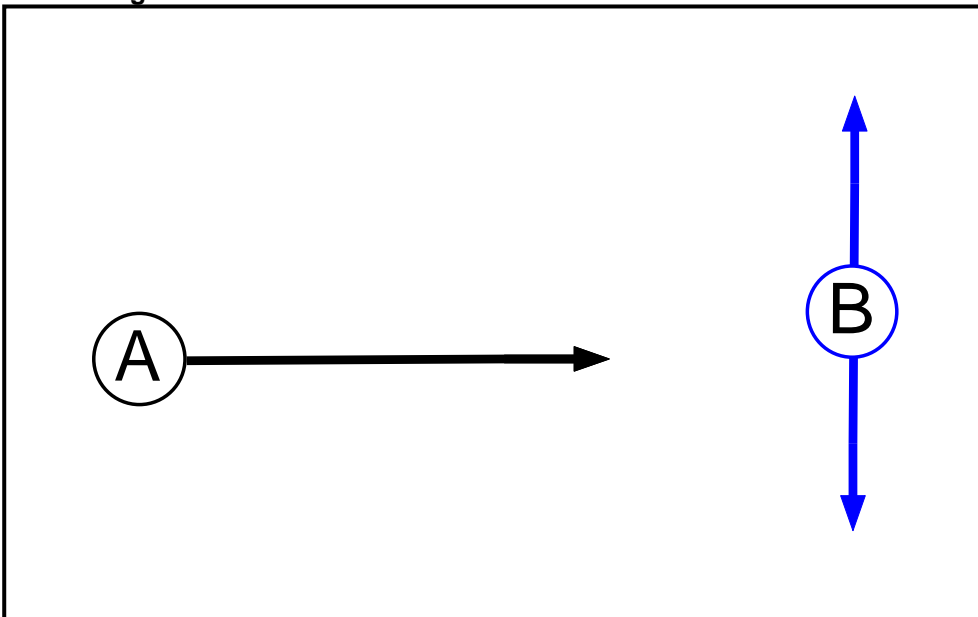

Phase Input Data

Phase Name	Phase Type	Assoc. Phase	Street Min	Cont Min
A	Traffic		7	7
B	Pedestrian		5	5

Phase Intergreens Matrix

		Starting Phase	
		A	B
Terminating Phase	A		5
	B	8	

Phases in Stage

Stage No.	Phases in Stage
1	A
2	B

Stage Diagram

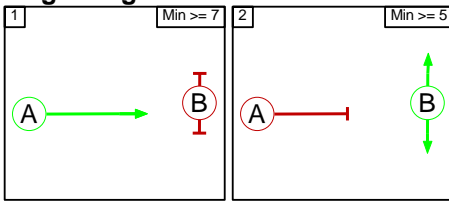

Phase Delays

Term.	Stage	Start Stage	Phase	Type	Value	Cont value
There are no Phase Delays defined						

Prohibited Stage Change

		To Stage	
		1	2
From Stage	1		5
	2	8	

Give-Way Lane Input Data

Junction: J1: Oil Terminal Gyratory
There are no Opposed Lanes in this Junction

Junction: J2: Chester Road
There are no Opposed Lanes in this Junction

Junction: J3: Unnamed Junction
There are no Opposed Lanes in this Junction

Lane Input Data

Junction: J1: Oil Terminal Gyratory												
Lane	Lane Type	Phases	Start Disp.	End Disp.	Physical Length (PCU)	Sat Flow Type	Def User Saturation Flow (PCU/Hr)	Lane Width (m)	Gradient	Nearside Lane	Turns	Turning Radius (m)
J1:1/1 (A6MARR Western Arm)	U	A	2	3	60.0	Geom	-	3.66	0.00	Y	Arm J1:2 Ahead	Inf
J1:1/2 (A6MARR Western Arm)	U	A	2	3	60.0	Geom	-	3.66	0.00	N	Arm J1:2 Ahead	Inf
J1:1/3 (A6MARR Western Arm)	U	A	2	3	31.3	Geom	-	3.66	0.00	Y	Arm J1:2 Ahead	Inf
J1:2/1 (Circulatory @ Oil Terminal)	U	K	2	3	7.0	Geom	-	5.00	0.00	Y	Arm J1:8 Left	20.00
J1:2/2 (Circulatory @ Oil Terminal)	U	D	2	3	33.9	Geom	-	4.00	0.00	Y	Arm J3:1 Ahead	Inf
J1:2/3 (Circulatory @ Oil Terminal)	U	D	2	3	33.9	Geom	-	4.00	0.00	Y	Arm J3:1 Ahead	Inf
J1:2/4 (Circulatory @ Oil Terminal)	U	D	2	3	33.9	Geom	-	4.00	0.00	N	Arm J1:9 Right	Inf
J1:3/1 (Oil Terminal)	U	C	2	3	60.0	Geom	-	5.00	0.00	Y	Arm J1:9 Ahead Arm J3:1 Left	20.00 20.00
J1:4/1 (A6MARR Eastern Arm)	U	E	2	3	60.0	Geom	-	3.66	0.00	Y	Arm J1:6 Ahead Arm J1:12 Left	Inf Inf
J1:4/2 (A6MARR Eastern Arm)	U	E	2	3	60.0	Geom	-	3.66	0.00	N	Arm J1:6 Ahead	Inf
J1:4/3 (A6MARR Eastern Arm)	U	E	2	3	20.9	Geom	-	3.66	0.00	Y	Arm J1:6 Ahead	Inf

J1:5/1 (Circulatory @ Western Arm)	U	B	2	3	7.8	Geom	-	3.90	0.00	Y	Arm J1:2 Right	Inf
J1:5/2 (Circulatory @ Western Arm)	U	B	2	3	7.0	Geom	-	3.90	0.00	Y	Arm J1:2 Right	30.00
J1:6/1 (Circulatory @ Southern Arm)	U	H	2	3	14.8	Geom	-	4.00	0.00	Y	Arm J1:7 Ahead	Inf
J1:6/2 (Circulatory @ Southern Arm)	U	H	2	3	14.8	Geom	-	4.00	0.00	N	Arm J1:7 Ahead	Inf
J1:6/3 (Circulatory @ Southern Arm)	U	H	2	3	14.8	Geom	-	4.00	0.00	Y	Arm J1:7 Ahead	Inf
J1:7/1	U		2	3	30.4	Inf	-	-	-	-	-	-
J1:7/2	U		2	3	30.4	Inf	-	-	-	-	-	-
J1:7/3	U		2	3	30.4	Inf	-	-	-	-	-	-
J1:8/1 (Oil Terminal)	U		2	3	60.0	Inf	-	-	-	-	-	-
J1:9/1 (Circulatory @ Eastern Arm)	U	F	2	3	10.4	Geom	-	4.00	0.00	Y	Arm J1:12 Ahead	40.00
J1:9/2 (Circulatory @ Eastern Arm)	U	F	2	3	9.6	Geom	-	4.00	0.00	Y	Arm J1:6 Right	35.00
											Arm J1:12 Ahead	35.00
J1:10/1 (A6MARR Western Arm)	U		2	3	60.0	Inf	-	-	-	-	-	-
J1:11/1 (A6MARR Link Road)	U	G	2	3	22.6	Geom	-	4.75	0.00	Y	Arm J1:7 Left	30.00
J1:11/2 (A6MARR Link Road)	U	G	2	3	22.6	Geom	-	4.75	0.00	Y	Arm J1:7 Left	35.00
J1:12/1 (A6MARR Link Road)	U		2	3	1.7	Inf	-	-	-	-	-	-

Junction: J2: Chester Road												
Lane	Lane Type	Phases	Start Disp.	End Disp.	Physical Length (PCU)	Sat Flow Type	Def User Saturation Flow (PCU/Hr)	Lane Width (m)	Gradient	Nearside Lane	Turns	Turning Radius (m)
J2:1/1 (A6MARR Link Road)	U	C	2	3	26.1	Geom	-	5.00	0.00	Y	Arm J2:5 Left	20.00
J2:1/2 (A6MARR Link Road)	U	B	2	3	26.1	Geom	-	3.50	0.00	N	Arm J2:3 Ahead	Inf
J2:2/1 (Chester Road (south))	U	A	2	3	60.0	Geom	-	3.60	0.00	Y	Arm J2:6 Ahead	Inf
J2:2/2 (Chester Road (south))	U	A	2	3	12.2	Geom	-	3.60	0.00	N	Arm J2:5 Right	10.00
J2:3/1 (Chester Road (south))	U		2	3	60.0	Inf	-	-	-	-	-	-
J2:4/1 (Chester Road)	U	D	2	3	15.7	Geom	-	5.00	0.00	Y	Arm J2:3 Left	20.00
J2:4/2 (Chester Road)	U	E	2	3	34.8	Geom	-	3.50	0.00	Y	Arm J2:6 Right	10.00
J2:4/3 (Chester Road)	U	E	2	3	33.0	Geom	-	3.50	0.00	N	Arm J2:6 Right	10.00
J2:5/1 (Chester Road)	U		2	3	60.0	Inf	-	-	-	-	-	-
J2:6/1 (A6MARR Link Road)	U		2	3	1.7	Inf	-	-	-	-	-	-

Junction: J3: Unnamed Junction												
Lane	Lane Type	Phases	Start Disp.	End Disp.	Physical Length (PCU)	Sat Flow Type	Def User Saturation Flow (PCU/Hr)	Lane Width (m)	Gradient	Nearside Lane	Turns	Turning Radius (m)
J3:1/1 (A6MARR Eastern Arm (Ped Crossing))	U	A	2	3	20.0	Geom	-	3.50	0.00	Y	Arm J3:2 Ahead	Inf
J3:1/2 (A6MARR Eastern Arm (Ped Crossing))	U	A	2	3	20.0	Geom	-	3.50	0.00	N	Arm J3:2 Ahead	Inf
J3:2/1 (Eastern Arm)	U		2	3	60.0	Inf	-	-	-	-	-	-

Traffic Flow Groups

Flow Group	Start Time	End Time	Duration	Formula
1: '2017 AM'	08:00	09:00	01:00	
2: '2017 PM'	17:00	18:00	01:00	

Scenario 1: '2017 AM' (FG1: '2017 AM', Plan 1: 'Network Control Plan 1')

Traffic Flows, Desired

Desired Flow :

	Destination						
		A	B	C	D	E	Tot.
Origin	A	0	28	0	88	255	371
	B	18	0	10	1135	568	1731
	C	0	10	0	10	0	20
	D	169	1404	10	0	7	1590
	E	379	856	0	4	0	1239
	Tot.	566	2298	20	1237	830	4951

Traffic Lane Flows

Lane	Scenario 1: 2017 AM
Junction: J1: Oil Terminal Gyratory	
J1:1/1	589
J1:1/2 (with short)	1142(In) 556(Out)
J1:1/3 (short)	586
J1:2/1 (short)	20
J1:2/2 (with short)	634(In) 614(Out)
J1:2/3	613
J1:2/4	586
J1:3/1	20
J1:4/1	480
J1:4/2 (with short)	1110(In) 582(Out)
J1:4/3 (short)	528
J1:5/1	45
J1:5/2	57
J1:6/1	310
J1:6/2	584
J1:6/3	530
J1:7/1	802
J1:7/2	780
J1:7/3	818
J1:8/1	20
J1:9/1	300
J1:9/2	296
J1:10/1	2298
J1:11/1	492
J1:11/2	484
J1:12/1	762

Lane	Scenario 1: 2017 AM
Junction: J2: Chester Road	
J2:1/1	575
J2:1/2	187
J2:2/1 (with short)	371(In) 116(Out)
J2:2/2 (short)	255
J2:3/1	566
J2:4/1 (short)	379
J2:4/2 (with short)	835(In) 456(Out)
J2:4/3	404
J2:5/1	830
J2:6/1	976
Junction: J3: Unnamed Junction	
J3:1/1	614
J3:1/2	623
J3:2/1	1237

Lane Saturation Flows

Junction: J1: Oil Terminal Gyratory								
Lane	Lane Width (m)	Gradient	Nearside Lane	Allowed Turns	Turning Radius (m)	Turning Prop.	Sat Flow (PCU/Hr)	Flared Sat Flow (PCU/Hr)
J1:1/1 (A6MARR Western Arm)	3.66	0.00	Y	Arm J1:2 Ahead	Inf	100.0 %	1981	1981
J1:1/2 (A6MARR Western Arm)	3.66	0.00	N	Arm J1:2 Ahead	Inf	100.0 %	2121	2121
J1:1/3 (A6MARR Western Arm)	3.66	0.00	Y	Arm J1:2 Ahead	Inf	100.0 %	1981	1981
J1:2/1 (Circulatory @ Oil Terminal)	5.00	0.00	Y	Arm J1:8 Left	20.00	100.0 %	1967	1967
J1:2/2 (Circulatory @ Oil Terminal)	4.00	0.00	Y	Arm J3:1 Ahead	Inf	100.0 %	2015	2015
J1:2/3 (Circulatory @ Oil Terminal)	4.00	0.00	Y	Arm J3:1 Ahead	Inf	100.0 %	2015	2015
J1:2/4 (Circulatory @ Oil Terminal)	4.00	0.00	N	Arm J1:9 Right	Inf	100.0 %	2155	2155
J1:3/1 (Oil Terminal)	5.00	0.00	Y	Arm J1:9 Ahead	20.00	50.0 %	1967	1967
				Arm J3:1 Left	20.00	50.0 %		
J1:4/1 (A6MARR Eastern Arm)	3.66	0.00	Y	Arm J1:6 Ahead	Inf	63.3 %	1981	1981
				Arm J1:12 Left	Inf	36.7 %		
J1:4/2 (A6MARR Eastern Arm)	3.66	0.00	N	Arm J1:6 Ahead	Inf	100.0 %	2121	2121
J1:4/3 (A6MARR Eastern Arm)	3.66	0.00	Y	Arm J1:6 Ahead	Inf	100.0 %	1981	1981
J1:5/1 (Circulatory @ Western Arm)	3.90	0.00	Y	Arm J1:2 Right	Inf	100.0 %	2005	2005
J1:5/2 (Circulatory @ Western Arm)	3.90	0.00	Y	Arm J1:2 Right	30.00	100.0 %	1910	1910
J1:6/1 (Circulatory @ Southern Arm)	4.00	0.00	Y	Arm J1:7 Ahead	Inf	100.0 %	2015	2015
J1:6/2 (Circulatory @ Southern Arm)	4.00	0.00	N	Arm J1:7 Ahead	Inf	100.0 %	2155	2155
J1:6/3 (Circulatory @ Southern Arm)	4.00	0.00	Y	Arm J1:7 Ahead	Inf	100.0 %	2015	2015
J1:7/1				Infinite Saturation Flow			Inf	Inf

J1:7/2	Infinite Saturation Flow						Inf	Inf
J1:7/3	Infinite Saturation Flow						Inf	Inf
J1:8/1 (Oil Terminal Lane 1)	Infinite Saturation Flow						Inf	Inf
J1:9/1 (Circulatory @ Eastern Arm)	4.00	0.00	Y	Arm J1:12 Ahead	40.00	100.0 %	1942	1942
J1:9/2 (Circulatory @ Eastern Arm)	4.00	0.00	Y	Arm J1:6 Right Arm J1:12 Ahead	35.00 35.00	3.4 % 96.6 %	1932	1932
J1:10/1 (A6MARR Western Arm Lane 1)	Infinite Saturation Flow						Inf	Inf
J1:11/1 (A6MARR Link Road)	4.75	0.00	Y	Arm J1:7 Left	30.00	100.0 %	1990	1990
J1:11/2 (A6MARR Link Road)	4.75	0.00	Y	Arm J1:7 Left	35.00	100.0 %	2004	2004
J1:12/1 (A6MARR Link Road Lane 1)	Infinite Saturation Flow						Inf	Inf

Junction: J2: Chester Road								
Lane	Lane Width (m)	Gradient	Nearside Lane	Allowed Turns	Turning Radius (m)	Turning Prop.	Sat Flow (PCU/Hr)	Flared Sat Flow (PCU/Hr)
J2:1/1 (A6MARR Link Road)	5.00	0.00	Y	Arm J2:5 Left	20.00	100.0 %	1967	1967
J2:1/2 (A6MARR Link Road)	3.50	0.00	N	Arm J2:3 Ahead	Inf	100.0 %	2105	2105
J2:2/1 (Chester Road (south))	3.60	0.00	Y	Arm J2:6 Ahead	Inf	100.0 %	1975	1975
J2:2/2 (Chester Road (south))	3.60	0.00	N	Arm J2:5 Right	10.00	100.0 %	1839	1839
J2:3/1 (Chester Road (south) Lane 1)	Infinite Saturation Flow						Inf	Inf
J2:4/1 (Chester Road)	5.00	0.00	Y	Arm J2:3 Left	20.00	100.0 %	1967	1967
J2:4/2 (Chester Road)	3.50	0.00	Y	Arm J2:6 Right	10.00	100.0 %	1709	1709
J2:4/3 (Chester Road)	3.50	0.00	N	Arm J2:6 Right	10.00	100.0 %	1830	1830
J2:5/1 (Chester Road Lane 1)	Infinite Saturation Flow						Inf	Inf
J2:6/1 (A6MARR Link Road Lane 1)	Infinite Saturation Flow						Inf	Inf

Junction: J3: Unnamed Junction								
Lane	Lane Width (m)	Gradient	Nearside Lane	Allowed Turns	Turning Radius (m)	Turning Prop.	Sat Flow (PCU/Hr)	Flared Sat Flow (PCU/Hr)
J3:1/1 (A6MARR Eastern Arm (Ped Crossing))	3.50	0.00	Y	Arm J3:2 Ahead	Inf	100.0 %	1965	1965
J3:1/2 (A6MARR Eastern Arm (Ped Crossing))	3.50	0.00	N	Arm J3:2 Ahead	Inf	100.0 %	2105	2105
J3:2/1 (Eastern Arm Lane 1)	Infinite Saturation Flow						Inf	Inf

Scenario 2: '2017 PM' (FG2: '2017 PM', Plan 1: 'Network Control Plan 1')

Traffic Flows, Desired

Desired Flow :

	Destination						
	A	B	C	D	E	Tot.	
Origin	A	0	40	0	237	405	682
B	32	0	10	1640	765	2447	
C	0	10	0	10	0	20	
D	86	1031	10	0	12	1139	
E	286	518	0	8	0	812	
Tot.	404	1599	20	1895	1182	5100	

Traffic Lane Flows

Lane	Scenario 2: 2017 PM
Junction: J1: Oil Terminal Gyratory	
J1:1/1	854
J1:1/2 (with short)	1593(In) 796(Out)
J1:1/3 (short)	797
J1:2/1 (short)	20
J1:2/2 (with short)	977(In) 957(Out)
J1:2/3	928
J1:2/4	797
J1:3/1	20
J1:4/1	325
J1:4/2 (with short)	814(In) 428(Out)
J1:4/3 (short)	386
J1:5/1	123
J1:5/2	132
J1:6/1	235
J1:6/2	429
J1:6/3	387
J1:7/1	575
J1:7/2	538
J1:7/3	741
J1:8/1	20
J1:9/1	406
J1:9/2	401
J1:10/1	1599
J1:11/1	340
J1:11/2	463
J1:12/1	895

Lane	Scenario 2: 2017 PM
Junction: J2: Chester Road	
J2:1/1	777
J2:1/2	118
J2:2/1 (with short)	682(In) 277(Out)
J2:2/2 (short)	405
J2:3/1	404
J2:4/1 (short)	286
J2:4/2 (with short)	601(In) 315(Out)
J2:4/3	211
J2:5/1	1182
J2:6/1	803
Junction: J3: Unnamed Junction	
J3:1/1	958
J3:1/2	937
J3:2/1	1895

Lane Saturation Flows

Junction: J1: Oil Terminal Gyratory								
Lane	Lane Width (m)	Gradient	Nearside Lane	Allowed Turns	Turning Radius (m)	Turning Prop.	Sat Flow (PCU/Hr)	Flared Sat Flow (PCU/Hr)
J1:1/1 (A6MARR Western Arm)	3.66	0.00	Y	Arm J1:2 Ahead	Inf	100.0 %	1981	1981
J1:1/2 (A6MARR Western Arm)	3.66	0.00	N	Arm J1:2 Ahead	Inf	100.0 %	2121	2121
J1:1/3 (A6MARR Western Arm)	3.66	0.00	Y	Arm J1:2 Ahead	Inf	100.0 %	1981	1981
J1:2/1 (Circulatory @ Oil Terminal)	5.00	0.00	Y	Arm J1:8 Left	20.00	100.0 %	1967	1967
J1:2/2 (Circulatory @ Oil Terminal)	4.00	0.00	Y	Arm J3:1 Ahead	Inf	100.0 %	2015	2015
J1:2/3 (Circulatory @ Oil Terminal)	4.00	0.00	Y	Arm J3:1 Ahead	Inf	100.0 %	2015	2015
J1:2/4 (Circulatory @ Oil Terminal)	4.00	0.00	N	Arm J1:9 Right	Inf	100.0 %	2155	2155
J1:3/1 (Oil Terminal)	5.00	0.00	Y	Arm J1:9 Ahead	20.00	50.0 %	1967	1967
				Arm J3:1 Left	20.00	50.0 %		
J1:4/1 (A6MARR Eastern Arm)	3.66	0.00	Y	Arm J1:6 Ahead	Inf	69.8 %	1981	1981
				Arm J1:12 Left	Inf	30.2 %		
J1:4/2 (A6MARR Eastern Arm)	3.66	0.00	N	Arm J1:6 Ahead	Inf	100.0 %	2121	2121
J1:4/3 (A6MARR Eastern Arm)	3.66	0.00	Y	Arm J1:6 Ahead	Inf	100.0 %	1981	1981
J1:5/1 (Circulatory @ Western Arm)	3.90	0.00	Y	Arm J1:2 Right	Inf	100.0 %	2005	2005
J1:5/2 (Circulatory @ Western Arm)	3.90	0.00	Y	Arm J1:2 Right	30.00	100.0 %	1910	1910
J1:6/1 (Circulatory @ Southern Arm)	4.00	0.00	Y	Arm J1:7 Ahead	Inf	100.0 %	2015	2015
J1:6/2 (Circulatory @ Southern Arm)	4.00	0.00	N	Arm J1:7 Ahead	Inf	100.0 %	2155	2155
J1:6/3 (Circulatory @ Southern Arm)	4.00	0.00	Y	Arm J1:7 Ahead	Inf	100.0 %	2015	2015
J1:7/1				Infinite Saturation Flow			Inf	Inf

J1:7/2	Infinite Saturation Flow						Inf	Inf
J1:7/3	Infinite Saturation Flow						Inf	Inf
J1:8/1 (Oil Terminal Lane 1)	Infinite Saturation Flow						Inf	Inf
J1:9/1 (Circulatory @ Eastern Arm)	4.00	0.00	Y	Arm J1:12 Ahead	40.00	100.0 %	1942	1942
J1:9/2 (Circulatory @ Eastern Arm)	4.00	0.00	Y	Arm J1:6 Right Arm J1:12 Ahead	35.00 35.00	2.5 % 97.5 %	1932	1932
J1:10/1 (A6MARR Western Arm Lane 1)	Infinite Saturation Flow						Inf	Inf
J1:11/1 (A6MARR Link Road)	4.75	0.00	Y	Arm J1:7 Left	30.00	100.0 %	1990	1990
J1:11/2 (A6MARR Link Road)	4.75	0.00	Y	Arm J1:7 Left	35.00	100.0 %	2004	2004
J1:12/1 (A6MARR Link Road Lane 1)	Infinite Saturation Flow						Inf	Inf

Junction: J2: Chester Road								
Lane	Lane Width (m)	Gradient	Nearside Lane	Allowed Turns	Turning Radius (m)	Turning Prop.	Sat Flow (PCU/Hr)	Flared Sat Flow (PCU/Hr)
J2:1/1 (A6MARR Link Road)	5.00	0.00	Y	Arm J2:5 Left	20.00	100.0 %	1967	1967
J2:1/2 (A6MARR Link Road)	3.50	0.00	N	Arm J2:3 Ahead	Inf	100.0 %	2105	2105
J2:2/1 (Chester Road (south))	3.60	0.00	Y	Arm J2:6 Ahead	Inf	100.0 %	1975	1975
J2:2/2 (Chester Road (south))	3.60	0.00	N	Arm J2:5 Right	10.00	100.0 %	1839	1839
J2:3/1 (Chester Road (south) Lane 1)	Infinite Saturation Flow						Inf	Inf
J2:4/1 (Chester Road)	5.00	0.00	Y	Arm J2:3 Left	20.00	100.0 %	1967	1967
J2:4/2 (Chester Road)	3.50	0.00	Y	Arm J2:6 Right	10.00	100.0 %	1709	1709
J2:4/3 (Chester Road)	3.50	0.00	N	Arm J2:6 Right	10.00	100.0 %	1830	1830
J2:5/1 (Chester Road Lane 1)	Infinite Saturation Flow						Inf	Inf
J2:6/1 (A6MARR Link Road Lane 1)	Infinite Saturation Flow						Inf	Inf

Junction: J3: Unnamed Junction								
Lane	Lane Width (m)	Gradient	Nearside Lane	Allowed Turns	Turning Radius (m)	Turning Prop.	Sat Flow (PCU/Hr)	Flared Sat Flow (PCU/Hr)
J3:1/1 (A6MARR Eastern Arm (Ped Crossing))	3.50	0.00	Y	Arm J3:2 Ahead	Inf	100.0 %	1965	1965
J3:1/2 (A6MARR Eastern Arm (Ped Crossing))	3.50	0.00	N	Arm J3:2 Ahead	Inf	100.0 %	2105	2105
J3:2/1 (Eastern Arm Lane 1)	Infinite Saturation Flow						Inf	Inf

Scenario 1: '2017 AM' (FG1: '2017 AM', Plan 1: 'Network Control Plan 1')

C1

Stage Sequence Diagram

Stage Stream: 1

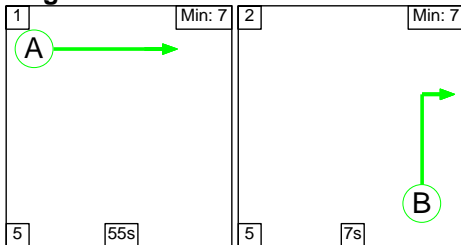

Stage Stream: 2

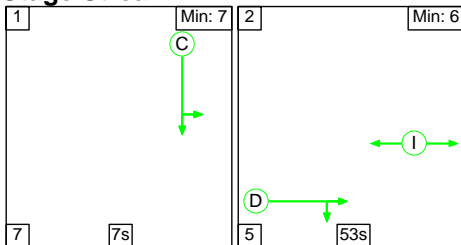

Stage Stream: 3

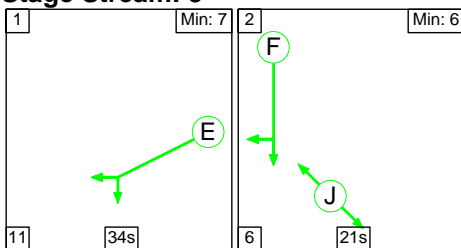

Stage Stream: 4

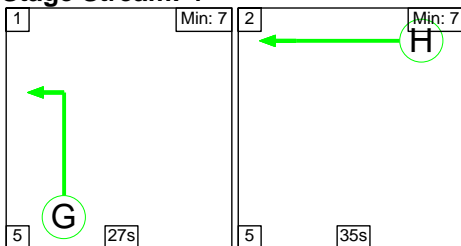

Stage Stream: 5

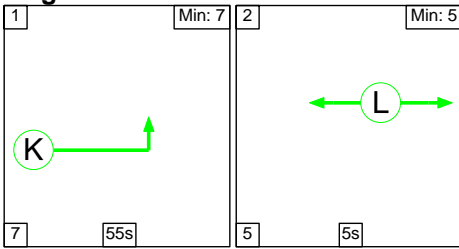

Stage Timings

Stage Stream: 1

Stage	1	2
Duration	55	7
Change Point	29	17

Stage Stream: 2

Stage	1	2
Duration	7	53
Change Point	32	46

Stage Stream: 3

Stage	1	2
Duration	34	21
Change Point	6	51

Stage Stream: 4

Stage	1	2
Duration	27	35
Change Point	61	21

Stage Stream: 5

Stage	1	2
Duration	55	5
Change Point	33	23

Signal Timings Diagram

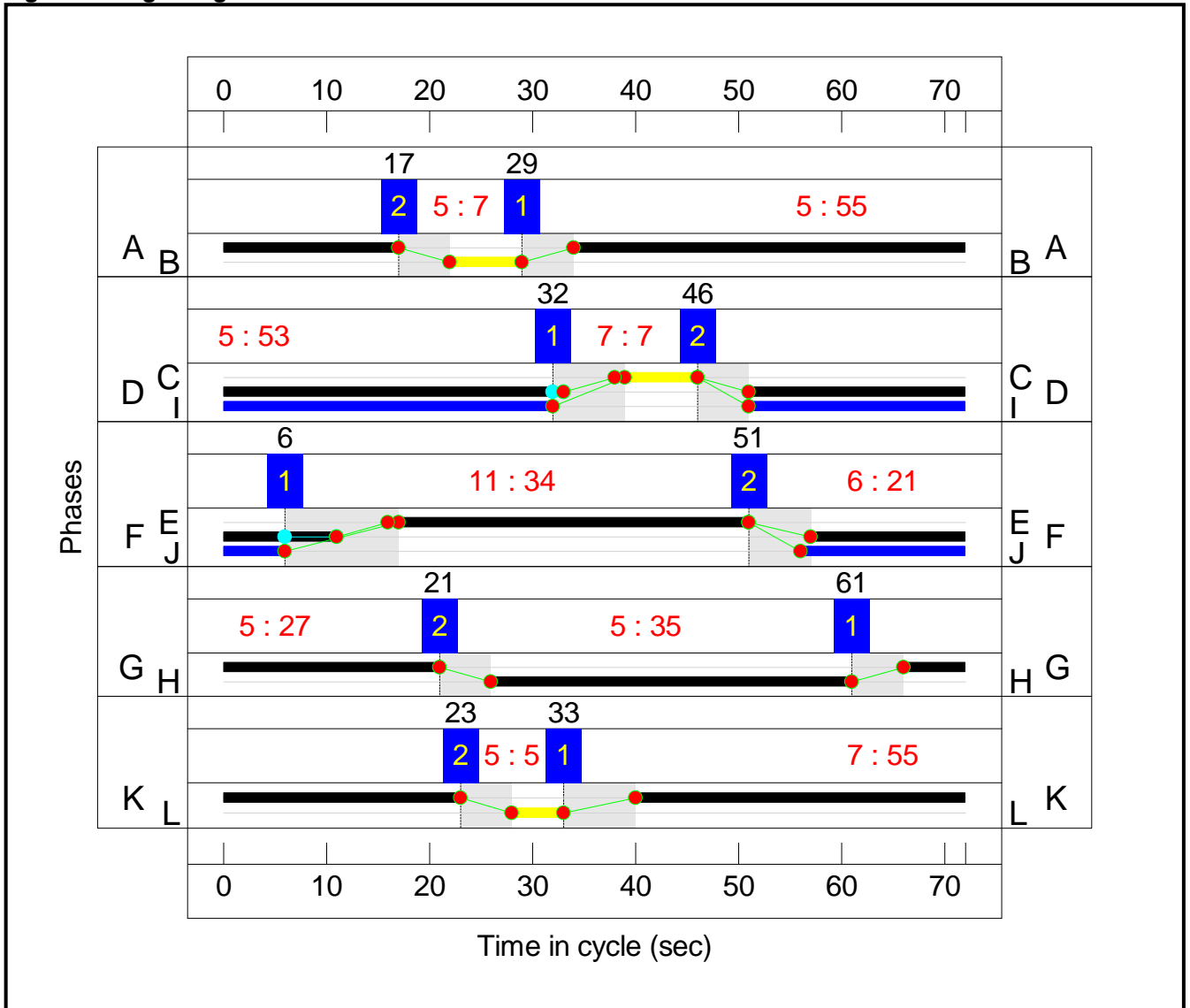

C2 Stage Sequence Diagram

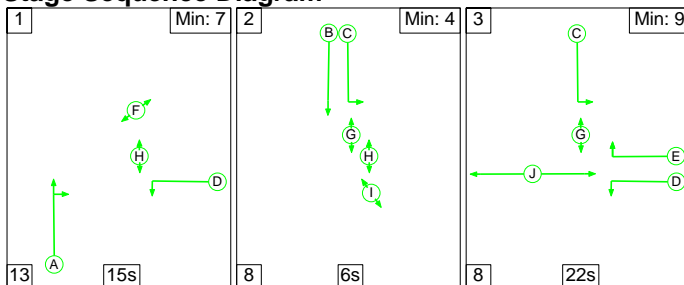

Stage Timings

Stage	1	2	3
Duration	15	6	22
Change Point	6	34	48

Signal Timings Diagram

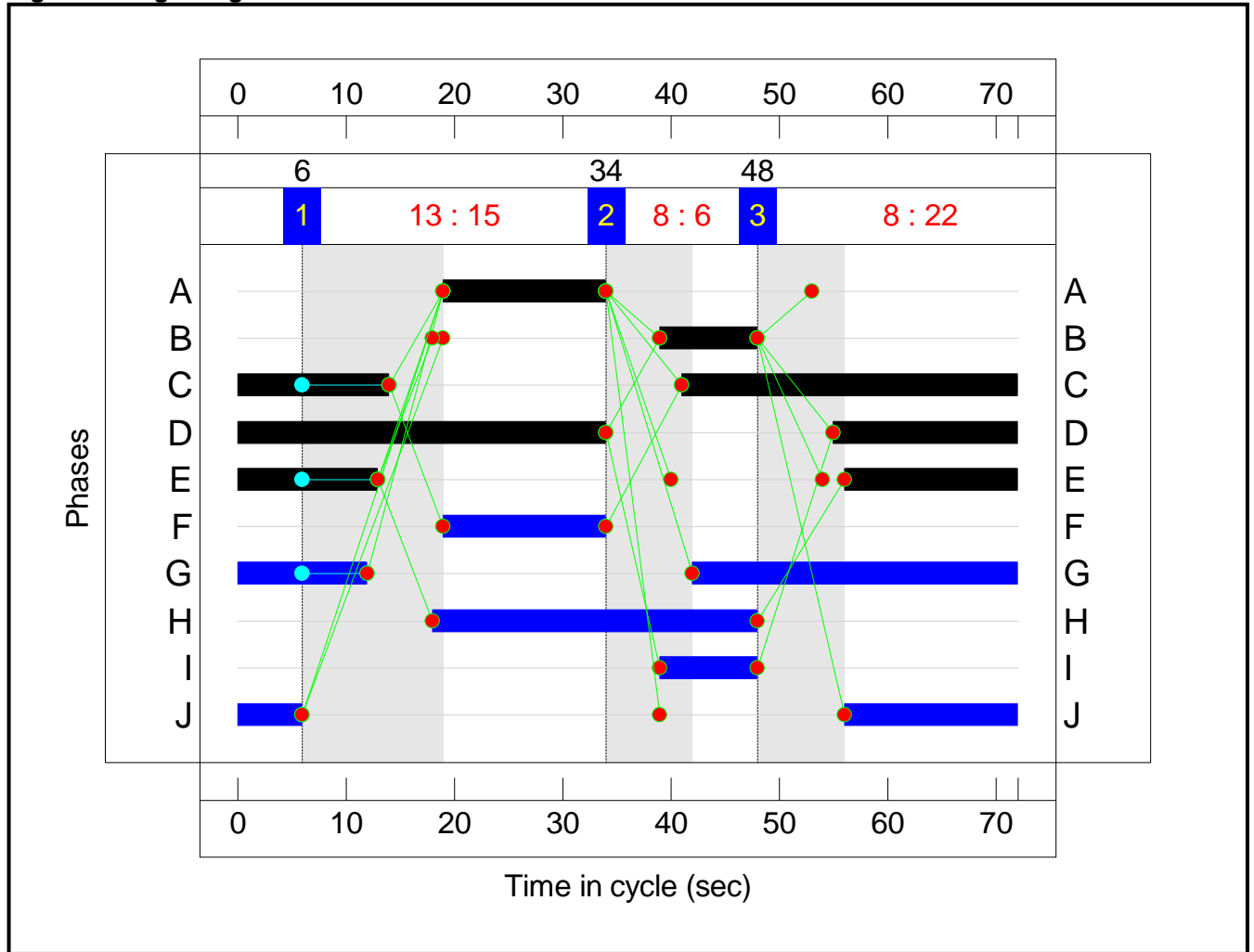

C3 Stage Sequence Diagram

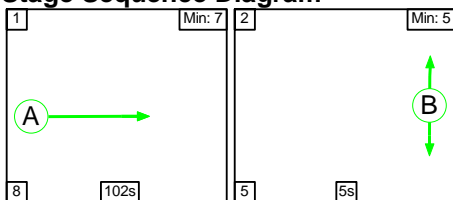

Stage Timings

Stage	1	2
Duration	102	5
Change Point	6	116

Signal Timings Diagram

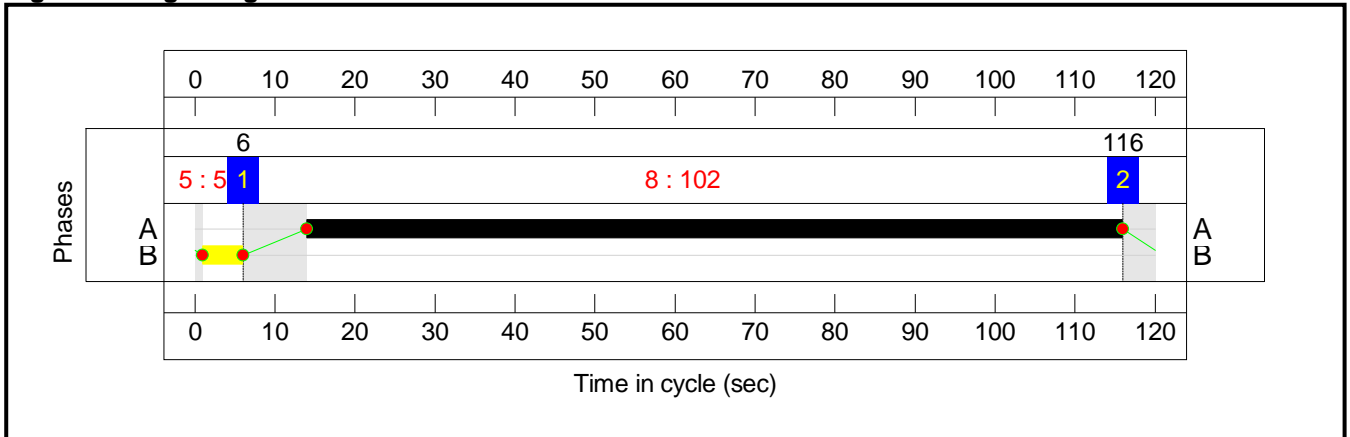

Network Layout Diagram

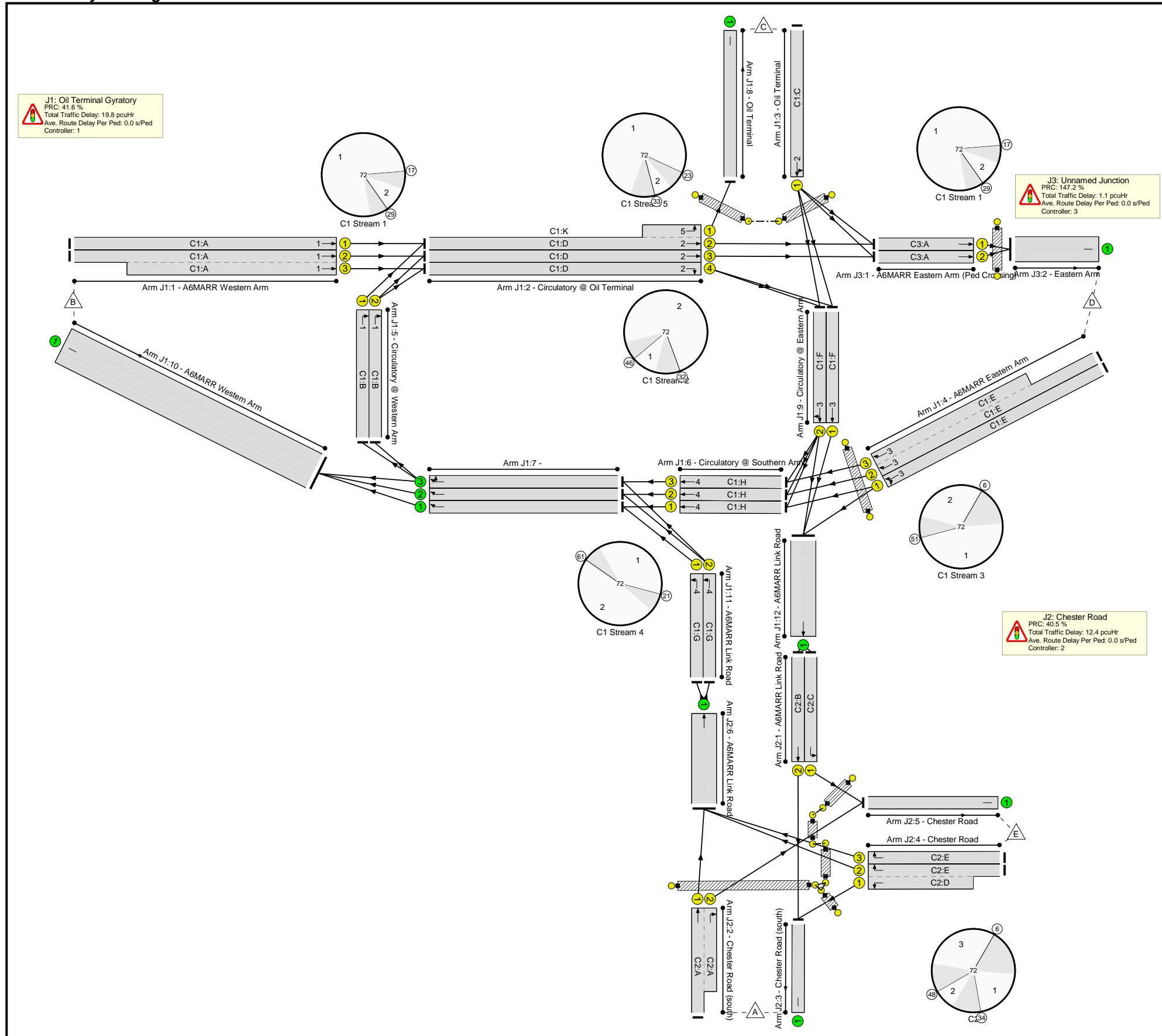

Network Results

Item	Lane Description	Lane Type	Controller Stream	Position In Filtered Route	Full Phase	Arrow Phase	Num Greens	Total Green (s)	Arrow Green (s)	Demand Flow (pcu)	Sat Flow (pcu/Hr)	Capacity (pcu)	Deg Sat (%)
Network: Oil Terminal Gyratory	-	-	N/A	-	-		-	-	-	-	-	-	64.0%
J1: Oil Terminal Gyratory	-	-	N/A	-	-		-	-	-	-	-	-	63.6%
1/1	A6MARR Western Arm Ahead	U	1:1	N/A	C1:A		1	55	-	589	1981	1541	38.2%
1/2+1/3	A6MARR Western Arm Ahead	U	1:1	N/A	C1:A		1	55	-	1142	2121:1981	997+1050	55.8 : 55.8%
2/2+2/1	Circulatory @ Oil Terminal Left Ahead	U	1:2	N/A	C1:D C1:K		1	54:55	-	634	2015:1967	1487+48	41.3 : 41.3%
2/3	Circulatory @ Oil Terminal Ahead	U	1:2	N/A	C1:D		1	54	-	613	2015	1539	39.8%
2/4	Circulatory @ Oil Terminal Right	U	1:2	N/A	C1:D		1	54	-	586	2155	1646	35.6%
3/1	Oil Terminal Ahead Left	U	1:2	N/A	C1:C		1	7	-	20	1967	219	9.2%
4/1	A6MARR Eastern Arm Ahead Left	U	1:3	N/A	C1:E		1	34	-	480	1981	963	49.8%
4/2+4/3	A6MARR Eastern Arm Ahead	U	1:3	N/A	C1:E		1	34	-	1110	2121:1981	1031+947	56.4 : 55.7%
5/1	Circulatory @ Western Arm Right	U	1:1	N/A	C1:B		1	7	-	45	2005	223	20.2%
5/2	Circulatory @ Western Arm Right	U	1:1	N/A	C1:B		1	7	-	57	1910	212	26.9%
6/1	Circulatory @ Southern Arm Ahead	U	1:4	N/A	C1:H		1	35	-	310	2015	1007	30.8%
6/2	Circulatory @ Southern Arm Ahead	U	1:4	N/A	C1:H		1	35	-	584	2155	1077	54.2%
6/3	Circulatory @ Southern Arm Ahead	U	1:4	N/A	C1:H		1	35	-	530	2015	1007	52.6%

Item	Lane Description	Lane Type	Controller Stream	Position In Filtered Route	Full Phase	Arrow Phase	Num Greens	Total Green (s)	Arrow Green (s)	Demand Flow (pcu)	Sat Flow (pcu/Hr)	Capacity (pcu)	Deg Sat (%)
7/1	Ahead	U	N/A	N/A	-		-	-	-	802	Inf	Inf	0.0%
7/2	Ahead	U	N/A	N/A	-		-	-	-	780	Inf	Inf	0.0%
7/3	Right Ahead	U	N/A	N/A	-		-	-	-	818	Inf	Inf	0.0%
8/1	Oil Terminal	U	N/A	N/A	-		-	-	-	20	Inf	Inf	0.0%
9/1	Circulatory @ Eastern Arm Ahead	U	1:3	N/A	C1:F		1	26	-	300	1942	728	41.2%
9/2	Circulatory @ Eastern Arm Right Ahead	U	1:3	N/A	C1:F		1	26	-	296	1932	725	40.9%
10/1	A6MARR Western Arm	U	N/A	N/A	-		-	-	-	2298	Inf	Inf	0.0%
11/1	A6MARR Link Road Left	U	1:4	N/A	C1:G		1	27	-	492	1990	774	63.6%
11/2	A6MARR Link Road Left	U	1:4	N/A	C1:G		1	27	-	484	2004	779	62.1%
12/1	A6MARR Link Road Ahead	U	N/A	N/A	-		-	-	-	762	Inf	Inf	0.0%
Ped Link: P1	Unnamed Ped Link	-	1:3	-	C1:J		1	22	-	0	-	0	0.0%
Ped Link: P2	Unnamed Ped Link	-	1:2	-	C1:I		1	53	-	0	-	0	0.0%
Ped Link: P3	Unnamed Ped Link	-	1:5	-	C1:L		1	5	-	0	-	0	0.0%
J2: Chester Road	-	-	N/A	-	-		-	-	-	-	-	-	64.0%
1/1	A6MARR Link Road Left	U	N/A	N/A	C2:C		1	45	-	575	1967	1257	45.8%
1/2	A6MARR Link Road Ahead	U	N/A	N/A	C2:B		1	9	-	187	2105	292	64.0%
2/1+2/2	Chester Road (south) Right Ahead	U	N/A	N/A	C2:A		1	15	-	371	1975:1839	186+409	62.4 : 62.4%
3/1	Chester Road (south)	U	N/A	N/A	-		-	-	-	566	Inf	Inf	0.0%
4/2+4/1	Chester Road Left Right	U	N/A	N/A	C2:E C2:D		1	29:51	-	835	1709:1967	712+592	64.0 : 64.0%
4/3	Chester Road Right	U	N/A	N/A	C2:E		1	29	-	404	1830	762	53.0%

Item	Lane Description	Lane Type	Controller Stream	Position In Filtered Route	Full Phase	Arrow Phase	Num Greens	Total Green (s)	Arrow Green (s)	Demand Flow (pcu)	Sat Flow (pcu/Hr)	Capacity (pcu)	Deg Sat (%)
5/1	Chester Road	U	N/A	N/A	-		-	-	-	830	Inf	Inf	0.0%
6/1	A6MARR Link Road Ahead	U	N/A	N/A	-		-	-	-	976	Inf	Inf	0.0%
Ped Link: P1	Unnamed Ped Link	-	N/A	-	C2:F		1	15	-	0	-	0	0.0%
Ped Link: P2	Unnamed Ped Link	-	N/A	-	C2:G		1	42	-	0	-	0	0.0%
Ped Link: P3	Unnamed Ped Link	-	N/A	-	C2:H		1	30	-	0	-	0	0.0%
Ped Link: P4	Unnamed Ped Link	-	N/A	-	C2:J		1	22	-	0	-	0	0.0%
Ped Link: P5	Unnamed Ped Link	-	N/A	-	C2:I		1	9	-	0	-	0	0.0%
J3: Unnamed Junction	-	-	N/A	-	-		-	-	-	-	-	-	36.4%
1/1	A6MARR Eastern Arm (Ped Crossing) Ahead	U	N/A	N/A	C3:A		1	102	-	614	1965	1687	36.4%
1/2	A6MARR Eastern Arm (Ped Crossing) Ahead	U	N/A	N/A	C3:A		1	102	-	623	2105	1807	34.5%
2/1	Eastern Arm	U	N/A	N/A	-		-	-	-	1237	Inf	Inf	0.0%
Ped Link: P1	Unnamed Ped Link	-	N/A	-	C3:B		1	5	-	0	-	0	0.0%

Item	Arriving (pcu)	Leaving (pcu)	Turners In Gaps (pcu)	Turners When Unopposed (pcu)	Turners In Intergreen (pcu)	Uniform Delay (pcuHr)	Rand + Oversat Delay (pcuHr)	Storage Area Uniform Delay (pcuHr)	Total Delay (pcuHr)	Av. Delay Per PCU (s/pcu)	Max. Back of Uniform Queue (pcu)	Rand + Oversat Queue (pcu)	Mean Max Queue (pcu)
Network: Oil Terminal Gyrotory	-	-	0	0	0	22.2	11.3	0.0	33.4	-	-	-	-
J1: Oil Terminal Gyrotory	-	-	0	0	0	12.7	7.1	0.0	19.8	-	-	-	-
1/1	589	589	-	-	-	0.4	0.3	-	0.7	4.4	3.6	0.3	3.9
1/2+1/3	1142	1142	-	-	-	0.8	0.6	-	1.4	4.5	3.6	0.6	4.2
2/2+2/1	634	634	-	-	-	0.3	0.4	-	0.6	3.4	2.4	0.4	2.7
2/3	613	613	-	-	-	0.3	0.3	-	0.7	3.9	4.0	0.3	4.3
2/4	586	586	-	-	-	0.2	0.3	-	0.4	2.7	1.3	0.3	1.6
3/1	20	20	-	-	-	0.2	0.1	-	0.2	37.9	0.4	0.1	0.4
4/1	480	480	-	-	-	1.7	0.5	-	2.2	16.3	6.4	0.5	6.9
4/2+4/3	1110	1110	-	-	-	4.0	0.6	-	4.7	15.1	8.1	0.6	8.7
5/1	45	45	-	-	-	0.2	0.1	-	0.3	23.9	0.7	0.1	0.9
5/2	57	57	-	-	-	0.1	0.2	-	0.3	20.2	0.9	0.2	1.1
6/1	310	310	-	-	-	0.1	0.2	-	0.3	3.6	0.7	0.2	0.9
6/2	584	584	-	-	-	0.1	0.6	-	0.7	4.3	3.0	0.6	3.6
6/3	530	530	-	-	-	0.1	0.6	-	0.6	4.4	2.3	0.6	2.8
7/1	802	802	-	-	-	0.0	0.0	-	0.0	0.0	0.0	0.0	0.0
7/2	780	780	-	-	-	0.0	0.0	-	0.0	0.0	0.0	0.0	0.0
7/3	818	818	-	-	-	0.0	0.0	-	0.0	0.0	0.0	0.0	0.0
8/1	20	20	-	-	-	0.0	0.0	-	0.0	0.0	0.0	0.0	0.0
9/1	300	300	-	-	-	1.2	0.3	-	1.5	18.0	3.8	0.3	4.1

Item	Arriving (pcu)	Leaving (pcu)	Turners In Gaps (pcu)	Turners When Unopposed (pcu)	Turners In Intergreen (pcu)	Uniform Delay (pcuHr)	Rand + Oversat Delay (pcuHr)	Storage Area Uniform Delay (pcuHr)	Total Delay (pcuHr)	Av. Delay Per PCU (s/pcu)	Max. Back of Uniform Queue (pcu)	Rand + Oversat Queue (pcu)	Mean Max Queue (pcu)
9/2	296	296	-	-	-	1.1	0.3	-	1.5	18.1	3.8	0.3	4.2
10/1	2298	2298	-	-	-	0.0	0.0	-	0.0	0.0	0.0	0.0	0.0
11/1	492	492	-	-	-	0.7	0.9	-	1.6	11.6	1.7	0.9	2.5
11/2	484	484	-	-	-	1.3	0.8	-	2.1	15.8	4.0	0.8	4.8
12/1	762	762	-	-	-	0.0	0.0	-	0.0	0.0	0.0	0.0	0.0
Ped Link: P1	0	0	-	-	-	-	-	-	-	-	-	-	-
Ped Link: P2	0	0	-	-	-	-	-	-	-	-	-	-	-
Ped Link: P3	0	0	-	-	-	-	-	-	-	-	-	-	-
J2: Chester Road	-	-	0	0	0	8.9	3.6	0.0	12.4	-	-	-	-
1/1	575	575	-	-	-	1.0	0.4	-	1.4	8.9	6.7	0.4	7.2
1/2	187	187	-	-	-	1.1	0.9	-	2.0	37.6	3.3	0.9	4.1
2/1+2/2	371	371	-	-	-	2.5	0.8	-	3.4	32.6	4.6	0.8	5.4
3/1	566	566	-	-	-	0.0	0.0	-	0.0	0.0	0.0	0.0	0.0
4/2+4/1	835	835	-	-	-	2.5	0.9	-	3.4	14.5	7.2	0.9	8.1
4/3	404	404	-	-	-	1.8	0.6	-	2.3	20.7	5.9	0.6	6.5
5/1	830	830	-	-	-	0.0	0.0	-	0.0	0.0	0.0	0.0	0.0
6/1	976	976	-	-	-	0.0	0.0	-	0.0	0.0	0.0	0.0	0.0
Ped Link: P1	0	0	-	-	-	-	-	-	-	-	-	-	-
Ped Link: P2	0	0	-	-	-	-	-	-	-	-	-	-	-
Ped Link: P3	0	0	-	-	-	-	-	-	-	-	-	-	-
Ped Link: P4	0	0	-	-	-	-	-	-	-	-	-	-	-
Ped Link: P5	0	0	-	-	-	-	-	-	-	-	-	-	-

Item	Arriving (pcu)	Leaving (pcu)	Turners In Gaps (pcu)	Turners When Unopposed (pcu)	Turners In Intergreen (pcu)	Uniform Delay (pcuHr)	Rand + Oversat Delay (pcuHr)	Storage Area Uniform Delay (pcuHr)	Total Delay (pcuHr)	Av. Delay Per PCU (s/pcu)	Max. Back of Uniform Queue (pcu)	Rand + Oversat Queue (pcu)	Mean Max Queue (pcu)	
J3: Unnamed Junction	-	-	0	0	0	0.6	0.5	0.0	1.1	-	-	-	-	
1/1	614	614	-	-	-	0.3	0.3	-	0.6	3.4	4.1	0.3	4.4	
1/2	623	623	-	-	-	0.3	0.3	-	0.6	3.2	4.2	0.3	4.4	
2/1	1237	1237	-	-	-	0.0	0.0	-	0.0	0.0	0.0	0.0	0.0	
Ped Link: P1	0	0	-	-	-	-	-	-	-	-	-	-	-	
			C1	Stream: 1 PRC for Signalled Lanes (%)	61.3	Total Delay for Signalled Lanes (pcuHr):			2.76	Cycle Time (s):		72		
			C1	Stream: 2 PRC for Signalled Lanes (%)	118.0	Total Delay for Signalled Lanes (pcuHr):			1.91	Cycle Time (s):		72		
			C1	Stream: 3 PRC for Signalled Lanes (%)	59.4	Total Delay for Signalled Lanes (pcuHr):			9.82	Cycle Time (s):		72		
			C1	Stream: 4 PRC for Signalled Lanes (%)	41.6	Total Delay for Signalled Lanes (pcuHr):			5.36	Cycle Time (s):		72		
			C1	Stream: 5 PRC for Signalled Lanes (%)	0.0	Total Delay for Signalled Lanes (pcuHr):			0.00	Cycle Time (s):		72		
			C2	PRC for Signalled Lanes (%)	40.5	Total Delay for Signalled Lanes (pcuHr):			12.43	Cycle Time (s):		72		
			C3	PRC for Signalled Lanes (%)	147.2	Total Delay for Signalled Lanes (pcuHr):			1.14	Cycle Time (s):		120		
				PRC Over All Lanes (%)	40.5	Total Delay Over All Lanes (pcuHr):			33.42					

Scenario 2: '2017 PM' (FG2: '2017 PM', Plan 1: 'Network Control Plan 1')

C1

Stage Sequence Diagram

Stage Stream: 1

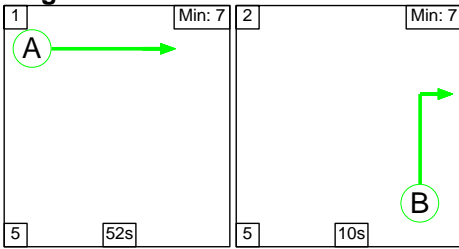

Stage Stream: 2

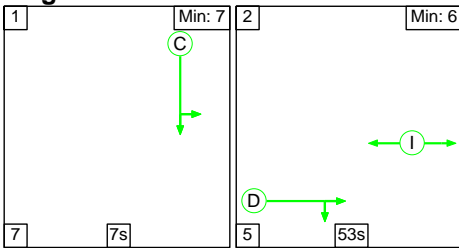

Stage Stream: 3

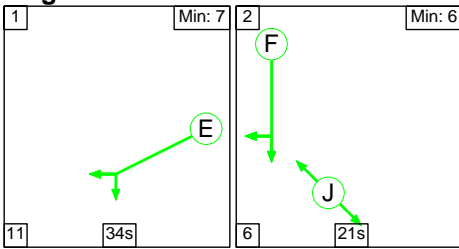

Stage Stream: 4

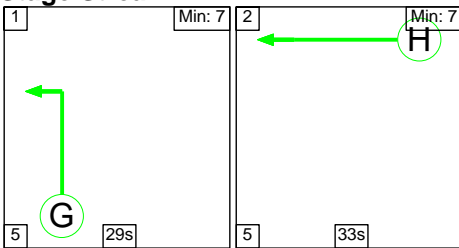

Stage Stream: 5

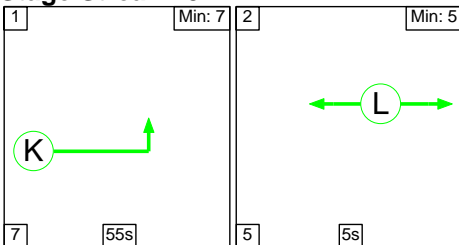

Stage Timings

Stage Stream: 1

Stage	1	2
Duration	52	10
Change Point	12	69

Stage Stream: 2

Stage	1	2
Duration	7	53
Change Point	12	26

Stage Stream: 3

Stage	1	2
Duration	34	21
Change Point	60	33

Stage Stream: 4

Stage	1	2
Duration	29	33
Change Point	25	59

Stage Stream: 5

Stage	1	2
Duration	55	5
Change Point	13	3

Signal Timings Diagram

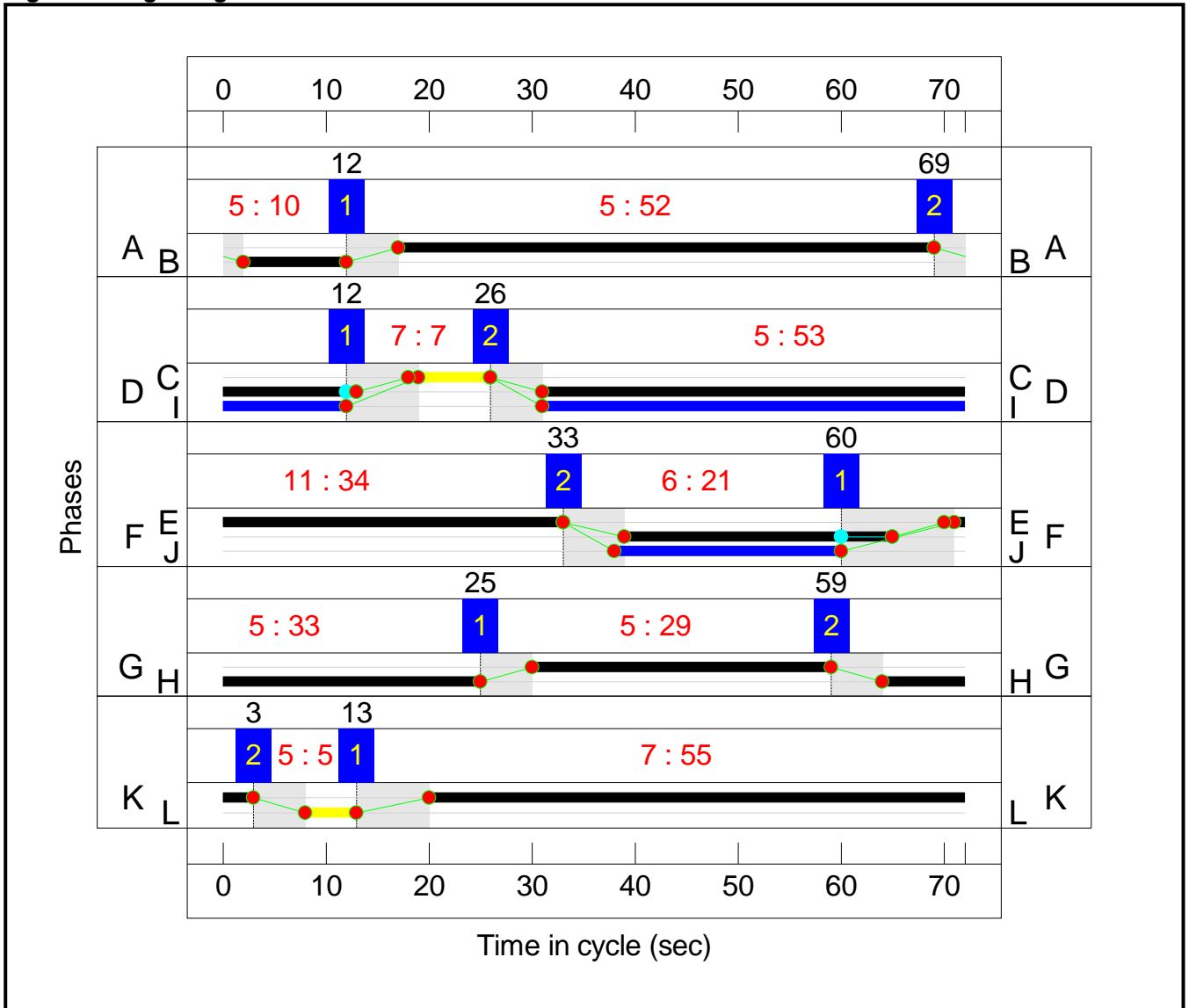

C2 Stage Sequence Diagram

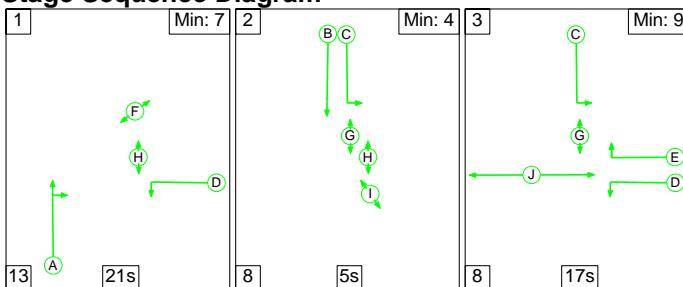

Stage Timings

Stage	1	2	3
Duration	21	5	17
Change Point	12	46	59

Signal Timings Diagram

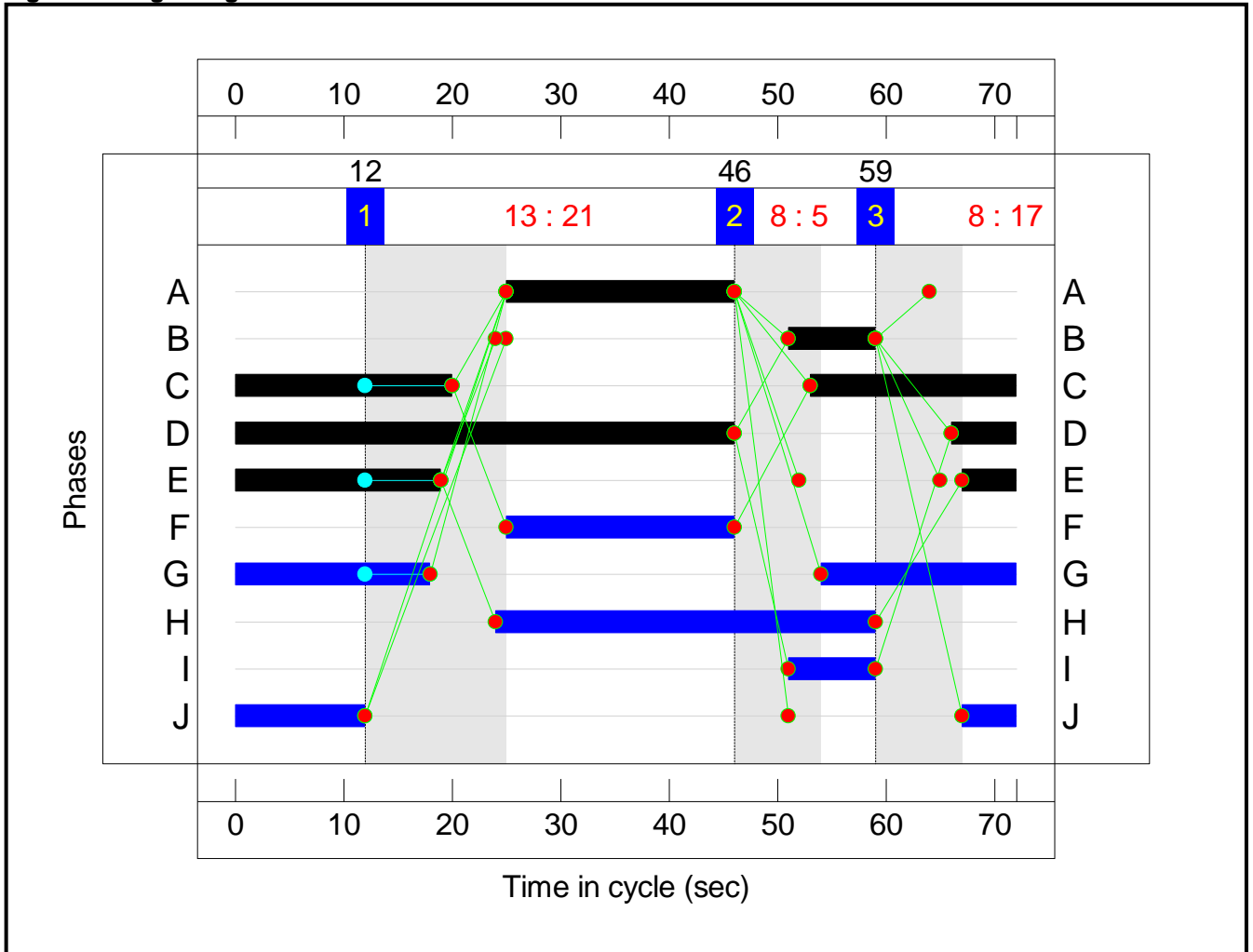

C3

Stage Sequence Diagram

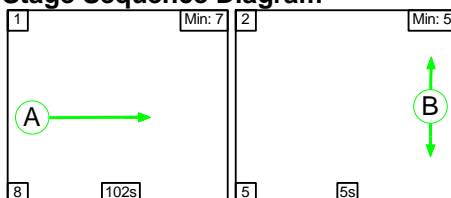

Stage Timings

Stage	1	2
Duration	102	5
Change Point	119	109

Signal Timings Diagram

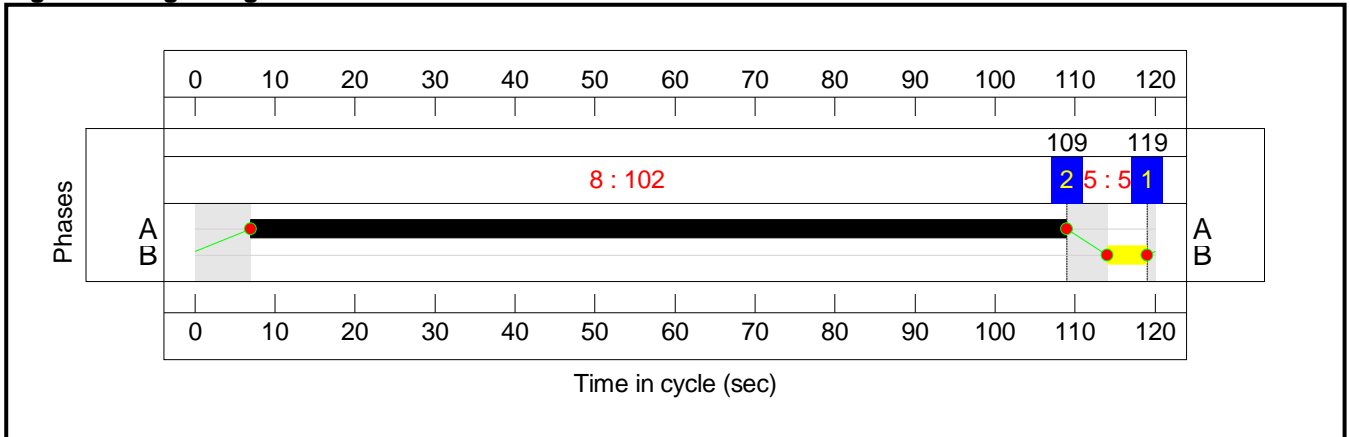

Network Layout Diagram

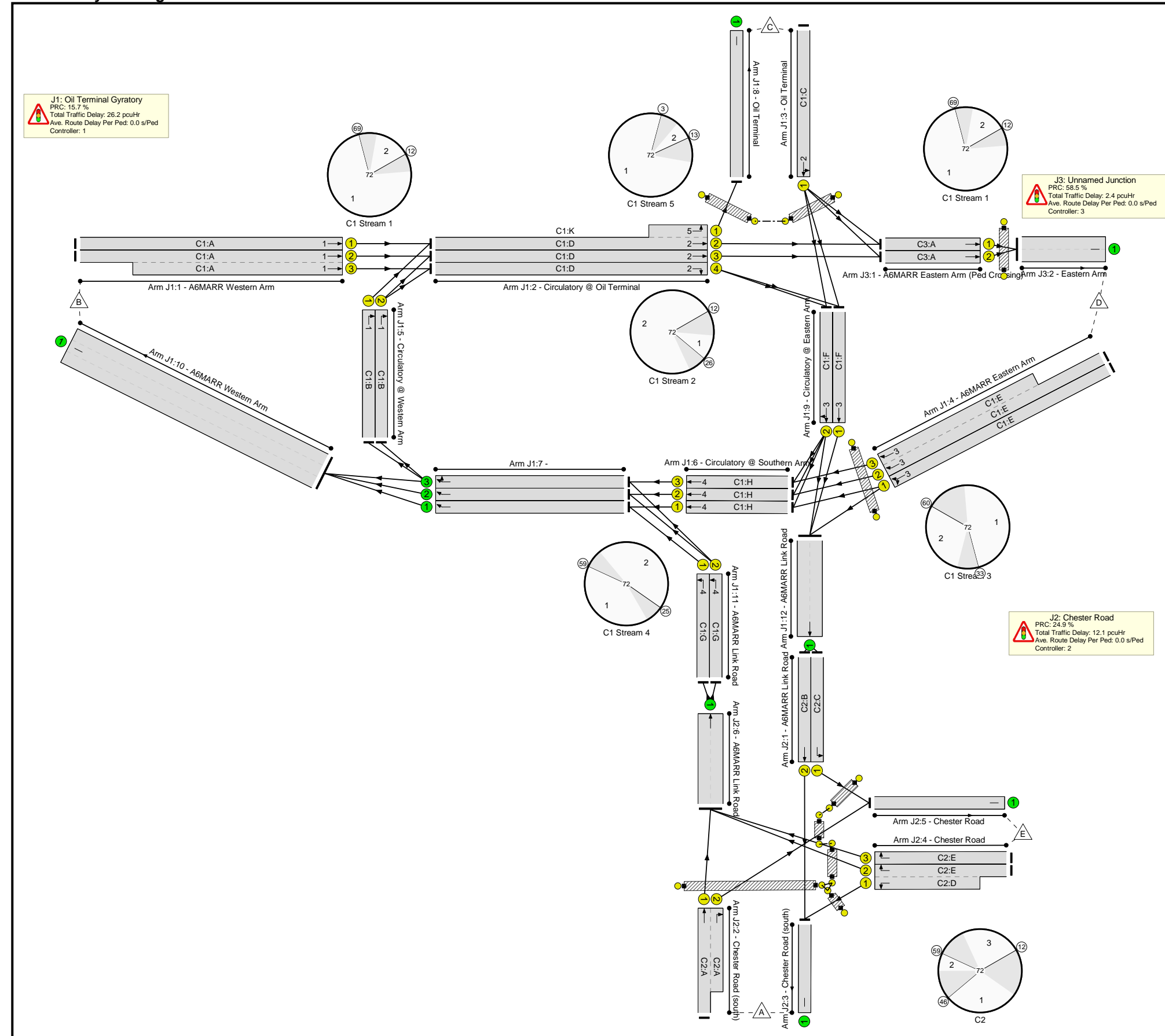

Network Results

Item	Lane Description	Lane Type	Controller Stream	Position In Filtered Route	Full Phase	Arrow Phase	Num Greens	Total Green (s)	Arrow Green (s)	Demand Flow (pcu)	Sat Flow (pcu/Hr)	Capacity (pcu)	Deg Sat (%)
Network: Oil Terminal Gyratory	-	-	N/A	-	-		-	-	-	-	-	-	77.8%
J1: Oil Terminal Gyratory	-	-	N/A	-	-		-	-	-	-	-	-	77.8%
1/1	A6MARR Western Arm Ahead	U	1:1	N/A	C1:A		1	52	-	854	1981	1458	58.6%
1/2+1/3	A6MARR Western Arm Ahead	U	1:1	N/A	C1:A		1	52	-	1593	2121:1981	1024+1025	77.8 : 77.8%
2/2+2/1	Circulatory @ Oil Terminal Left Ahead	U	1:2	N/A	C1:D C1:K		1	54:55	-	977	2015:1967	1501+31	63.8 : 63.8%
2/3	Circulatory @ Oil Terminal Ahead	U	1:2	N/A	C1:D		1	54	-	928	2015	1539	60.3%
2/4	Circulatory @ Oil Terminal Right	U	1:2	N/A	C1:D		1	54	-	797	2155	1646	48.4%
3/1	Oil Terminal Ahead Left	U	1:2	N/A	C1:C		1	7	-	20	1967	219	9.2%
4/1	A6MARR Eastern Arm Ahead Left	U	1:3	N/A	C1:E		1	34	-	325	1981	963	33.7%
4/2+4/3	A6MARR Eastern Arm Ahead	U	1:3	N/A	C1:E		1	34	-	814	2121:1981	1031+936	41.5 : 41.2%
5/1	Circulatory @ Western Arm Right	U	1:1	N/A	C1:B		1	10	-	123	2005	306	40.2%
5/2	Circulatory @ Western Arm Right	U	1:1	N/A	C1:B		1	10	-	132	1910	292	45.2%
6/1	Circulatory @ Southern Arm Ahead	U	1:4	N/A	C1:H		1	33	-	235	2015	952	24.7%
6/2	Circulatory @ Southern Arm Ahead	U	1:4	N/A	C1:H		1	33	-	429	2155	1018	42.2%
6/3	Circulatory @ Southern Arm Ahead	U	1:4	N/A	C1:H		1	33	-	387	2015	952	40.7%
7/1	Ahead	U	N/A	N/A	-		-	-	-	575	Inf	Inf	0.0%

Item	Lane Description	Lane Type	Controller Stream	Position In Filtered Route	Full Phase	Arrow Phase	Num Greens	Total Green (s)	Arrow Green (s)	Demand Flow (pcu)	Sat Flow (pcu/Hr)	Capacity (pcu)	Deg Sat (%)
7/2	Ahead	U	N/A	N/A	-		-	-	-	538	Inf	Inf	0.0%
7/3	Right Ahead	U	N/A	N/A	-		-	-	-	741	Inf	Inf	0.0%
8/1	Oil Terminal	U	N/A	N/A	-		-	-	-	20	Inf	Inf	0.0%
9/1	Circulatory @ Eastern Arm Ahead	U	1:3	N/A	C1:F		1	26	-	406	1942	728	55.8%
9/2	Circulatory @ Eastern Arm Right Ahead	U	1:3	N/A	C1:F		1	26	-	401	1932	725	55.3%
10/1	A6MARR Western Arm	U	N/A	N/A	-		-	-	-	1599	Inf	Inf	0.0%
11/1	A6MARR Link Road Left	U	1:4	N/A	C1:G		1	29	-	340	1990	829	41.0%
11/2	A6MARR Link Road Left	U	1:4	N/A	C1:G		1	29	-	463	2004	835	55.4%
12/1	A6MARR Link Road Ahead	U	N/A	N/A	-		-	-	-	895	Inf	Inf	0.0%
Ped Link: P1	Unnamed Ped Link	-	1:3	-	C1:J		1	22	-	0	-	0	0.0%
Ped Link: P2	Unnamed Ped Link	-	1:2	-	C1:I		1	53	-	0	-	0	0.0%
Ped Link: P3	Unnamed Ped Link	-	1:5	-	C1:L		1	5	-	0	-	0	0.0%
J2: Chester Road	-	-	N/A	-	-		-	-	-	-	-	-	72.1%
1/1	A6MARR Link Road Left	U	N/A	N/A	C2:C		1	39	-	777	1967	1093	71.1%
1/2	A6MARR Link Road Ahead	U	N/A	N/A	C2:B		1	8	-	118	2105	263	44.8%
2/1+2/2	Chester Road (south) Right Ahead	U	N/A	N/A	C2:A		1	21	-	682	1975:1839	384+562	72.1 : 72.1%
3/1	Chester Road (south)	U	N/A	N/A	-		-	-	-	404	Inf	Inf	0.0%
4/2+4/1	Chester Road Left Right	U	N/A	N/A	C2:E C2:D		1	24:52	-	601	1709:1967	593+539	53.1 : 53.1%
4/3	Chester Road Right	U	N/A	N/A	C2:E		1	24	-	211	1830	635	33.2%
5/1	Chester Road	U	N/A	N/A	-		-	-	-	1182	Inf	Inf	0.0%

Item	Lane Description	Lane Type	Controller Stream	Position In Filtered Route	Full Phase	Arrow Phase	Num Greens	Total Green (s)	Arrow Green (s)	Demand Flow (pcu)	Sat Flow (pcu/Hr)	Capacity (pcu)	Deg Sat (%)
6/1	A6MARR Link Road Ahead	U	N/A	N/A	-		-	-	-	803	Inf	Inf	0.0%
Ped Link: P1	Unnamed Ped Link	-	N/A	-	C2:F		1	21	-	0	-	0	0.0%
Ped Link: P2	Unnamed Ped Link	-	N/A	-	C2:G		1	36	-	0	-	0	0.0%
Ped Link: P3	Unnamed Ped Link	-	N/A	-	C2:H		1	35	-	0	-	0	0.0%
Ped Link: P4	Unnamed Ped Link	-	N/A	-	C2:J		1	17	-	0	-	0	0.0%
Ped Link: P5	Unnamed Ped Link	-	N/A	-	C2:I		1	8	-	0	-	0	0.0%
J3: Unnamed Junction	-	-	N/A	-	-		-	-	-	-	-	-	56.8%
1/1	A6MARR Eastern Arm (Ped Crossing) Ahead	U	N/A	N/A	C3:A		1	102	-	958	1965	1687	56.8%
1/2	A6MARR Eastern Arm (Ped Crossing) Ahead	U	N/A	N/A	C3:A		1	102	-	937	2105	1807	51.9%
2/1	Eastern Arm	U	N/A	N/A	-		-	-	-	1895	Inf	Inf	0.0%
Ped Link: P1	Unnamed Ped Link	-	N/A	-	C3:B		1	5	-	0	-	0	0.0%

Item	Arriving (pcu)	Leaving (pcu)	Turners In Gaps (pcu)	Turners When Unopposed (pcu)	Turners In Intergreen (pcu)	Uniform Delay (pcuHr)	Rand + Oversat Delay (pcuHr)	Storage Area Uniform Delay (pcuHr)	Total Delay (pcuHr)	Av. Delay Per PCU (s/pcu)	Max. Back of Uniform Queue (pcu)	Rand + Oversat Queue (pcu)	Mean Max Queue (pcu)
Network: Oil Terminal Gyratory	-	-	0	0	0	26.7	13.9	0.0	40.6	-	-	-	-
J1: Oil Terminal Gyratory	-	-	0	0	0	17.1	9.0	0.0	26.2	-	-	-	-
1/1	854	854	-	-	-	1.0	0.7	-	1.8	7.4	7.8	0.7	8.5
1/2+1/3	1593	1593	-	-	-	1.8	1.7	-	3.6	8.0	6.9	1.7	8.6
2/2+2/1	977	977	-	-	-	0.5	0.9	-	1.4	5.3	5.1	0.9	5.9
2/3	928	928	-	-	-	0.6	0.8	-	1.4	5.4	8.5	0.8	9.2
2/4	797	797	-	-	-	0.2	0.5	-	0.7	3.1	1.2	0.5	1.6
3/1	20	20	-	-	-	0.2	0.1	-	0.2	37.9	0.4	0.1	0.4
4/1	325	325	-	-	-	1.0	0.3	-	1.3	14.2	4.0	0.3	4.2
4/2+4/3	814	814	-	-	-	2.7	0.4	-	3.0	13.4	5.5	0.4	5.8
5/1	123	123	-	-	-	0.4	0.3	-	0.8	22.9	2.2	0.3	2.6
5/2	132	132	-	-	-	0.4	0.4	-	0.8	22.3	2.4	0.4	2.8
6/1	235	235	-	-	-	0.5	0.2	-	0.7	10.0	1.3	0.2	1.4
6/2	429	429	-	-	-	0.9	0.4	-	1.3	10.7	2.1	0.4	2.5
6/3	387	387	-	-	-	0.8	0.3	-	1.2	10.8	1.9	0.3	2.3
7/1	575	575	-	-	-	0.0	0.0	-	0.0	0.0	0.0	0.0	0.0
7/2	538	538	-	-	-	0.0	0.0	-	0.0	0.0	0.0	0.0	0.0
7/3	741	741	-	-	-	0.0	0.0	-	0.0	0.0	0.0	0.0	0.0
8/1	20	20	-	-	-	0.0	0.0	-	0.0	0.0	0.0	0.0	0.0
9/1	406	406	-	-	-	1.6	0.6	-	2.2	19.7	4.9	0.6	5.5
9/2	401	401	-	-	-	1.6	0.6	-	2.2	19.8	4.9	0.6	5.5

Item	Arriving (pcu)	Leaving (pcu)	Turners In Gaps (pcu)	Turners When Unopposed (pcu)	Turners In Intergreen (pcu)	Uniform Delay (pcuHr)	Rand + Oversat Delay (pcuHr)	Storage Area Uniform Delay (pcuHr)	Total Delay (pcuHr)	Av. Delay Per PCU (s/pcu)	Max. Back of Uniform Queue (pcu)	Rand + Oversat Queue (pcu)	Mean Max Queue (pcu)
10/1	1599	1599	-	-	-	0.0	0.0	-	0.0	0.0	0.0	0.0	0.0
11/1	340	340	-	-	-	1.6	0.3	-	1.9	20.5	6.2	0.3	6.6
11/2	463	463	-	-	-	1.2	0.6	-	1.8	13.9	5.1	0.6	5.7
12/1	895	895	-	-	-	0.0	0.0	-	0.0	0.0	0.0	0.0	0.0
Ped Link: P1	0	0	-	-	-	-	-	-	-	-	-	-	-
Ped Link: P2	0	0	-	-	-	-	-	-	-	-	-	-	-
Ped Link: P3	0	0	-	-	-	-	-	-	-	-	-	-	-
J2: Chester Road	-	-	0	0	0	8.4	3.7	0.0	12.1	-	-	-	-
1/1	777	777	-	-	-	0.4	1.2	-	1.6	7.6	13.9	1.2	15.1
1/2	118	118	-	-	-	1.0	0.4	-	1.4	42.2	2.2	0.4	2.6
2/1+2/2	682	682	-	-	-	4.1	1.3	-	5.3	28.2	7.2	1.3	8.5
3/1	404	404	-	-	-	0.0	0.0	-	0.0	0.0	0.0	0.0	0.0
4/2+4/1	601	601	-	-	-	1.9	0.6	-	2.4	14.6	5.0	0.6	5.6
4/3	211	211	-	-	-	1.0	0.2	-	1.3	21.6	3.1	0.2	3.4
5/1	1182	1182	-	-	-	0.0	0.0	-	0.0	0.0	0.0	0.0	0.0
6/1	803	803	-	-	-	0.0	0.0	-	0.0	0.0	0.0	0.0	0.0
Ped Link: P1	0	0	-	-	-	-	-	-	-	-	-	-	-
Ped Link: P2	0	0	-	-	-	-	-	-	-	-	-	-	-
Ped Link: P3	0	0	-	-	-	-	-	-	-	-	-	-	-
Ped Link: P4	0	0	-	-	-	-	-	-	-	-	-	-	-
Ped Link: P5	0	0	-	-	-	-	-	-	-	-	-	-	-
J3: Unnamed Junction	-	-	0	0	0	1.2	1.2	0.0	2.4	-	-	-	-

Item	Arriving (pcu)	Leaving (pcu)	Turners In Gaps (pcu)	Turners When Unopposed (pcu)	Turners In Intergreen (pcu)	Uniform Delay (pcuHr)	Rand + Oversat Delay (pcuHr)	Storage Area Uniform Delay (pcuHr)	Total Delay (pcuHr)	Av. Delay Per PCU (s/pcu)	Max. Back of Uniform Queue (pcu)	Rand + Oversat Queue (pcu)	Mean Max Queue (pcu)
1/1	958	958	-	-	-	0.6	0.7	-	1.3	4.8	8.8	0.7	9.4
1/2	937	937	-	-	-	0.6	0.5	-	1.1	4.2	7.8	0.5	8.3
2/1	1895	1895	-	-	-	0.0	0.0	-	0.0	0.0	0.0	0.0	0.0
Ped Link: P1	0	0	-	-	-	-	-	-	-	-	-	-	-
			C1	Stream: 1 PRC for Signalled Lanes (%)	15.7	Total Delay for Signalled Lanes (pcuHr):			6.90	Cycle Time (s):	72		
			C1	Stream: 2 PRC for Signalled Lanes (%)	41.1	Total Delay for Signalled Lanes (pcuHr):			3.71	Cycle Time (s):	72		
			C1	Stream: 3 PRC for Signalled Lanes (%)	61.4	Total Delay for Signalled Lanes (pcuHr):			8.74	Cycle Time (s):	72		
			C1	Stream: 4 PRC for Signalled Lanes (%)	62.3	Total Delay for Signalled Lanes (pcuHr):			6.80	Cycle Time (s):	72		
			C1	Stream: 5 PRC for Signalled Lanes (%)	0.0	Total Delay for Signalled Lanes (pcuHr):			0.00	Cycle Time (s):	72		
			C2	PRC for Signalled Lanes (%)	24.9	Total Delay for Signalled Lanes (pcuHr):			12.07	Cycle Time (s):	72		
			C3	PRC for Signalled Lanes (%)	58.5	Total Delay for Signalled Lanes (pcuHr):			2.38	Cycle Time (s):	120		
				PRC Over All Lanes (%)	15.7	Total Delay Over All Lanes (pcuHr):			40.61				

Appendix F.5

A6MARR/ A5102 Woodford Road LinSig Output

A6MARR / A5102 Woodford Road LinSig Output

Full Input Data And Results

User and Project Details

Project:	A6MARR
Title:	Woodford Road - A6MARR
Location:	
File name:	4 - A6MARR_Woodford Rd.lsg3x
Author:	GDC
Company:	Atkins
Address:	Bank Chambers, Faulkner Street, Manchester
Notes:	

Network Layout Diagram

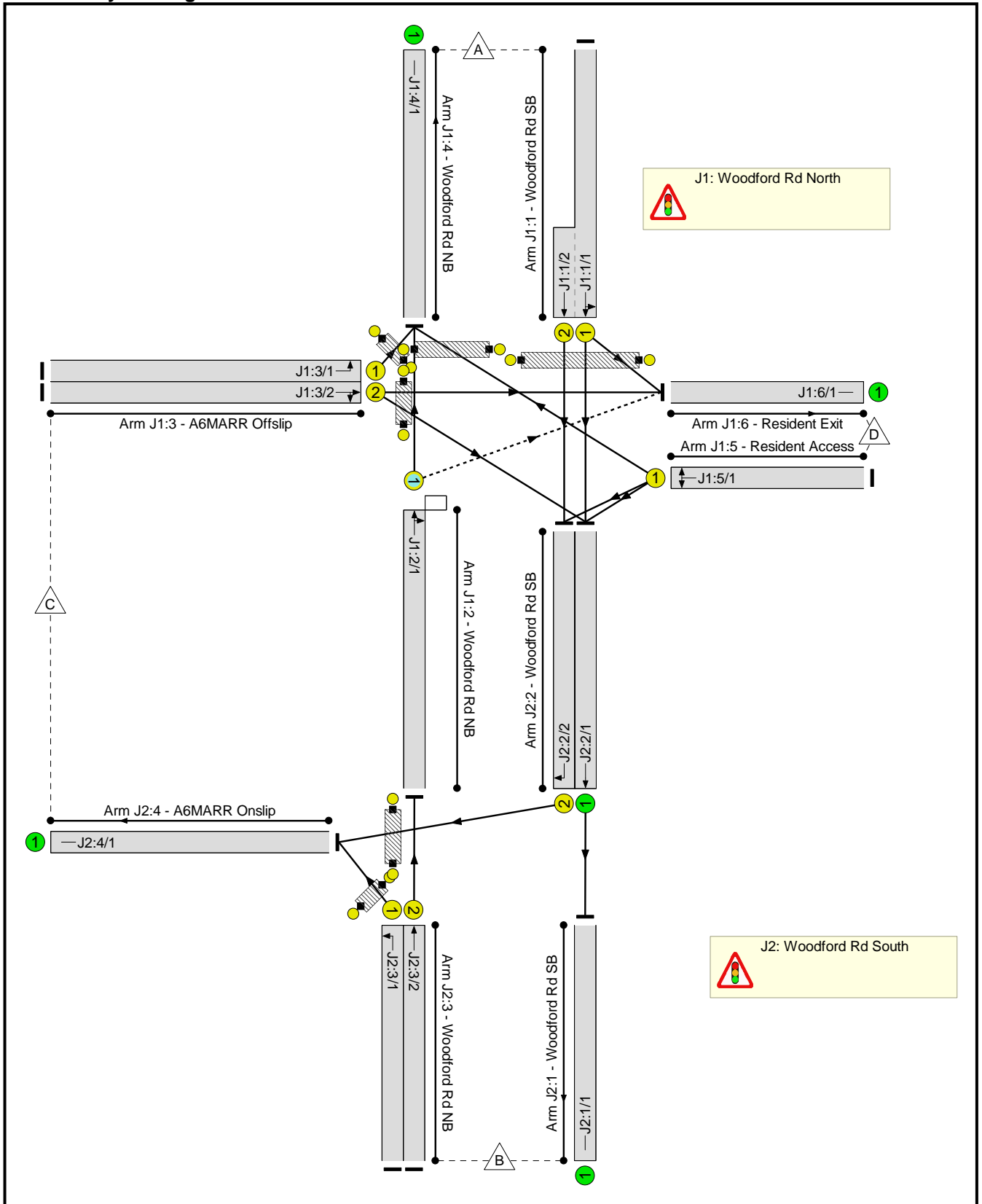

Phase Diagram

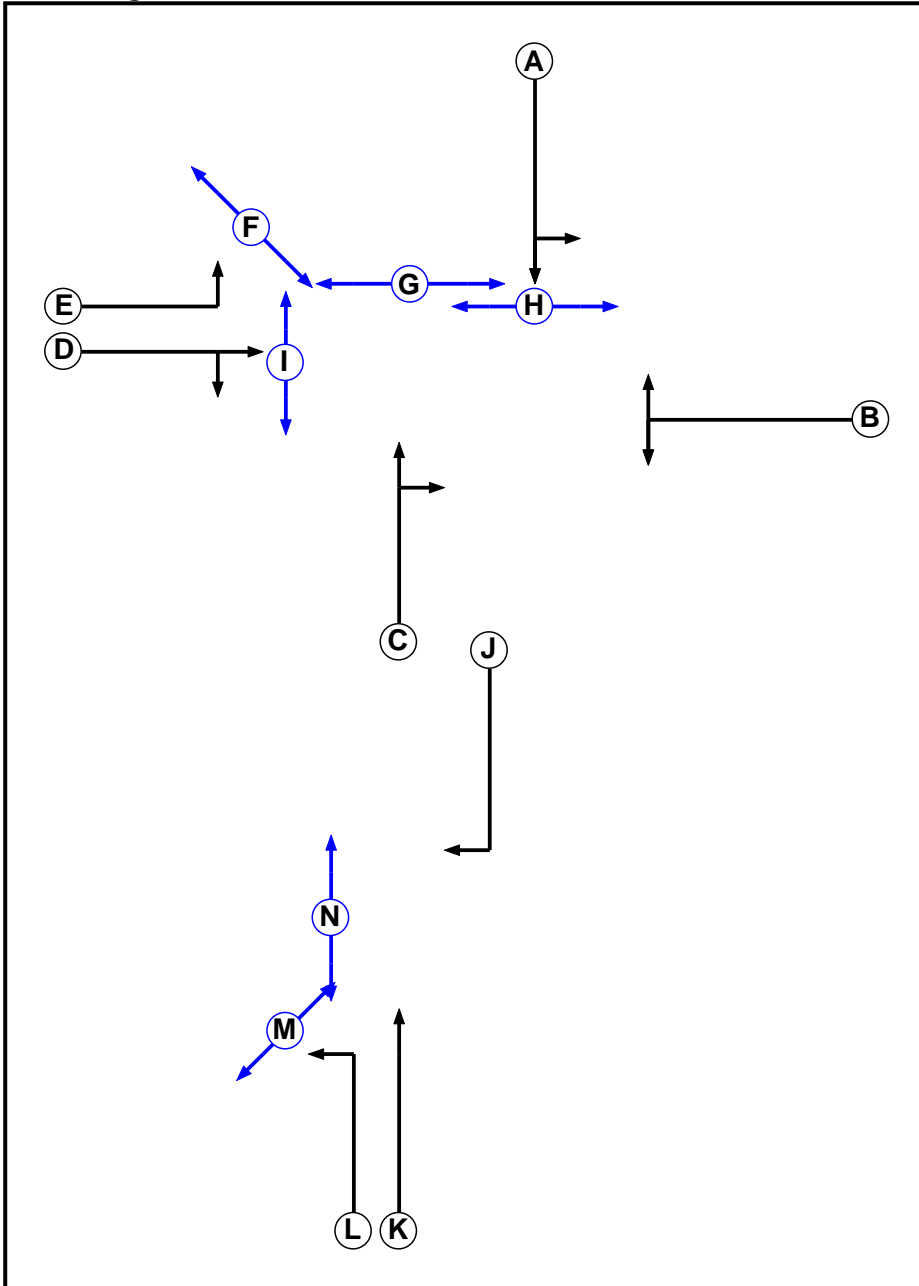

Phase Input Data

Phase Name	Phase Type	Stage Stream	Assoc. Phase	Street Min	Cont Min
A	Traffic	1		7	7
B	Traffic	1		7	7
C	Traffic	1		7	6
D	Traffic	1		7	7
E	Traffic	1		7	5
F	Pedestrian	1		5	5
G	Pedestrian	1		5	5
H	Pedestrian	1		5	5
I	Pedestrian	1		5	5
J	Traffic	2		7	6
K	Traffic	2		7	4
L	Traffic	2		7	4
M	Pedestrian	2		5	5
N	Pedestrian	2		5	5

Phase Intergreens Matrix

	Starting Phase													
	A	B	C	D	E	F	G	H	I	J	K	L	M	N
Terminating Phase	A	6	-	5	-	-	-	5	-	-	-	-	-	-
	B	5	6	6	7	-	8	-	-	-	-	-	-	-
	C	-	5	5	6	-	7	-	-	-	-	-	-	-
	D	6	7	5	-	-	-	-	5	-	-	-	-	-
	E	-	5	5	-	-	5	-	-	-	-	-	-	-
	F	-	-	-	-	7	-	-	-	-	-	-	-	-
	G	-	7	7	-	-	-	-	-	-	-	-	-	-
	H	8	-	-	-	-	-	-	-	-	-	-	-	-
	I	-	-	-	6	-	-	-	-	-	-	-	-	-
	J	-	-	-	-	-	-	-	-	-	5	6	-	7
	K	-	-	-	-	-	-	-	-	5	-	-	-	-
	L	-	-	-	-	-	-	-	-	5	-	-	5	-
	M	-	-	-	-	-	-	-	-	-	-	7	-	-
	N	-	-	-	-	-	-	-	-	8	-	-	-	-

Phases in Stage

Stream	Stage No.	Phases in Stage
1	1	D E G H
1	2	A E G I
1	3	A C F I
1	4	B F H I
2	1	J M
2	2	K L N

Stage Diagram

Stage Stream: 1

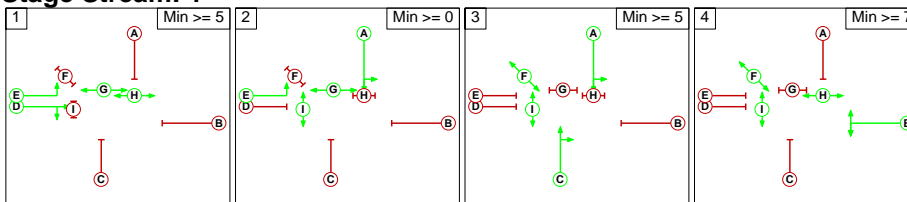

Stage Stream: 2

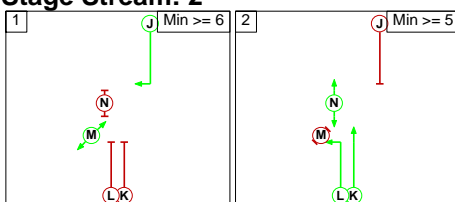

Phase Delays
Stage Stream: 1

Term. Stage	Start Stage	Phase	Type	Value	Cont value
1	2	D	Losing	2	2
1	3	D	Losing	2	2
1	3	E	Losing	2	2
1	4	E	Losing	2	2
2	1	A	Losing	1	1
2	3	E	Losing	2	2
2	4	A	Losing	1	1
2	4	E	Losing	2	2
3	1	A	Losing	1	1
3	1	C	Losing	1	1
3	2	C	Losing	1	1
3	4	C	Losing	1	1
4	2	B	Losing	3	3
4	2	F	Losing	3	3
4	3	B	Losing	3	3

Stage Stream: 2

Term. Stage	Start Stage	Phase	Type	Value	Cont value
1	2	J	Losing	1	1
2	1	K	Losing	3	3
2	1	L	Losing	3	3

Prohibited Stage Change
Stage Stream: 1

		To Stage			
		1	2	3	4
From Stage	1		8	8	7
	2	6		7	7
	3	8	8		6
	4	8	11	9	

Stage Stream: 2

		To Stage	
		1	2
From Stage	1		8
	2	8	

Give-Way Lane Input Data

Junction: J1: Woodford Rd North											
Lane	Movement	Max Flow when Giving Way (PCU/Hr)	Min Flow when Giving Way (PCU/Hr)	Opposing Lane	Opp. Lane Coeff.	Opp. Mvmnts.	Right Turn Storage (PCU)	Non-Blocking Storage (PCU)	RTF	Right Turn Move up (s)	Max Turns in Intergreen (PCU)
J1:2/1 (Woodford Rd NB)	J1:6/1 (Right)	1440	0	J1:1/1	0.50	All	1.00	1.00	0.50	1	2.00
				J1:1/2	0.50	All					

Junction: J2: Woodford Rd South
There are no Opposed Lanes in this Junction

Lane Input Data

Junction: J1: Woodford Rd North												
Lane	Lane Type	Phases	Start Disp.	End Disp.	Physical Length (PCU)	Sat Flow Type	Def User Saturation Flow (PCU/Hr)	Lane Width (m)	Gradient	Nearside Lane	Turns	Turning Radius (m)
J1:1/1 (Woodford Rd SB)	U	A	2	3	60.0	Geom	-	3.75	0.00	Y	Arm J2:2 Ahead	100.00
J1:1/2 (Woodford Rd SB)	U	A	2	3	6.3	Geom	-	3.75	0.00	N	Arm J1:6 Left	5.00
J1:2/1 (Woodford Rd NB)	O	C	2	3	13.9	Geom	-	4.50	0.00	Y	Arm J2:2 Ahead	100.00
J1:3/1 (A6MARR Offslip)	U	E	2	3	60.0	Geom	-	5.00	0.00	Y	Arm J1:4 Left	30.00
J1:3/2 (A6MARR Offslip)	U	D	2	3	60.0	Geom	-	3.75	0.00	Y	Arm J2:2 Right	25.00
J1:4/1 (Woodford Rd NB)	U		2	3	60.0	Inf	-	-	-	-	Arm J1:6 Ahead	Inf
J1:5/1 (Resident Access)	U	B	2	3	5.8	Geom	-	3.00	0.00	Y	Arm J1:4 Right	15.00
J1:6/1 (Resident Exit)	U		2	3	60.0	Inf	-	-	-	-	Arm J2:2 Left	5.00

Junction: J2: Woodford Rd South												
Lane	Lane Type	Phases	Start Disp.	End Disp.	Physical Length (PCU)	Sat Flow Type	Def User Saturation Flow (PCU/Hr)	Lane Width (m)	Gradient	Nearside Lane	Turns	Turning Radius (m)
J2:1/1 (Woodford Rd SB)	U		2	3	60.0	Inf	-	-	-	-	-	-
J2:2/1 (Woodford Rd SB)	U		2	3	14.8	Inf	-	-	-	-	-	-
J2:2/2 (Woodford Rd SB)	U	J	2	3	12.2	Geom	-	3.50	0.00	Y	Arm J2:4 Right	20.00
J2:3/1 (Woodford Rd NB)	U	L	2	3	60.0	Geom	-	5.00	0.00	Y	Arm J2:4 Left	30.00
J2:3/2 (Woodford Rd NB)	U	K	2	3	60.0	Geom	-	4.50	0.00	Y	Arm J1:2 Ahead	100.00
J2:4/1 (A6MARR Onslip)	U		2	3	60.0	Inf	-	-	-	-	-	-

Traffic Flow Groups

Flow Group	Start Time	End Time	Duration	Formula
1: 'AM 2017'	08:00	09:00	01:00	
2: 'PM 2017'	16:30	17:30	01:00	

Scenario 1: 'AM 2017' (FG1: 'AM 2017', Plan 1: 'Network Control Plan 1')

Traffic Flows, Desired

Desired Flow :

	Destination					
	A	B	C	D	Tot.	
Origin	A	0	492	688	1	1181
	B	432	0	115	1	548
	C	409	66	0	1	476
	D	1	1	1	0	3
	Tot.	842	559	804	3	2208

Traffic Lane Flows

Lane	Scenario 1: AM 2017
Junction: J1: Woodford Rd North	
J1:1/1 (with short)	1181(In) 493(Out)
J1:1/2 (short)	688
J1:2/1	433
J1:3/1	409
J1:3/2	67
J1:4/1	842
J1:5/1	3
J1:6/1	3
Junction: J2: Woodford Rd South	
J2:1/1	559
J2:2/1	559
J2:2/2	689
J2:3/1	115
J2:3/2	433
J2:4/1	804

Lane Saturation Flows

Junction: J1: Woodford Rd North								
Lane	Lane Width (m)	Gradient	Nearside Lane	Allowed Turns	Turning Radius (m)	Turning Prop.	Sat Flow (PCU/Hr)	Flared Sat Flow (PCU/Hr)
J1:1/1 (Woodford Rd SB)	3.75	0.00	Y	Arm J2:2 Ahead	100.00	99.8 %	1959	1959
				Arm J1:6 Left	5.00	0.2 %		
J1:1/2 (Woodford Rd SB)	3.75	0.00	N	Arm J2:2 Ahead	100.00	100.0 %	2099	2099
J1:2/1 (Woodford Rd NB)	4.50	0.00	Y	Arm J1:4 Ahead	100.00	99.8 %	2033	2033
				Arm J1:6 Right	5.00	0.2 %		
J1:3/1 (A6MARR Offslip)	5.00	0.00	Y	Arm J1:4 Left	30.00	100.0 %	2014	2014
J1:3/2 (A6MARR Offslip)	3.75	0.00	Y	Arm J2:2 Right	25.00	98.5 %	1879	1879
				Arm J1:6 Ahead	Inf	1.5 %		
J1:4/1 (Woodford Rd NB Lane 1)	Infinite Saturation Flow						Inf	Inf
J1:5/1 (Resident Access)	3.00	0.00	Y	Arm J2:2 Left	5.00	66.7 %	1553	1553
				Arm J1:4 Right	15.00	33.3 %		
J1:6/1 (Resident Exit Lane 1)	Infinite Saturation Flow						Inf	Inf

Junction: J2: Woodford Rd South								
Lane	Lane Width (m)	Gradient	Nearside Lane	Allowed Turns	Turning Radius (m)	Turning Prop.	Sat Flow (PCU/Hr)	Flared Sat Flow (PCU/Hr)
J2:1/1 (Woodford Rd SB Lane 1)	Infinite Saturation Flow						Inf	Inf
J2:2/1 (Woodford Rd SB Lane 1)	Infinite Saturation Flow						Inf	Inf
J2:2/2 (Woodford Rd SB)	3.50	0.00	Y	Arm J2:4 Right	20.00	100.0 %	1828	1828
J2:3/1 (Woodford Rd NB)	5.00	0.00	Y	Arm J2:4 Left	30.00	100.0 %	2014	2014
J2:3/2 (Woodford Rd NB)	4.50	0.00	Y	Arm J1:2 Ahead	100.00	100.0 %	2034	2034
J2:4/1 (A6MARR Onslip Lane 1)	Infinite Saturation Flow						Inf	Inf

Scenario 2: 'PM 2017' (FG2: 'PM 2017', Plan 1: 'Network Control Plan 1')

Traffic Flows, Desired

Desired Flow :

	Destination					
	A	B	C	D	Tot.	
Origin	A	0	432	292	1	725
	B	549	0	67	1	617
	C	704	85	0	1	790
	D	1	1	1	0	3
	Tot.	1254	518	360	3	2135

Traffic Lane Flows

Lane	Scenario 2: PM 2017
Junction: J1: Woodford Rd North	
J1:1/1 (with short)	725(In) 433(Out)
J1:1/2 (short)	292
J1:2/1	550
J1:3/1	704
J1:3/2	86
J1:4/1	1254
J1:5/1	3
J1:6/1	3
Junction: J2: Woodford Rd South	
J2:1/1	518
J2:2/1	518
J2:2/2	293
J2:3/1	67
J2:3/2	550
J2:4/1	360

Lane Saturation Flows

Junction: J1: Woodford Rd North								
Lane	Lane Width (m)	Gradient	Nearside Lane	Allowed Turns	Turning Radius (m)	Turning Prop.	Sat Flow (PCU/Hr)	Flared Sat Flow (PCU/Hr)
J1:1/1 (Woodford Rd SB)	3.75	0.00	Y	Arm J2:2 Ahead	100.00	99.8 %	1959	1959
				Arm J1:6 Left	5.00	0.2 %		
J1:1/2 (Woodford Rd SB)	3.75	0.00	N	Arm J2:2 Ahead	100.00	100.0 %	2099	2099
J1:2/1 (Woodford Rd NB)	4.50	0.00	Y	Arm J1:4 Ahead	100.00	99.8 %	2033	2033
				Arm J1:6 Right	5.00	0.2 %		
J1:3/1 (A6MARR Offslip)	5.00	0.00	Y	Arm J1:4 Left	30.00	100.0 %	2014	2014
J1:3/2 (A6MARR Offslip)	3.75	0.00	Y	Arm J2:2 Right	25.00	98.8 %	1879	1879
				Arm J1:6 Ahead	Inf	1.2 %		
J1:4/1 (Woodford Rd NB Lane 1)	Infinite Saturation Flow						Inf	Inf
J1:5/1 (Resident Access)	3.00	0.00	Y	Arm J2:2 Left	5.00	66.7 %	1553	1553
				Arm J1:4 Right	15.00	33.3 %		
J1:6/1 (Resident Exit Lane 1)	Infinite Saturation Flow						Inf	Inf

Junction: J2: Woodford Rd South								
Lane	Lane Width (m)	Gradient	Nearside Lane	Allowed Turns	Turning Radius (m)	Turning Prop.	Sat Flow (PCU/Hr)	Flared Sat Flow (PCU/Hr)
J2:1/1 (Woodford Rd SB Lane 1)	Infinite Saturation Flow						Inf	Inf
J2:2/1 (Woodford Rd SB Lane 1)	Infinite Saturation Flow						Inf	Inf
J2:2/2 (Woodford Rd SB)	3.50	0.00	Y	Arm J2:4 Right	20.00	100.0 %	1828	1828
J2:3/1 (Woodford Rd NB)	5.00	0.00	Y	Arm J2:4 Left	30.00	100.0 %	2014	2014
J2:3/2 (Woodford Rd NB)	4.50	0.00	Y	Arm J1:2 Ahead	100.00	100.0 %	2034	2034
J2:4/1 (A6MARR Onslip Lane 1)	Infinite Saturation Flow						Inf	Inf

Scenario 1: 'AM 2017' (FG1: 'AM 2017', Plan 1: 'Network Control Plan 1')

Stage Sequence Diagram

Stage Stream: 1

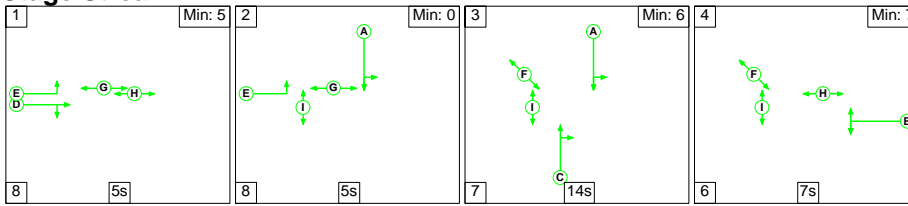

Stage Stream: 2

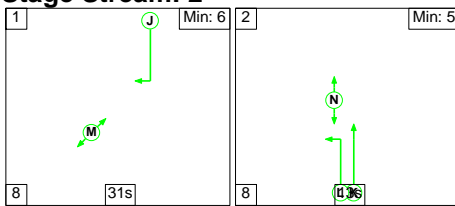

Stage Timings

Stage Stream: 1

Stage	1	2	3	4
Duration	5	5	14	7
Change Point	41	54	7	28

Stage Stream: 2

Stage	1	2
Duration	31	13
Change Point	58	37

Signal Timings Diagram

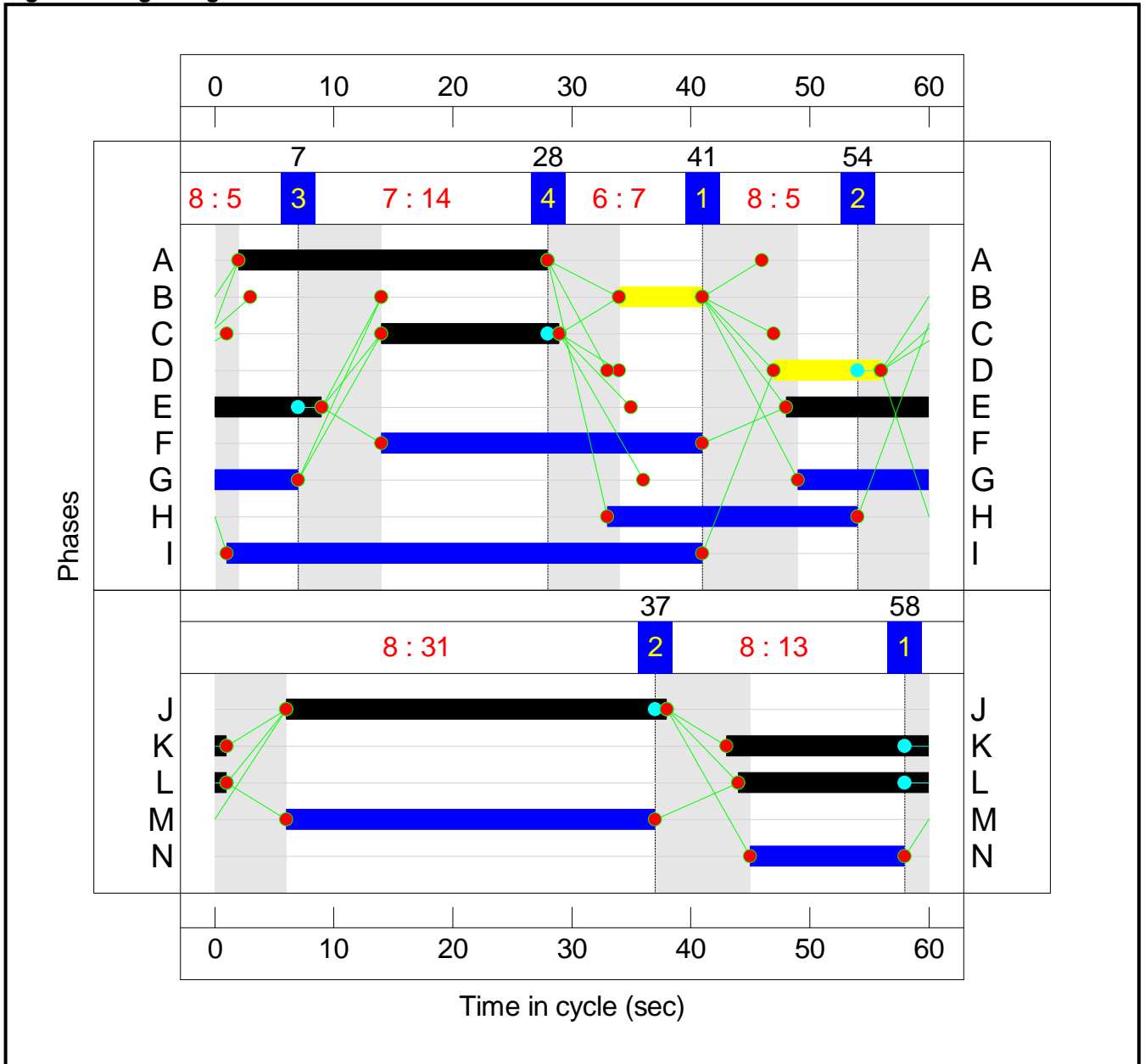

Network Layout Diagram

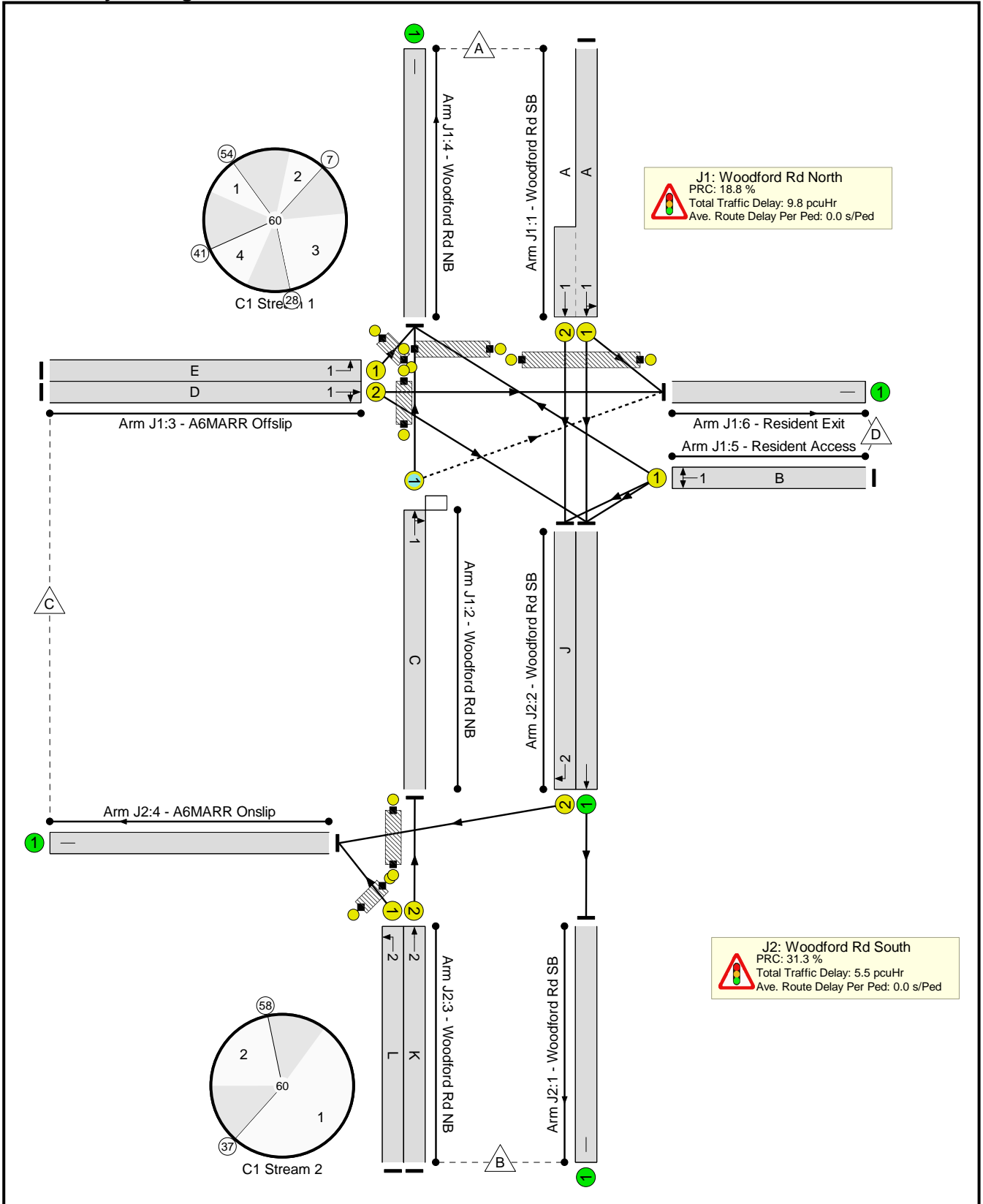

Network Results

Item	Lane Description	Lane Type	Controller Stream	Position In Filtered Route	Full Phase	Arrow Phase	Num Greens	Total Green (s)	Arrow Green (s)	Demand Flow (pcu)	Sat Flow (pcu/Hr)	Capacity (pcu)	Deg Sat (%)
Network: Woodford Road - A6MARR	-	-	N/A	-	-		-	-	-	-	-	-	75.7%
J1: Woodford Rd North	-	-	N/A	-	-		-	-	-	-	-	-	75.7%
1/1+1/2	Woodford Rd SB Ahead Left	U	1	N/A	A		1	26	-	1181	1959:2099	651+908	75.7 : 75.7%
2/1	Woodford Rd NB Ahead Right	O	1	N/A	C		1	15	-	433	2033	847	51.1%
3/1	A6MARR Offslip Left	U	1	N/A	E		1	21	-	409	2014	738	55.4%
3/2	A6MARR Offslip Right Ahead	U	1	N/A	D		1	9	-	67	1879	313	21.4%
4/1	Woodford Rd NB	U	N/A	N/A	-		-	-	-	842	Inf	Inf	0.0%
5/1	Resident Access Left Right	U	1	N/A	B		1	7	-	3	1553	52	5.8%
6/1	Resident Exit	U	N/A	N/A	-		-	-	-	3	Inf	Inf	0.0%
Ped Link: P1	Unnamed Ped Link	-	1	-	F		1	27	-	0	-	0	0.0%
Ped Link: P2	Unnamed Ped Link	-	1	-	G		1	18	-	0	-	0	0.0%
Ped Link: P3	Unnamed Ped Link	-	1	-	H		1	21	-	0	-	0	0.0%
Ped Link: P4	Unnamed Ped Link	-	1	-	I		1	40	-	0	-	0	0.0%
J2: Woodford Rd South	-	-	N/A	-	-		-	-	-	-	-	-	68.5%
1/1	Woodford Rd SB	U	N/A	N/A	-		-	-	-	559	Inf	Inf	0.0%
2/1	Woodford Rd SB Ahead	U	N/A	N/A	-		-	-	-	559	Inf	Inf	0.0%
2/2	Woodford Rd SB Right	U	2	N/A	J		1	32	-	689	1828	1005	68.5%

Item	Lane Description	Lane Type	Controller Stream	Position In Filtered Route	Full Phase	Arrow Phase	Num Greens	Total Green (s)	Arrow Green (s)	Demand Flow (pcu)	Sat Flow (pcu/Hr)	Capacity (pcu)	Deg Sat (%)
3/1	Woodford Rd NB Left	U	2	N/A	L		1	17	-	115	2014	604	19.0%
3/2	Woodford Rd NB Ahead	U	2	N/A	K		1	18	-	433	2034	644	67.2%
4/1	A6MARR Onslip	U	N/A	N/A	-		-	-	-	804	Inf	Inf	0.0%
Ped Link: P1	Unnamed Ped Link	-	2	-	M		1	31	-	0	-	0	0.0%
Ped Link: P2	Unnamed Ped Link	-	2	-	N		1	13	-	0	-	0	0.0%

Item	Arriving (pcu)	Leaving (pcu)	Turners In Gaps (pcu)	Turners When Unopposed (pcu)	Turners In Intergreen (pcu)	Uniform Delay (pcuHr)	Rand + Oversat Delay (pcuHr)	Storage Area Uniform Delay (pcuHr)	Total Delay (pcuHr)	Av. Delay Per PCU (s/pcu)	Max. Back of Uniform Queue (pcu)	Rand + Oversat Queue (pcu)	Mean Max Queue (pcu)
Network: Woodford Road - A6MARR	-	-	1	0	0	10.2	5.1	0.0	15.3	-	-	-	-
J1: Woodford Rd North	-	-	1	0	0	6.9	2.9	0.0	9.8	-	-	-	-
1/1+1/2	1181	1181	-	-	-	2.1	1.5	-	3.6	11.0	6.6	1.5	8.2
2/1	433	433	1	0	0	2.7	0.5	0.0	3.2	26.8	7.2	0.5	7.7
3/1	409	409	-	-	-	1.7	0.6	-	2.3	20.5	5.3	0.6	6.0
3/2	67	67	-	-	-	0.4	0.1	-	0.5	28.9	0.9	0.1	1.1
4/1	842	842	-	-	-	0.0	0.0	-	0.0	0.0	0.0	0.0	0.0
5/1	3	3	-	-	-	0.0	0.0	-	0.1	65.4	0.0	0.0	0.1
6/1	3	3	-	-	-	0.0	0.0	-	0.0	0.0	0.0	0.0	0.0
Ped Link: P1	0	0	-	-	-	-	-	-	-	-	-	-	-
Ped Link: P2	0	0	-	-	-	-	-	-	-	-	-	-	-
Ped Link: P3	0	0	-	-	-	-	-	-	-	-	-	-	-
Ped Link: P4	0	0	-	-	-	-	-	-	-	-	-	-	-
J2: Woodford Rd South	-	-	0	0	0	3.3	2.2	0.0	5.5	-	-	-	-
1/1	559	559	-	-	-	0.0	0.0	-	0.0	0.0	0.0	0.0	0.0
2/1	559	559	-	-	-	0.0	0.0	-	0.0	0.0	0.0	0.0	0.0
2/2	689	689	-	-	-	0.7	1.1	-	1.7	9.1	4.2	1.1	5.3
3/1	115	115	-	-	-	0.5	0.1	-	0.6	19.3	1.4	0.1	1.5
3/2	433	433	-	-	-	2.1	1.0	-	3.2	26.2	6.3	1.0	7.3
4/1	804	804	-	-	-	0.0	0.0	-	0.0	0.0	0.0	0.0	0.0

Item	Arriving (pcu)	Leaving (pcu)	Turners In Gaps (pcu)	Turners When Unopposed (pcu)	Turners In Intergreen (pcu)	Uniform Delay (pcuHr)	Rand + Oversat Delay (pcuHr)	Storage Area Uniform Delay (pcuHr)	Total Delay (pcuHr)	Av. Delay Per PCU (s/pcu)	Max. Back of Uniform Queue (pcu)	Rand + Oversat Queue (pcu)	Mean Max Queue (pcu)	
Ped Link: P1	0	0	-	-	-	-	-	-	-	-	-	-	-	
Ped Link: P2	0	0	-	-	-	-	-	-	-	-	-	-	-	
			C1	Stream: 1 PRC for Signalled Lanes (%)	18.8	Total Delay for Signalled Lanes (pcuHr):			9.76	Cycle Time (s):		60		
			C1	Stream: 2 PRC for Signalled Lanes (%)	31.3	Total Delay for Signalled Lanes (pcuHr):			5.51	Cycle Time (s):		60		
				PRC Over All Lanes (%)	18.8	Total Delay Over All Lanes (pcuHr):			15.27					

Scenario 2: 'PM 2017' (FG2: 'PM 2017', Plan 1: 'Network Control Plan 1')

Stage Sequence Diagram

Stage Stream: 1

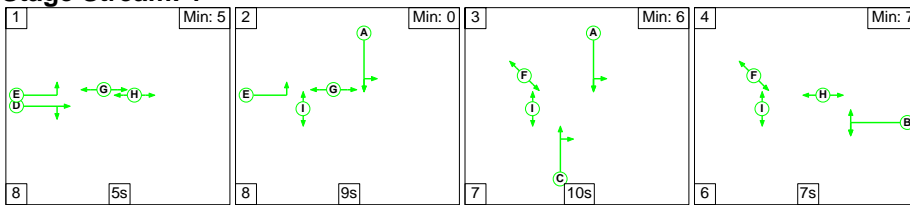

Stage Stream: 2

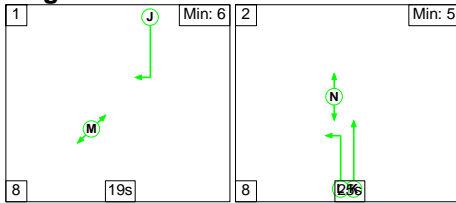

Stage Timings

Stage Stream: 1

Stage	1	2	3	4
Duration	5	9	10	7
Change Point	0	13	30	47

Stage Stream: 2

Stage	1	2
Duration	19	25
Change Point	4	31

Signal Timings Diagram

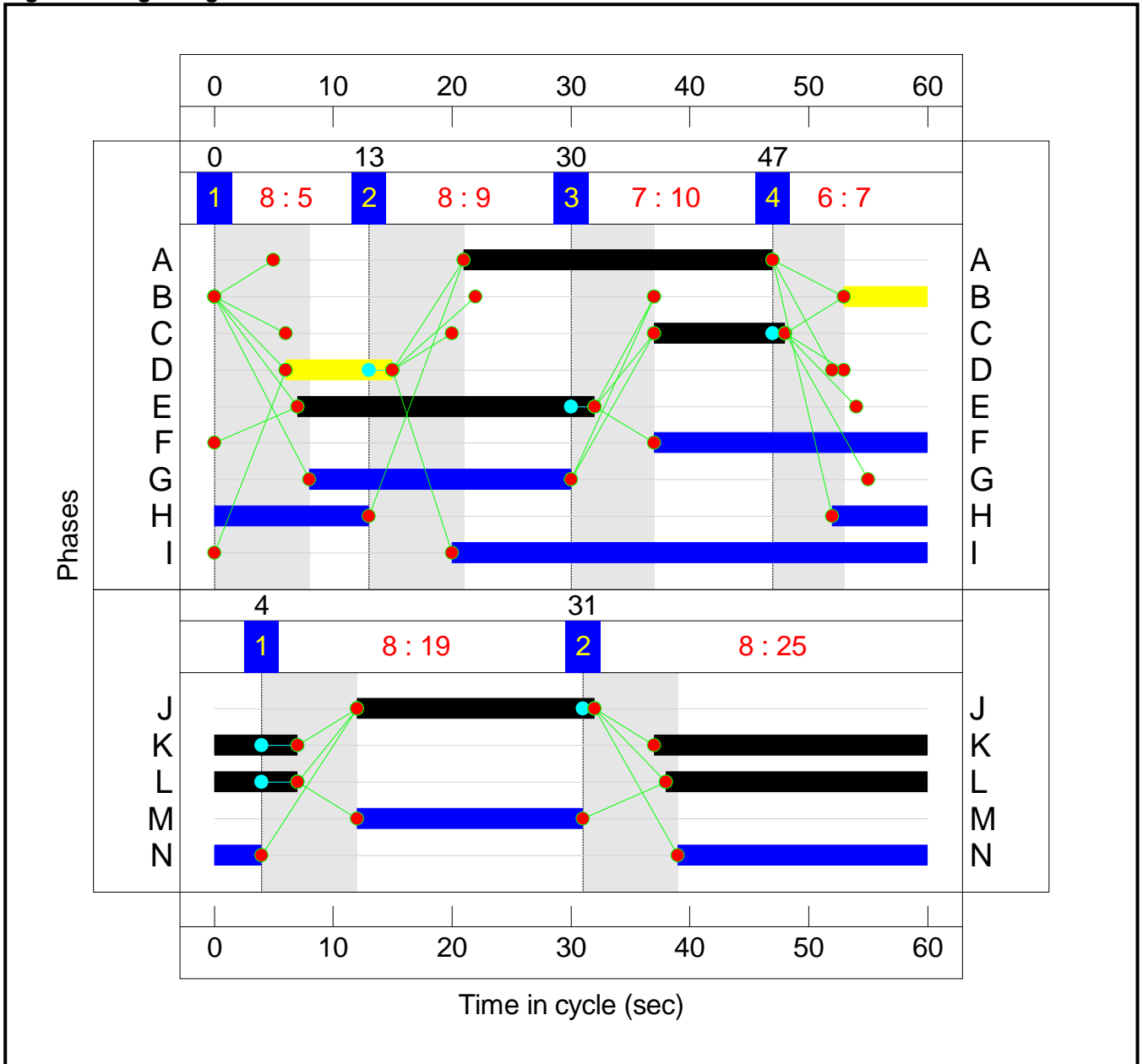

Network Layout Diagram

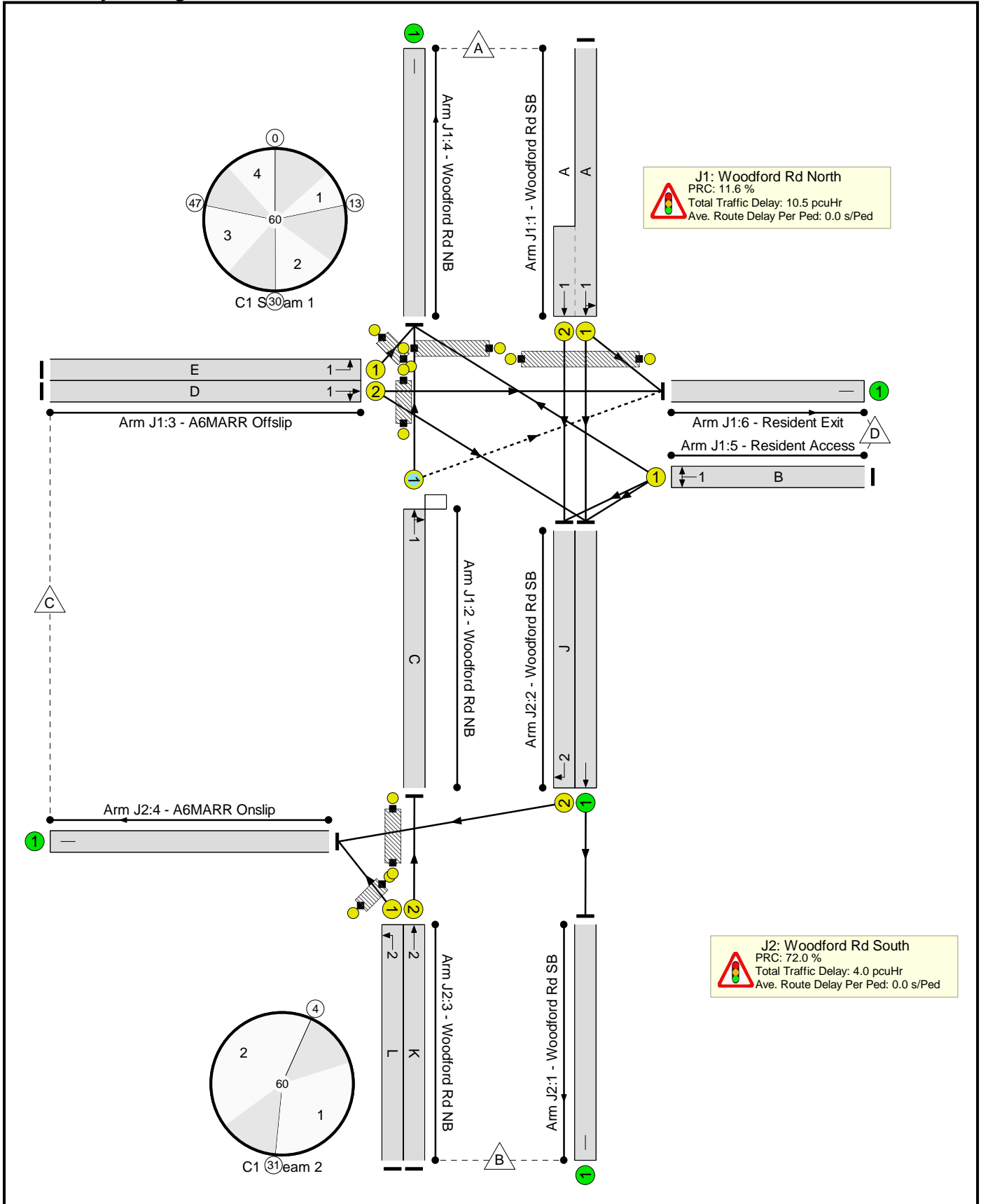

Network Results

Item	Lane Description	Lane Type	Controller Stream	Position In Filtered Route	Full Phase	Arrow Phase	Num Greens	Total Green (s)	Arrow Green (s)	Demand Flow (pcu)	Sat Flow (pcu/Hr)	Capacity (pcu)	Deg Sat (%)
Network: Woodford Road - A6MARR	-	-	N/A	-	-		-	-	-	-	-	-	80.7%
J1: Woodford Rd North	-	-	N/A	-	-		-	-	-	-	-	-	80.7%
1/1+1/2	Woodford Rd SB Ahead Left	U	1	N/A	A		1	26	-	725	1959:2099	895+603	48.4 : 48.4%
2/1	Woodford Rd NB Ahead Right	O	1	N/A	C		1	11	-	550	2033	712	77.3%
3/1	A6MARR Offslip Left	U	1	N/A	E		1	25	-	704	2014	873	80.7%
3/2	A6MARR Offslip Right Ahead	U	1	N/A	D		1	9	-	86	1879	313	27.5%
4/1	Woodford Rd NB	U	N/A	N/A	-		-	-	-	1254	Inf	Inf	0.0%
5/1	Resident Access Left Right	U	1	N/A	B		1	7	-	3	1553	52	5.8%
6/1	Resident Exit	U	N/A	N/A	-		-	-	-	3	Inf	Inf	0.0%
Ped Link: P1	Unnamed Ped Link	-	1	-	F		1	23	-	0	-	0	0.0%
Ped Link: P2	Unnamed Ped Link	-	1	-	G		1	22	-	0	-	0	0.0%
Ped Link: P3	Unnamed Ped Link	-	1	-	H		1	21	-	0	-	0	0.0%
Ped Link: P4	Unnamed Ped Link	-	1	-	I		1	40	-	0	-	0	0.0%
J2: Woodford Rd South	-	-	N/A	-	-		-	-	-	-	-	-	52.3%
1/1	Woodford Rd SB	U	N/A	N/A	-		-	-	-	518	Inf	Inf	0.0%
2/1	Woodford Rd SB Ahead	U	N/A	N/A	-		-	-	-	518	Inf	Inf	0.0%
2/2	Woodford Rd SB Right	U	2	N/A	J		1	20	-	293	1828	640	45.8%

Item	Lane Description	Lane Type	Controller Stream	Position In Filtered Route	Full Phase	Arrow Phase	Num Greens	Total Green (s)	Arrow Green (s)	Demand Flow (pcu)	Sat Flow (pcu/Hr)	Capacity (pcu)	Deg Sat (%)
3/1	Woodford Rd NB Left	U	2	N/A	L		1	29	-	67	2014	1007	6.7%
3/2	Woodford Rd NB Ahead	U	2	N/A	K		1	30	-	550	2034	1051	52.3%
4/1	A6MARR Onslip	U	N/A	N/A	-		-	-	-	360	Inf	Inf	0.0%
Ped Link: P1	Unnamed Ped Link	-	2	-	M		1	19	-	0	-	0	0.0%
Ped Link: P2	Unnamed Ped Link	-	2	-	N		1	25	-	0	-	0	0.0%

Item	Arriving (pcu)	Leaving (pcu)	Turners In Gaps (pcu)	Turners When Unopposed (pcu)	Turners In Intergreen (pcu)	Uniform Delay (pcuHr)	Rand + Oversat Delay (pcuHr)	Storage Area Uniform Delay (pcuHr)	Total Delay (pcuHr)	Av. Delay Per PCU (s/pcu)	Max. Back of Uniform Queue (pcu)	Rand + Oversat Queue (pcu)	Mean Max Queue (pcu)
Network: Woodford Road - A6MARR	-	-	1	0	0	9.1	5.4	0.0	14.5	-	-	-	-
J1: Woodford Rd North	-	-	1	0	0	6.1	4.4	0.0	10.5	-	-	-	-
1/1+1/2	725	725	-	-	-	1.1	0.5	-	1.6	7.8	3.5	0.5	4.0
2/1	550	550	1	0	0	1.6	1.7	0.0	3.3	21.4	2.9	1.7	4.6
3/1	704	704	-	-	-	2.9	2.0	-	4.9	25.2	10.2	2.0	12.2
3/2	86	86	-	-	-	0.5	0.2	-	0.7	29.8	1.2	0.2	1.4
4/1	1254	1254	-	-	-	0.0	0.0	-	0.0	0.0	0.0	0.0	0.0
5/1	3	3	-	-	-	0.0	0.0	-	0.1	65.4	0.0	0.0	0.1
6/1	3	3	-	-	-	0.0	0.0	-	0.0	0.0	0.0	0.0	0.0
Ped Link: P1	0	0	-	-	-	-	-	-	-	-	-	-	-
Ped Link: P2	0	0	-	-	-	-	-	-	-	-	-	-	-
Ped Link: P3	0	0	-	-	-	-	-	-	-	-	-	-	-
Ped Link: P4	0	0	-	-	-	-	-	-	-	-	-	-	-
J2: Woodford Rd South	-	-	0	0	0	3.0	1.0	0.0	4.0	-	-	-	-
1/1	518	518	-	-	-	0.0	0.0	-	0.0	0.0	0.0	0.0	0.0
2/1	518	518	-	-	-	0.0	0.0	-	0.0	0.0	0.0	0.0	0.0
2/2	293	293	-	-	-	1.3	0.4	-	1.8	21.7	3.0	0.4	3.4
3/1	67	67	-	-	-	0.1	0.0	-	0.2	9.7	0.6	0.0	0.6
3/2	550	550	-	-	-	1.5	0.5	-	2.0	13.2	6.0	0.5	6.5
4/1	360	360	-	-	-	0.0	0.0	-	0.0	0.0	0.0	0.0	0.0

Item	Arriving (pcu)	Leaving (pcu)	Turners In Gaps (pcu)	Turners When Unopposed (pcu)	Turners In Intergreen (pcu)	Uniform Delay (pcuHr)	Rand + Oversat Delay (pcuHr)	Storage Area Uniform Delay (pcuHr)	Total Delay (pcuHr)	Av. Delay Per PCU (s/pcu)	Max. Back of Uniform Queue (pcu)	Rand + Oversat Queue (pcu)	Mean Max Queue (pcu)
Ped Link: P1	0	0	-	-	-	-	-	-	-	-	-	-	-
Ped Link: P2	0	0	-	-	-	-	-	-	-	-	-	-	-
			C1	Stream: 1 PRC for Signalled Lanes (%)	11.6	Total Delay for Signalled Lanes (pcuHr):			10.53	Cycle Time (s):		60	
			C1	Stream: 2 PRC for Signalled Lanes (%)	72.0	Total Delay for Signalled Lanes (pcuHr):			3.96	Cycle Time (s):		60	
				PRC Over All Lanes (%)	11.6	Total Delay Over All Lanes (pcuHr):			14.50				

Appendix F.6

A34 Handforth Bypass/ A555 LinSig Output

A34 Handforth Bypass/ A555 LinSig Output

Full Input Data And Results

User and Project Details

Project:	A6MARR
Title:	A34/A6MARR
Location:	
File name:	5 - A6MARR_A34.lsg3x
Author:	PW / GDC
Company:	Atkins
Address:	Bank Chambers, Faulkner Street, Manchester
Notes:	

Network Layout Diagram

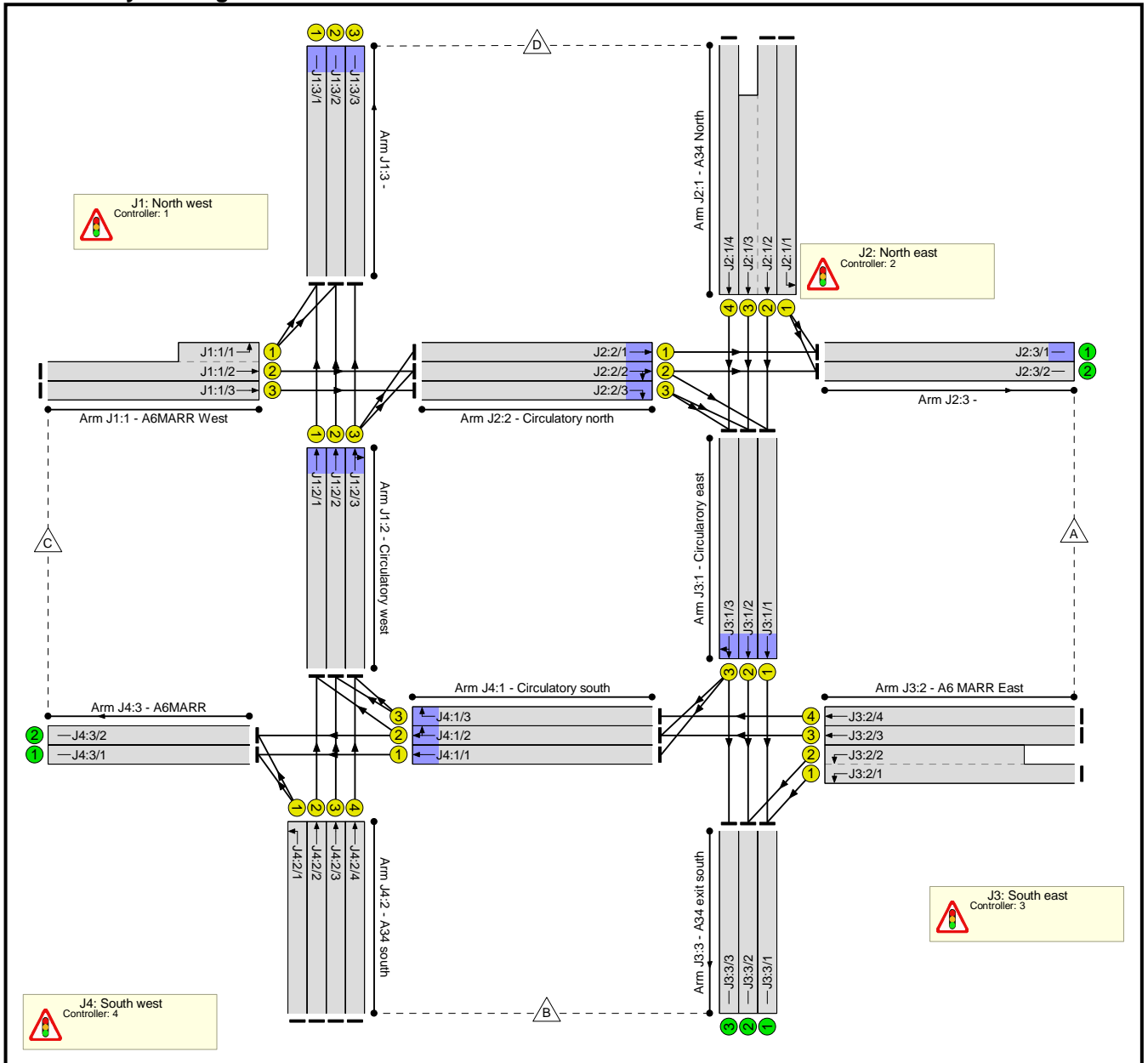

**C1
 Phase Diagram**

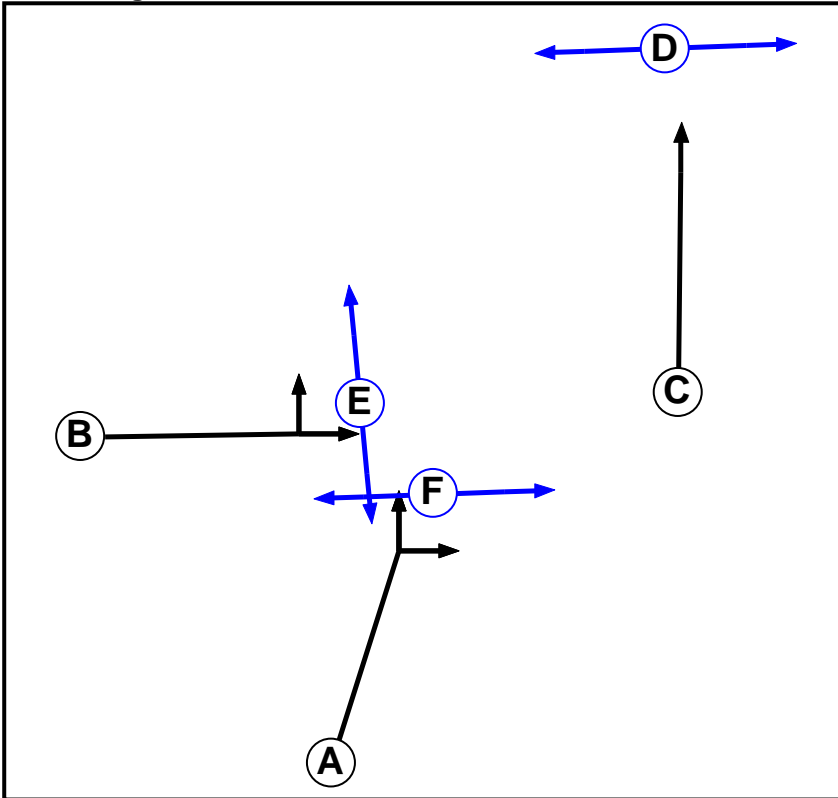

Phase Input Data

Phase Name	Phase Type	Stage Stream	Assoc. Phase	Street Min	Cont Min
A	Traffic	1		7	7
B	Traffic	1		5	5
C	Traffic	2		7	7
D	Pedestrian	2		7	7
E	Pedestrian	1		5	5
F	Pedestrian	1		5	5

Phase Intergreens Matrix

		Starting Phase					
		A	B	C	D	E	F
Terminating Phase	A	5	-	-	-	5	-
	B	5	-	-	5	-	-
	C	-	-	5	-	-	-
	D	-	-	10	-	-	-
	E	-	12	-	-	-	-
	F	12	-	-	-	-	-

Phases in Stage

Stream	Stage No.	Phases in Stage
1	1	A E
1	2	B F
1	3	A
1	4	B
2	1	C
2	2	D

Stage Diagram

Stage Stream: 1

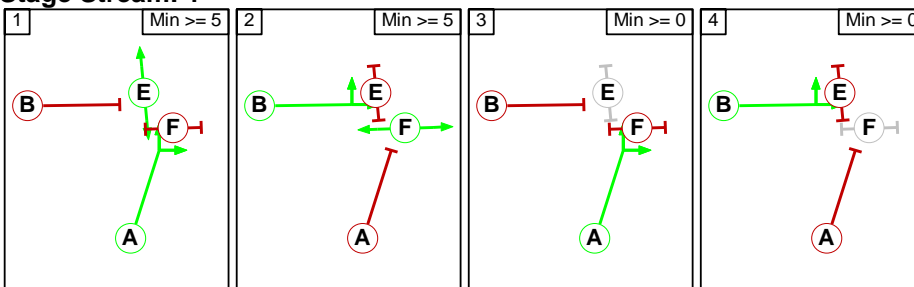

Stage Stream: 2

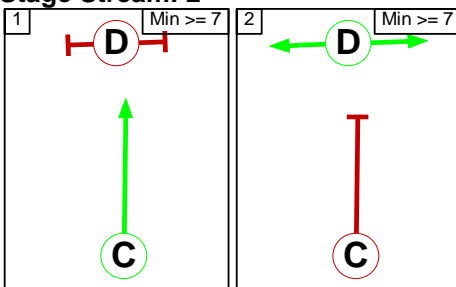

Phase Delays

Stage Stream: 1

Term. Stage	Start Stage	Phase	Type	Value	Cont value
1	2	A	Losing	7	7
1	4	A	Losing	7	7
2	1	B	Losing	7	7
2	3	B	Losing	7	7

Stage Stream: 2

Term. Stage	Start Stage	Phase	Type	Value	Cont value
There are no Phase Delays defined					

**Prohibited Stage Change
 Stage Stream: 1**

		To Stage			
		1	2	3	4
From Stage	1		12	0	12
	2	12		12	0
	3	0	5		5
	4	5	0	5	

Stage Stream: 2

		To Stage	
		1	2
From Stage	1		5
	2	10	

**C2
 Phase Diagram**

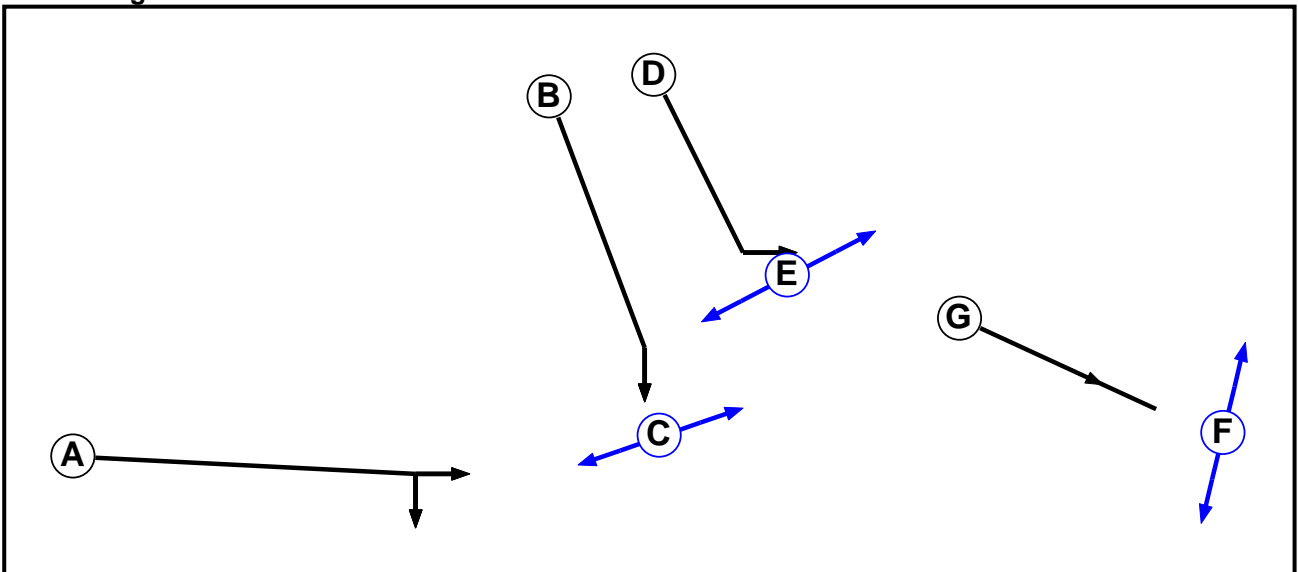

Phase Input Data

Phase Name	Phase Type	Stage Stream	Assoc. Phase	Street Min	Cont Min
A	Traffic	1		7	2
B	Traffic	1		7	7
C	Pedestrian	1		7	7
D	Traffic	1		7	7
E	Pedestrian	1		5	0
F	Pedestrian	2		5	5
G	Traffic	2		7	7

Phase Intergreens Matrix

		Starting Phase						
		A	B	C	D	E	F	G
Terminating Phase	A		5	-	6	-	-	-
	B	5		5	-	-	-	-
	C	-	10		-	-	-	-
	D	5	-	-		5	-	-
	E	-	-	-	5		-	-
	F	-	-	-	-	-		6
	G	-	-	-	-	-	5	

Phases in Stage

Stream	Stage No.	Phases in Stage
1	1	A C E
1	2	B D
2	1	G
2	2	F

Stage Diagram

Stage Stream: 1

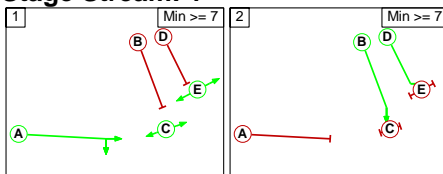

Stage Stream: 2

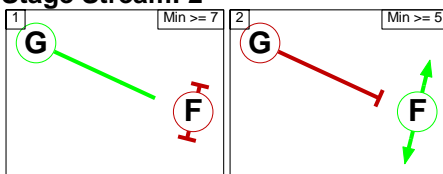

Phase Delays

Stage Stream: 1

Term. Stage	Start Stage	Phase	Type	Value	Cont value
1	2	A	Losing	5	5
1	2	E	Losing	6	6

Stage Stream: 2

Term. Stage	Start Stage	Phase	Type	Value	Cont value
There are no Phase Delays defined					

Prohibited Stage Change
Stage Stream: 1

		To Stage	
		1	2
From Stage	1		11
	2	5	

Stage Stream: 2

		To Stage	
		1	2
From Stage	1		5
	2	6	

C3
Phase Diagram

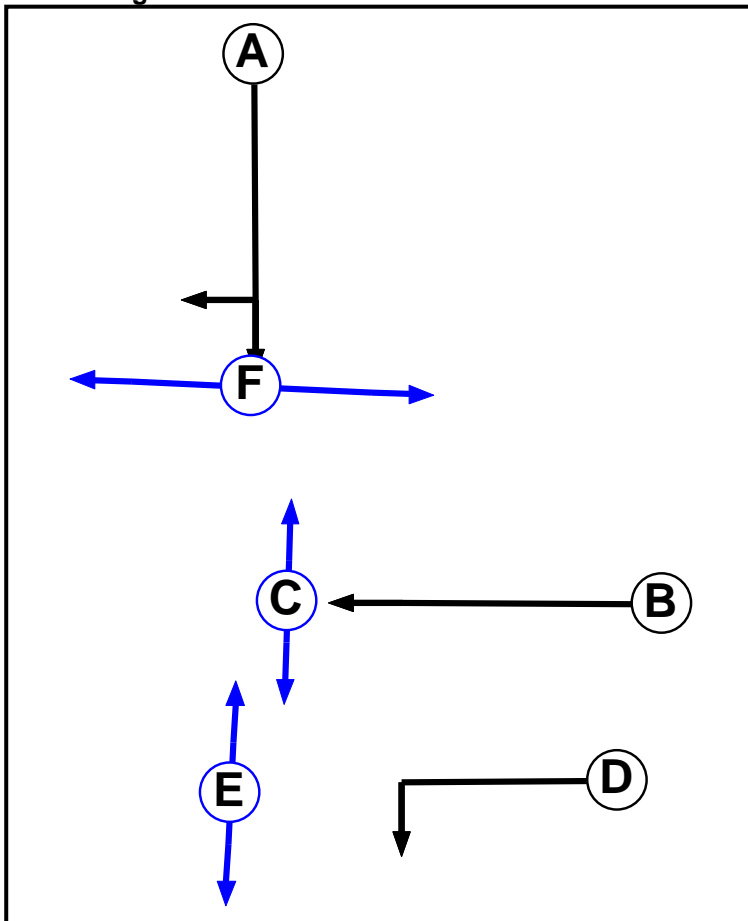

Phase Input Data

Phase Name	Phase Type	Assoc. Phase	Street Min	Cont Min
A	Traffic		7	2
B	Traffic		7	0
C	Pedestrian		7	7
D	Traffic		7	0
E	Pedestrian		5	0
F	Pedestrian		5	5

Phase Intergreens Matrix

		Starting Phase					
		A	B	C	D	E	F
Terminating Phase	A		5	-	7	-	5
	B	5		5	-	-	-
	C	-	10		-	-	-
	D	5	-	-		5	-
	E	-	-	-	5		-
	F	12	-	-	-	-	

Phases in Stage

Stage No.	Phases in Stage
1	A C E
2	B D F

Stage Diagram

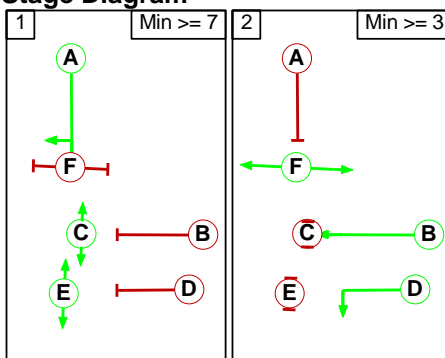

Phase Delays

Term. Stage	Start Stage	Phase	Type	Value	Cont value
1	2	A	Losing	5	5
1	2	E	Losing	6	6
2	1	B	Losing	7	7
2	1	D	Losing	7	7

Prohibited Stage Change

		To Stage	
		1	2
From Stage	1		12
	2	12	

**C4
 Phase Diagram**

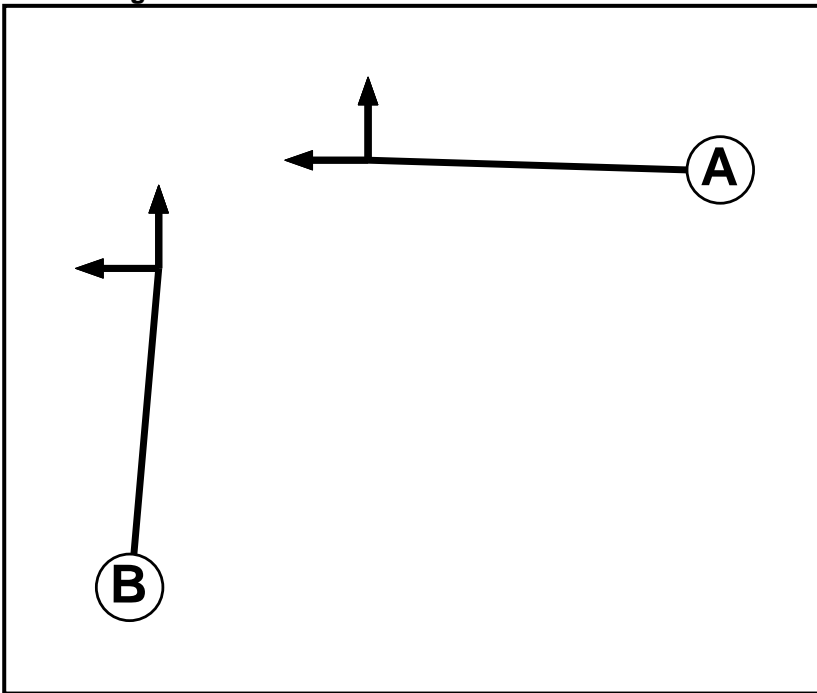

Phase Input Data

Phase Name	Phase Type	Assoc. Phase	Street Min	Cont Min
A	Traffic		7	7
B	Traffic		7	7

Phase Intergreens Matrix

		Starting Phase	
		A	B
Terminating Phase	A		5
	B	5	

Phases in Stage

Stage No.	Phases in Stage
1	A
2	B

Stage Diagram

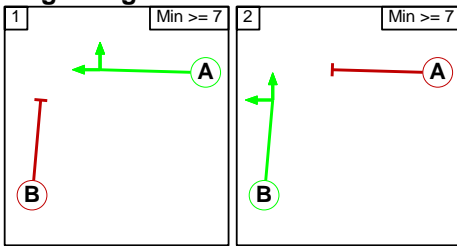

Phase Delays

Term. Stage	Start Stage	Phase	Type	Value	Cont value
There are no Phase Delays defined					

Prohibited Stage Change

		To Stage	
		1	2
From Stage	1		5
	2	5	

Give-Way Lane Input Data

Junction: J1: North west
There are no Opposed Lanes in this Junction

Junction: J2: North east
There are no Opposed Lanes in this Junction

Junction: J3: South east
There are no Opposed Lanes in this Junction

Junction: J4: South west
There are no Opposed Lanes in this Junction

Lane Input Data

Junction: J1: North west												
Lane	Lane Type	Phases	Start Disp.	End Disp.	Physical Length (PCU)	Sat Flow Type	Def User Saturation Flow (PCU/Hr)	Lane Width (m)	Gradient	Nearside Lane	Turns	Turning Radius (m)
J1:1/1 (A6MARR West)	U	B	2	3	6.3	Geom	-	3.75	0.00	N	Arm J1:3 Left	40.00
J1:1/2 (A6MARR West)	U	B	2	3	60.0	Geom	-	3.75	0.00	N	Arm J2:2 Ahead	Inf
J1:1/3 (A6MARR West)	U	B	2	3	21.0	Geom	-	3.75	0.00	N	Arm J2:2 Ahead	Inf
J1:2/1 (Circulatory west)	U	A	2	3	12.5	Geom	-	3.75	0.00	N	Arm J1:3 Ahead	Inf
J1:2/2 (Circulatory west)	U	A	2	3	12.5	Geom	-	3.75	0.00	N	Arm J1:3 Ahead	Inf
J1:2/3 (Circulatory west)	U	A	2	3	12.5	Geom	-	3.75	0.00	N	Arm J2:2 Right Arm J1:3 Ahead	50.00 Inf
J1:3/1	U	C	2	3	60.0	Geom	-	3.75	0.00	N		
J1:3/2	U	C	2	3	60.0	Geom	-	3.75	0.00	N		
J1:3/3	U	C	2	3	60.0	Geom	-	3.50	0.00	N		

Junction: J2: North east												
Lane	Lane Type	Phases	Start Disp.	End Disp.	Physical Length (PCU)	Sat Flow Type	Def User Saturation Flow (PCU/Hr)	Lane Width (m)	Gradient	Nearside Lane	Turns	Turning Radius (m)
J2:1/1 (A34 North)	U	D	2	3	60.0	Geom	-	3.75	0.00	Y	Arm J2:3 Left	40.00
J2:1/2 (A34 North)	U	B	2	3	60.0	Geom	-	3.75	0.00	Y	Arm J3:1 Ahead	Inf
J2:1/3 (A34 North)	U	B	2	3	17.4	Geom	-	3.75	0.00	N	Arm J3:1 Ahead	Inf
J2:1/4 (A34 North)	U	B	2	3	60.0	Geom	-	3.75	0.00	Y	Arm J3:1 Ahead	Inf
J2:2/1 (Circulatory north)	U	A	2	3	5.0	Geom	-	3.75	0.00	N	Arm J2:3 Ahead	100.00
J2:2/2 (Circulatory north)	U	A	2	3	5.0	Geom	-	3.75	0.00	N	Arm J3:1 Right	50.00
											Arm J2:3 Ahead	100.00
J2:2/3 (Circulatory north)	U	A	2	3	3.1	Geom	-	3.75	0.00	N	Arm J3:1 Right	50.00
J2:3/1	U		2	3	60.0	Inf	-	-	-	-	-	-
J2:3/2	U		2	3	60.0	Inf	-	-	-	-	-	-

Junction: J3: South east												
Lane	Lane Type	Phases	Start Disp.	End Disp.	Physical Length (PCU)	Sat Flow Type	Def User Saturation Flow (PCU/Hr)	Lane Width (m)	Gradient	Nearside Lane	Turns	Turning Radius (m)
J3:1/1 (Circularoory east)	U	A	2	3	11.3	Geom	-	3.75	0.00	N	Arm J3:3 Ahead	50.00
J3:1/2 (Circularoory east)	U	A	2	3	11.3	Geom	-	3.75	0.00	N	Arm J3:3 Ahead	50.00
J3:1/3 (Circularoory east)	U	A	2	3	10.8	Geom	-	3.75	0.00	N	Arm J3:3 Ahead	50.00
											Arm J4:1 Right	30.00
J3:2/1 (A6 MARR East)	U	D	2	3	20.9	Geom	-	4.50	0.00	Y	Arm J3:3 Left	30.00
J3:2/2 (A6 MARR East)	U	D	2	3	27.8	Geom	-	3.75	0.00	N	Arm J3:3 Left	30.00
J3:2/3 (A6 MARR East)	U	B	2	3	60.0	Geom	-	3.75	0.00	Y	Arm J4:1 Ahead	Inf
J3:2/4 (A6 MARR East)	U	B	2	3	60.0	Geom	-	3.75	0.00	N	Arm J4:1 Ahead	Inf
J3:3/1 (A34 exit south)	U		2	3	60.0	Inf	-	-	-	-	-	-
J3:3/2 (A34 exit south)	U		2	3	60.0	Inf	-	-	-	-	-	-
J3:3/3 (A34 exit south)	U		2	3	60.0	Inf	-	-	-	-	-	-

Junction: J4: South west												
Lane	Lane Type	Phases	Start Disp.	End Disp.	Physical Length (PCU)	Sat Flow Type	Def User Saturation Flow (PCU/Hr)	Lane Width (m)	Gradient	Nearside Lane	Turns	Turning Radius (m)
J4:1/1 (Circulatory south)	U	A	2	3	60.0	Geom	-	3.75	0.00	N	Arm J4:3 Ahead	100.00
J4:1/2 (Circulatory south)	U	A	2	3	4.3	Geom	-	3.75	0.00	N	Arm J1:2 Right Arm J4:3 Ahead	40.00 100.00
J4:1/3 (Circulatory south)	U	A	2	3	4.3	Geom	-	3.75	0.00	N	Arm J1:2 Right	40.00
J4:2/1 (A34 south)	U	B	2	3	60.0	Geom	-	3.75	0.00	N	Arm J4:3 Left	65.00
J4:2/2 (A34 south)	U	B	2	3	60.0	Geom	-	3.75	0.00	N	Arm J1:2 Ahead	82.50
J4:2/3 (A34 south)	U	B	2	3	60.0	Geom	-	3.75	0.00	N	Arm J1:2 Ahead	82.50
J4:2/4 (A34 south)	U	B	2	3	60.0	Geom	-	3.75	0.00	N	Arm J1:2 Ahead	82.50
J4:3/1 (A6MARR)	U		2	3	60.0	Inf	-	-	-	-	-	-
J4:3/2 (A6MARR)	U		2	3	60.0	Inf	-	-	-	-	-	-

Traffic Flow Groups

Flow Group	Start Time	End Time	Duration	Formula
5: 'Am 2017 with SG'	08:00	09:00	01:00	
6: 'PM 2017 with SG'	17:00	18:00	01:00	

Scenario 5: 'AM 2017 with SG' (FG5: 'Am 2017 with SG', Plan 1: 'Plan1')
Traffic Flows, Desired
Desired Flow :

		Destination				
		A	B	C	D	Tot.
Origin	A	0	498	0	742	1240
	B	277	0	309	1985	2571
	C	0	153	0	212	365
	D	800	2085	318	0	3203
	Tot.	1077	2736	627	2939	7379

Traffic Lane Flows

Lane	Scenario 5: AM 2017 with SG
Junction: J1: North west	
J1:1/1 (short)	212
J1:1/2 (with short)	224(In) 12(Out)
J1:1/3	141
J1:2/1	1093
J1:2/2	911
J1:2/3	1000
J1:3/1	1170
J1:3/2	1046
J1:3/3	723
Junction: J2: North east	
J2:1/1	800
J2:1/2 (with short)	1599(In) 836(Out)
J2:1/3 (short)	763
J2:1/4	804
J2:2/1	146
J2:2/2	143
J2:2/3	141
J2:3/1	546
J2:3/2	531
Junction: J3: South east	
J3:1/1	848
J3:1/2	846
J3:1/3	862
J3:2/1 (with short)	498(In) 245(Out)
J3:2/2 (short)	253
J3:2/3	340
J3:2/4	402
J3:3/1	1093
J3:3/2	1099
J3:3/3	544

Junction: J4: South west	
J4:1/1	180
J4:1/2	478
J4:1/3	402
J4:2/1	309
J4:2/2	753
J4:2/3	755
J4:2/4	754
J4:3/1	334
J4:3/2	293

Lane Saturation Flows

Junction: J1: North west								
Lane	Lane Width (m)	Gradient	Nearside Lane	Allowed Turns	Turning Radius (m)	Turning Prop.	Sat Flow (PCU/Hr)	Flared Sat Flow (PCU/Hr)
J1:1/1 (A6MARR West)	3.75	0.00	N	Arm J1:3 Left	40.00	100.0 %	2053	2053
J1:1/2 (A6MARR West)	3.75	0.00	N	Arm J2:2 Ahead	Inf	100.0 %	2130	2130
J1:1/3 (A6MARR West)	3.75	0.00	N	Arm J2:2 Ahead	Inf	100.0 %	2130	2130
J1:2/1 (Circulatory west)	3.75	0.00	N	Arm J1:3 Ahead	Inf	100.0 %	2130	2130
J1:2/2 (Circulatory west)	3.75	0.00	N	Arm J1:3 Ahead	Inf	100.0 %	2130	2130
J1:2/3 (Circulatory west)	3.75	0.00	N	Arm J2:2 Right	50.00	27.7 %	2112	2112
				Arm J1:3 Ahead	Inf	72.3 %		
J1:3/1	3.75	0.00	N				2130	2130
J1:3/2	3.75	0.00	N				2130	2130
J1:3/3	3.50	0.00	N				2105	2105

Junction: J2: North east								
Lane	Lane Width (m)	Gradient	Nearside Lane	Allowed Turns	Turning Radius (m)	Turning Prop.	Sat Flow (PCU/Hr)	Flared Sat Flow (PCU/Hr)
J2:1/1 (A34 North)	3.75	0.00	Y	Arm J2:3 Left	40.00	100.0 %	1918	1918
J2:1/2 (A34 North)	3.75	0.00	Y	Arm J3:1 Ahead	Inf	100.0 %	1990	1990
J2:1/3 (A34 North)	3.75	0.00	N	Arm J3:1 Ahead	Inf	100.0 %	2130	2130
J2:1/4 (A34 North)	3.75	0.00	Y	Arm J3:1 Ahead	Inf	100.0 %	1990	1990
J2:2/1 (Circulatory north)	3.75	0.00	N	Arm J2:3 Ahead	100.00	100.0 %	2099	2099
J2:2/2 (Circulatory north)	3.75	0.00	N	Arm J3:1 Right	50.00	8.4 %	2096	2096
J2:2/3 (Circulatory north)	3.75	0.00	N	Arm J2:3 Ahead	100.00	91.6 %	2068	2068
J2:3/1				Infinite Saturation Flow			Inf	Inf
J2:3/2				Infinite Saturation Flow			Inf	Inf

Junction: J3: South east								
Lane	Lane Width (m)	Gradient	Nearside Lane	Allowed Turns	Turning Radius (m)	Turning Prop.	Sat Flow (PCU/Hr)	Flared Sat Flow (PCU/Hr)
J3:1/1 (Circularory east)	3.75	0.00	N	Arm J3:3 Ahead	50.00	100.0 %	2068	2068
J3:1/2 (Circularory east)	3.75	0.00	N	Arm J3:3 Ahead	50.00	100.0 %	2068	2068
J3:1/3 (Circularory east)	3.75	0.00	N	Arm J3:3 Ahead	50.00	63.1 %	2053	2053
J3:1/3 (Circularory east)	3.75	0.00	N	Arm J4:1 Right	30.00	36.9 %		
J3:2/1 (A6 MARR East)	4.50	0.00	Y	Arm J3:3 Left	30.00	100.0 %	1967	1967
J3:2/2 (A6 MARR East)	3.75	0.00	N	Arm J3:3 Left	30.00	100.0 %	2029	2029
J3:2/3 (A6 MARR East)	3.75	0.00	Y	Arm J4:1 Ahead	Inf	100.0 %	1990	1990
J3:2/4 (A6 MARR East)	3.75	0.00	N	Arm J4:1 Ahead	Inf	100.0 %	2130	2130
J3:3/1 (A34 exit south Lane 1)				Infinite Saturation Flow			Inf	Inf
J3:3/2 (A34 exit south Lane 2)				Infinite Saturation Flow			Inf	Inf
J3:3/3 (A34 exit south Lane 3)				Infinite Saturation Flow			Inf	Inf

Junction: J4: South west								
Lane	Lane Width (m)	Gradient	Nearside Lane	Allowed Turns	Turning Radius (m)	Turning Prop.	Sat Flow (PCU/Hr)	Flared Sat Flow (PCU/Hr)
J4:1/1 (Circulatory south)	3.75	0.00	N	Arm J4:3 Ahead	100.00	100.0 %	2099	2099
J4:1/2 (Circulatory south)	3.75	0.00	N	Arm J1:2 Right Arm J4:3 Ahead	40.00 100.00	71.1 % 28.9 %	2066	2066
J4:1/3 (Circulatory south)	3.75	0.00	N	Arm J1:2 Right	40.00	100.0 %	2053	2053
J4:2/1 (A34 south)	3.75	0.00	N	Arm J4:3 Left	65.00	100.0 %	2082	2082
J4:2/2 (A34 south)	3.75	0.00	N	Arm J1:2 Ahead	82.50	100.0 %	2092	2092
J4:2/3 (A34 south)	3.75	0.00	N	Arm J1:2 Ahead	82.50	100.0 %	2092	2092
J4:2/4 (A34 south)	3.75	0.00	N	Arm J1:2 Ahead	82.50	100.0 %	2092	2092
J4:3/1 (A6MARR Lane 1)				Infinite Saturation Flow			Inf	Inf
J4:3/2 (A6MARR Lane 2)				Infinite Saturation Flow			Inf	Inf

Scenario 6: 'PM 2017 with SG' (FG6: 'PM 2017 with SG', Plan 1: 'Plan1')

Traffic Flows, Desired

Desired Flow :

		Destination				
		A	B	C	D	Tot.
Origin	A	0	323	0	724	1047
	B	493	0	291	1968	2752
	C	0	251	0	197	448
	D	881	1985	194	0	3060
	Tot.	1374	2559	485	2889	7307

Traffic Lane Flows

Lane	Scenario 6: PM 2017 with SG
Junction: J1: North west	
J1:1/1 (short)	197
J1:1/2 (with short)	322(In) 125(Out)
J1:1/3	126
J1:2/1	1182
J1:2/2	1002
J1:2/3	1001
J1:3/1	1379
J1:3/2	1002
J1:3/3	508
Junction: J2: North east	
J2:1/1	881
J2:1/2 (with short)	1449(In) 725(Out)
J2:1/3 (short)	724
J2:1/4	730
J2:2/1	247
J2:2/2	371
J2:2/3	126
J2:3/1	687
J2:3/2	687
Junction: J3: South east	
J3:1/1	850
J3:1/2	787
J3:1/3	793
J3:2/1 (with short)	323(In) 161(Out)
J3:2/2 (short)	162
J3:2/3	362
J3:2/4	362
J3:3/1	1011
J3:3/2	949
J3:3/3	599

Junction: J4: South west	
J4:1/1	104
J4:1/2	452
J4:1/3	362
J4:2/1	291
J4:2/2	820
J4:2/3	821
J4:2/4	820
J4:3/1	249
J4:3/2	236

Lane Saturation Flows

Junction: J1: North west								
Lane	Lane Width (m)	Gradient	Nearside Lane	Allowed Turns	Turning Radius (m)	Turning Prop.	Sat Flow (PCU/Hr)	Flared Sat Flow (PCU/Hr)
J1:1/1 (A6MARR West)	3.75	0.00	N	Arm J1:3 Left	40.00	100.0 %	2053	2053
J1:1/2 (A6MARR West)	3.75	0.00	N	Arm J2:2 Ahead	Inf	100.0 %	2130	2130
J1:1/3 (A6MARR West)	3.75	0.00	N	Arm J2:2 Ahead	Inf	100.0 %	2130	2130
J1:2/1 (Circulatory west)	3.75	0.00	N	Arm J1:3 Ahead	Inf	100.0 %	2130	2130
J1:2/2 (Circulatory west)	3.75	0.00	N	Arm J1:3 Ahead	Inf	100.0 %	2130	2130
J1:2/3 (Circulatory west)	3.75	0.00	N	Arm J2:2 Right Arm J1:3 Ahead	50.00 Inf	49.3 % 50.7 %	2099	2099
J1:3/1	3.75	0.00	N				2130	2130
J1:3/2	3.75	0.00	N				2130	2130
J1:3/3	3.50	0.00	N				2105	2105

Junction: J2: North east								
Lane	Lane Width (m)	Gradient	Nearside Lane	Allowed Turns	Turning Radius (m)	Turning Prop.	Sat Flow (PCU/Hr)	Flared Sat Flow (PCU/Hr)
J2:1/1 (A34 North)	3.75	0.00	Y	Arm J2:3 Left	40.00	100.0 %	1918	1918
J2:1/2 (A34 North)	3.75	0.00	Y	Arm J3:1 Ahead	Inf	100.0 %	1990	1990
J2:1/3 (A34 North)	3.75	0.00	N	Arm J3:1 Ahead	Inf	100.0 %	2130	2130
J2:1/4 (A34 North)	3.75	0.00	Y	Arm J3:1 Ahead	Inf	100.0 %	1990	1990
J2:2/1 (Circulatory north)	3.75	0.00	N	Arm J2:3 Ahead	100.00	100.0 %	2099	2099
J2:2/2 (Circulatory north)	3.75	0.00	N	Arm J3:1 Right	50.00	33.7 %	2088	2088
J2:2/3 (Circulatory north)	3.75	0.00	N	Arm J2:3 Ahead	100.00	66.3 %	2068	2068
J2:3/1				Arm J3:1 Right	50.00	100.0 %	2068	2068
J2:3/2				Infinite Saturation Flow			Inf	Inf
				Infinite Saturation Flow			Inf	Inf

Junction: J3: South east								
Lane	Lane Width (m)	Gradient	Nearside Lane	Allowed Turns	Turning Radius (m)	Turning Prop.	Sat Flow (PCU/Hr)	Flared Sat Flow (PCU/Hr)
J3:1/1 (Circularory east)	3.75	0.00	N	Arm J3:3 Ahead	50.00	100.0 %	2068	2068
J3:1/2 (Circularory east)	3.75	0.00	N	Arm J3:3 Ahead	50.00	100.0 %	2068	2068
J3:1/3 (Circularory east)	3.75	0.00	N	Arm J3:3 Ahead	50.00	75.5 %	2058	2058
J3:2/1 (A6 MARR East)	4.50	0.00	Y	Arm J4:1 Right	30.00	24.5 %	1967	1967
J3:2/2 (A6 MARR East)	3.75	0.00	N	Arm J3:3 Left	30.00	100.0 %	2029	2029
J3:2/3 (A6 MARR East)	3.75	0.00	Y	Arm J3:3 Left	30.00	100.0 %	1990	1990
J3:2/4 (A6 MARR East)	3.75	0.00	N	Arm J4:1 Ahead	Inf	100.0 %	2130	2130
J3:3/1 (A34 exit south Lane 1)				Arm J4:1 Ahead	Inf	100.0 %	2130	2130
J3:3/2 (A34 exit south Lane 2)				Infinite Saturation Flow			Inf	Inf
J3:3/3 (A34 exit south Lane 3)				Infinite Saturation Flow			Inf	Inf

Junction: J4: South west								
Lane	Lane Width (m)	Gradient	Nearside Lane	Allowed Turns	Turning Radius (m)	Turning Prop.	Sat Flow (PCU/Hr)	Flared Sat Flow (PCU/Hr)
J4:1/1 (Circulatory south)	3.75	0.00	N	Arm J4:3 Ahead	100.00	100.0 %	2099	2099
J4:1/2 (Circulatory south)	3.75	0.00	N	Arm J1:2 Right Arm J4:3 Ahead	40.00 100.00	80.1 % 19.9 %	2062	2062
J4:1/3 (Circulatory south)	3.75	0.00	N	Arm J1:2 Right	40.00	100.0 %	2053	2053
J4:2/1 (A34 south)	3.75	0.00	N	Arm J4:3 Left	65.00	100.0 %	2082	2082
J4:2/2 (A34 south)	3.75	0.00	N	Arm J1:2 Ahead	82.50	100.0 %	2092	2092
J4:2/3 (A34 south)	3.75	0.00	N	Arm J1:2 Ahead	82.50	100.0 %	2092	2092
J4:2/4 (A34 south)	3.75	0.00	N	Arm J1:2 Ahead	82.50	100.0 %	2092	2092
J4:3/1 (A6MARR Lane 1)				Infinite Saturation Flow			Inf	Inf
J4:3/2 (A6MARR Lane 2)				Infinite Saturation Flow			Inf	Inf

Scenario 5: 'AM 2017 with SG' (FG5: 'Am 2017 with SG', Plan 1: 'Plan1')

C1

Stage Sequence Diagram

Stage Stream: 1

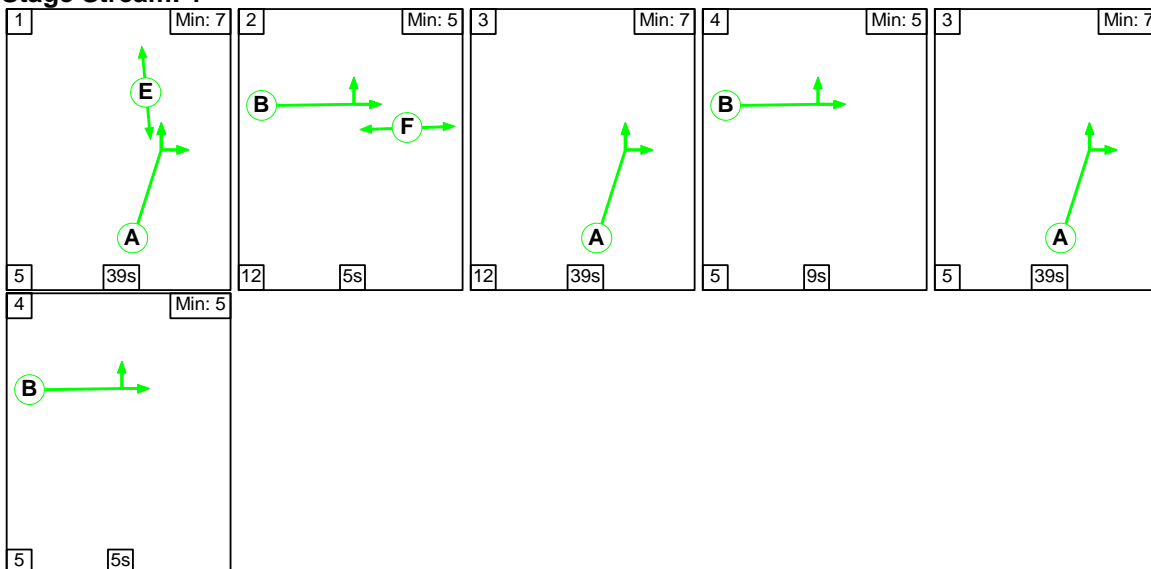

Stage Stream: 2

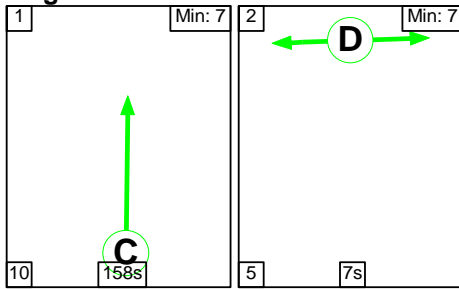

Stage Timings

Stage Stream: 1

Stage	1	2	3	4	3	4
Duration	39	5	39	9	39	5
Change Point	0	44	61	112	126	170

Stage Stream: 2

Stage	1	2
Duration	158	7
Change Point	66	54

Signal Timings Diagram

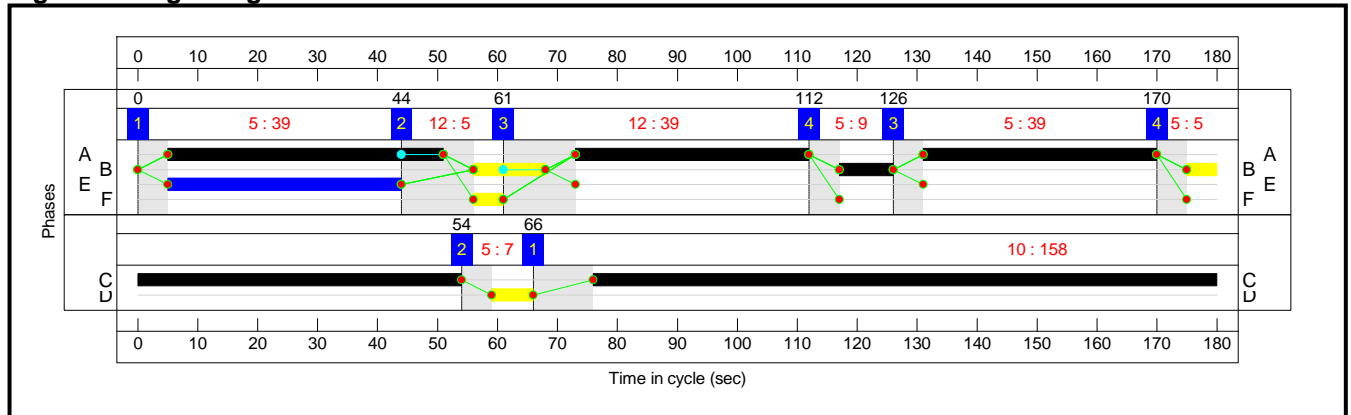

C2

Stage Sequence Diagram

Stage Stream: 1

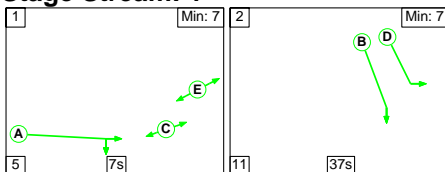

Stage Stream: 2

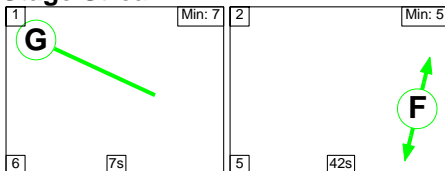

Stage Timings

Stage Stream: 1

Stage	1	2	1	2	1	2
Duration	7	37	7	37	7	37
Change Point	108	120	168	0	48	60

Stage Stream: 2

Stage	1	2	1	2	1	2
Duration	7	42	7	42	7	42
Change Point	0	13	60	73	120	133

Signal Timings Diagram

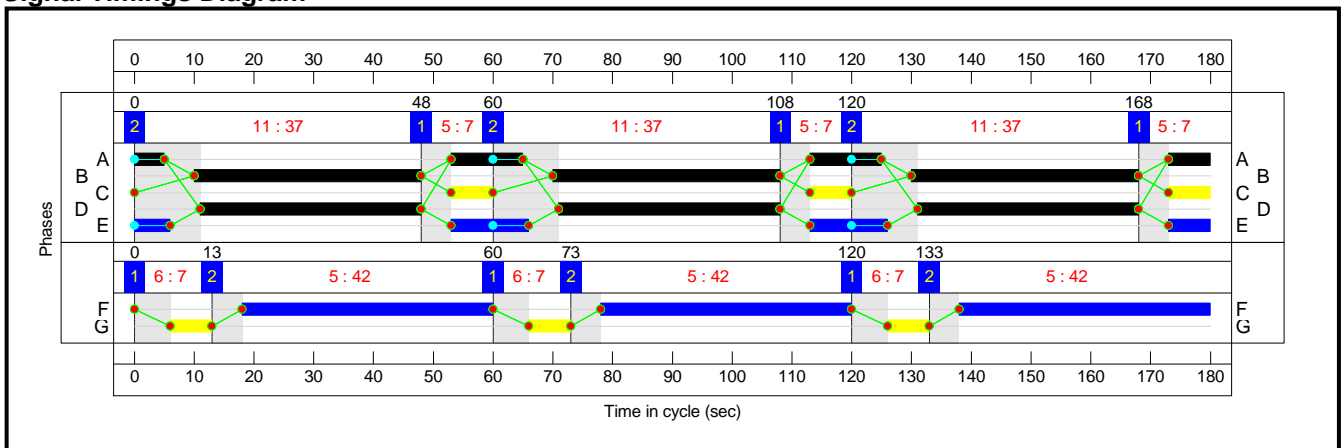

C3

Stage Sequence Diagram

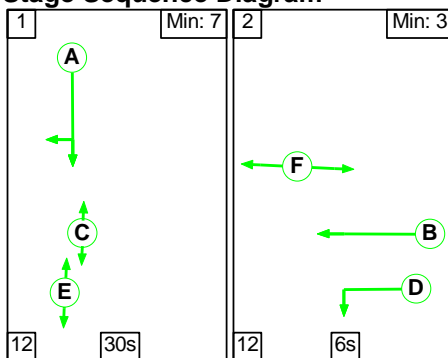

Stage Timings

Stage	1	2	1	2	1	2
Duration	30	6	30	6	30	6
Change Point	0	42	60	102	120	162

Signal Timings Diagram

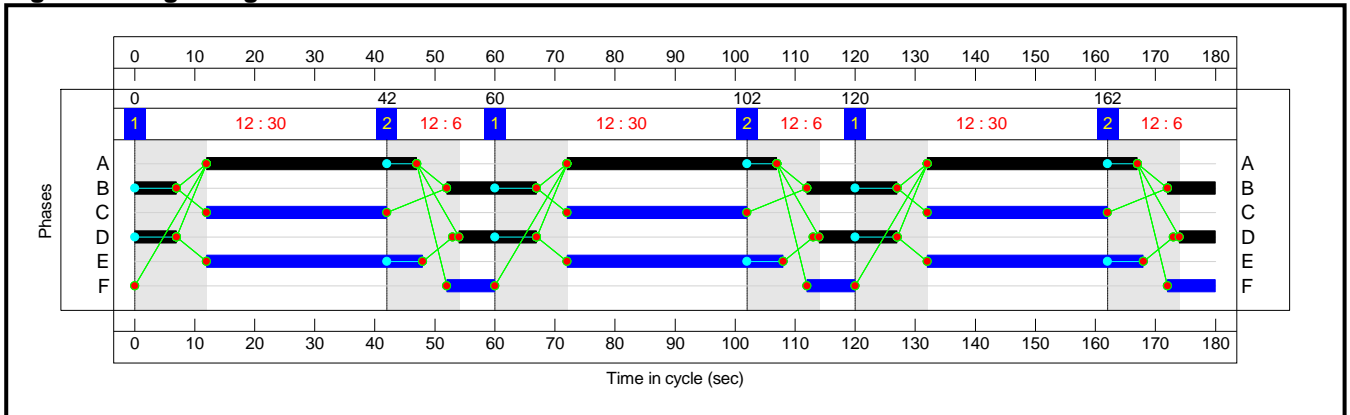

C4 Stage Sequence Diagram

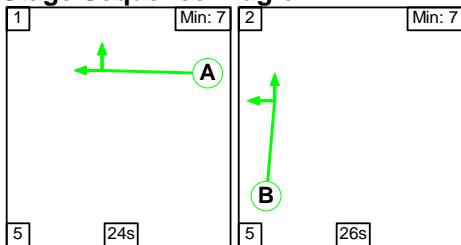

Stage Timings

Stage	1	2	1	2	1	2
Duration	24	26	24	26	24	26
Change Point	108	137	168	17	48	77

Signal Timings Diagram

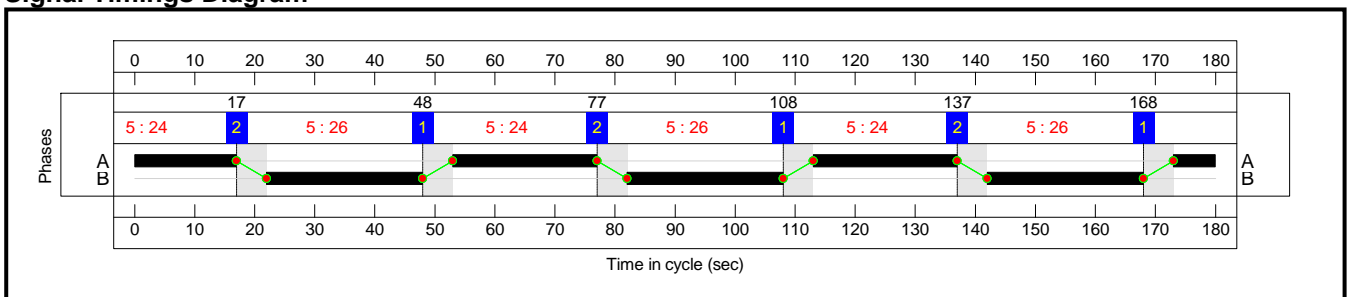

Network Layout Diagram

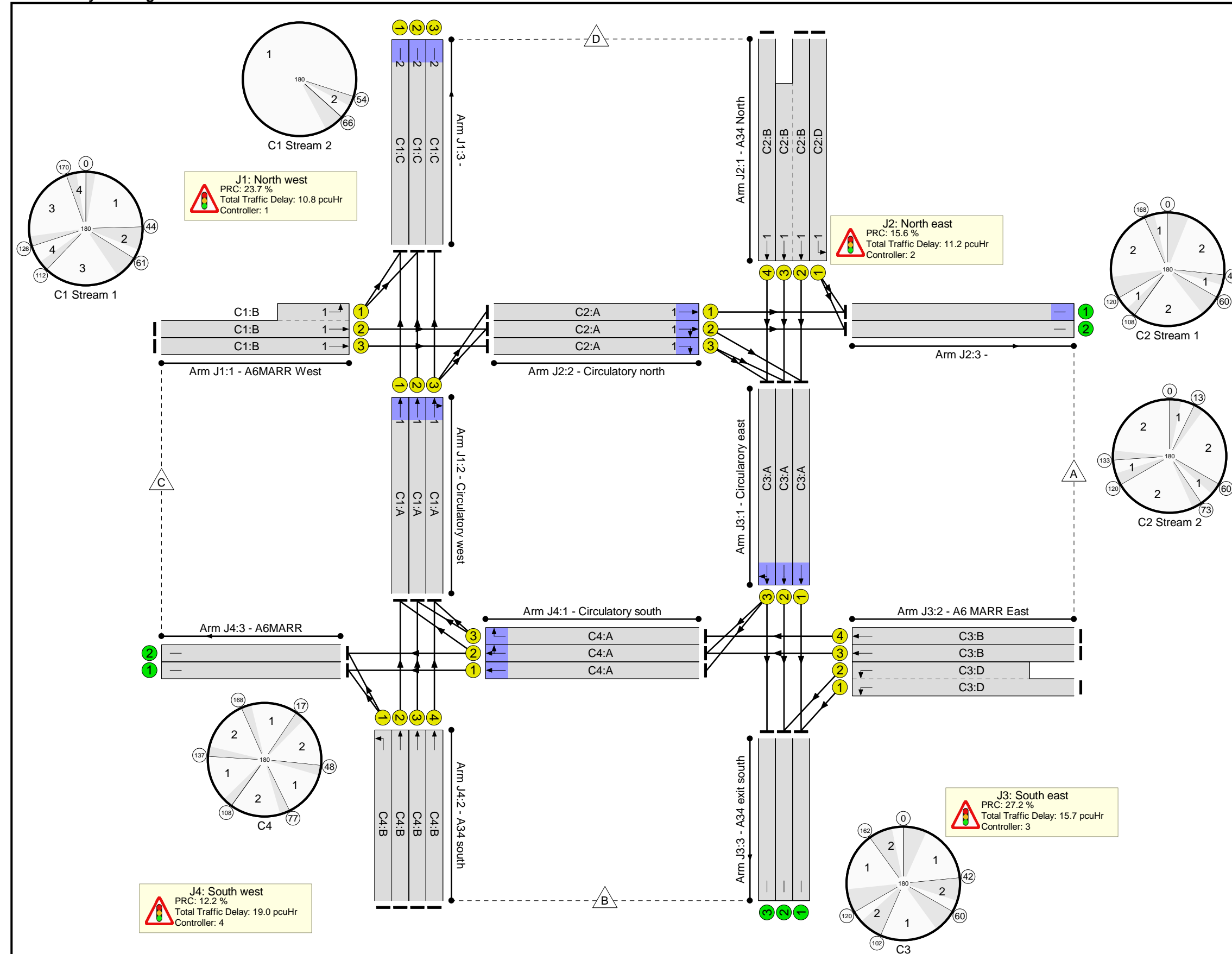

Network Results

Item	Lane Description	Lane Type	Controller Stream	Position In Filtered Route	Full Phase	Arrow Phase	Num Greens	Total Green (s)	Arrow Green (s)	Demand Flow (pcu)	Sat Flow (pcu/Hr)	Capacity (pcu)	Deg Sat (%)
Network: A34/A6MARR	-	-	N/A	-	-		-	-	-	-	-	-	80.2%
J1: North west	-	-	N/A	-	-		-	-	-	-	-	-	72.7%
1/2+1/1	A6MARR West Ahead Left	U	1:1	N/A	C1:B		3	26	-	224	2130:2053	19+327	64.8 : 64.8%
1/3	A6MARR West Ahead	U	1:1	N/A	C1:B		3	26	-	141	2130	343	41.1%
2/1	Circulatory west Ahead	U	1:1	N/A	C1:A		3	124	-	1093	2130	1503	72.7%
2/2	Circulatory west Ahead	U	1:1	N/A	C1:A		3	124	-	911	2130	1503	60.6%
2/3	Circulatory west Right Ahead	U	1:1	N/A	C1:A		3	124	-	1000	2112	1490	67.1%
3/1		U	1:2	N/A	C1:C		1	158	-	1170	2130	1882	62.2%
3/2		U	1:2	N/A	C1:C		1	158	-	1046	2130	1882	55.6%
3/3		U	1:2	N/A	C1:C		1	158	-	723	2105	1859	38.9%
J2: North east	-	-	N/A	-	-		-	-	-	-	-	-	77.8%
1/1	A34 North Left	U	2:1	N/A	C2:D		3	111	-	800	1918	1215	65.9%
1/2+1/3	A34 North Ahead	U	2:1	N/A	C2:B		3	114	-	1599	1990:2130	1074+980	77.8 : 77.8%
1/4	A34 North Ahead	U	2:1	N/A	C2:B		3	114	-	804	1990	1294	62.2%
2/1	Circulatory north Ahead	U	2:1	N/A	C2:A		3	36	-	146	2099	455	32.1%
2/2	Circulatory north Right Ahead	U	2:1	N/A	C2:A		3	36	-	143	2096	454	31.5%
2/3	Circulatory north Right	U	2:1	N/A	C2:A		3	36	-	141	2068	448	31.5%

Item	Lane Description	Lane Type	Controller Stream	Position In Filtered Route	Full Phase	Arrow Phase	Num Greens	Total Green (s)	Arrow Green (s)	Demand Flow (pcu)	Sat Flow (pcu/Hr)	Capacity (pcu)	Deg Sat (%)
3/1		U	N/A	N/A	-		-	-	-	546	Inf	Inf	0.0%
3/2		U	N/A	N/A	-		-	-	-	531	Inf	Inf	0.0%
J3: South east	-	-	N/A	-	-		-	-	-	-	-	-	70.8%
1/1	Circularory east Ahead	U	N/A	N/A	C3:A		3	105	-	848	2068	1241	68.3%
1/2	Circularory east Ahead	U	N/A	N/A	C3:A		3	105	-	846	2068	1241	68.2%
1/3	Circularory east Ahead Right	U	N/A	N/A	C3:A		3	105	-	862	2053	1232	70.0%
2/1+2/2	A6 MARR East Left	U	N/A	N/A	C3:D		3	39	-	498	1967:2029	459+473	53.4 : 53.4%
2/3	A6 MARR East Ahead	U	N/A	N/A	C3:B		3	45	-	340	1990	531	64.1%
2/4	A6 MARR East Ahead	U	N/A	N/A	C3:B		3	45	-	402	2130	568	70.8%
3/1	A34 exit south	U	N/A	N/A	-		-	-	-	1093	Inf	Inf	0.0%
3/2	A34 exit south	U	N/A	N/A	-		-	-	-	1099	Inf	Inf	0.0%
3/3	A34 exit south	U	N/A	N/A	-		-	-	-	544	Inf	Inf	0.0%
J4: South west	-	-	N/A	-	-		-	-	-	-	-	-	80.2%
1/1	Circulatory south Ahead	U	N/A	N/A	C4:A		3	72	-	180	2099	875	20.6%
1/2	Circulatory south Right Ahead	U	N/A	N/A	C4:A		3	72	-	478	2066	861	55.5%
1/3	Circulatory south Right	U	N/A	N/A	C4:A		3	72	-	402	2053	855	47.0%
2/1	A34 south Left	U	N/A	N/A	C4:B		3	78	-	309	2082	937	33.0%
2/2	A34 south Ahead	U	N/A	N/A	C4:B		3	78	-	753	2092	941	80.0%
2/3	A34 south Ahead	U	N/A	N/A	C4:B		3	78	-	755	2092	941	80.2%

Item	Lane Description	Lane Type	Controller Stream	Position In Filtered Route	Full Phase	Arrow Phase	Num Greens	Total Green (s)	Arrow Green (s)	Demand Flow (pcu)	Sat Flow (pcu/Hr)	Capacity (pcu)	Deg Sat (%)
2/4	A34 south Ahead	U	N/A	N/A	C4:B		3	78	-	754	2092	941	80.1%
3/1	A6MARR	U	N/A	N/A	-		-	-	-	334	Inf	Inf	0.0%
3/2	A6MARR	U	N/A	N/A	-		-	-	-	293	Inf	Inf	0.0%

Item	Arriving (pcu)	Leaving (pcu)	Turners In Gaps (pcu)	Turners When Unopposed (pcu)	Turners In Intergreen (pcu)	Uniform Delay (pcuHr)	Rand + Oversat Delay (pcuHr)	Storage Area Uniform Delay (pcuHr)	Total Delay (pcuHr)	Av. Delay Per PCU (s/pcu)	Max. Back of Uniform Queue (pcu)	Rand + Oversat Queue (pcu)	Mean Max Queue (pcu)
Network: A34/A6MARR	-	-	0	0	0	33.1	23.6	0.0	56.7	-	-	-	-
J1: North west	-	-	0	0	0	4.6	6.1	0.0	10.8	-	-	-	-
1/2+1/1	224	224	-	-	-	1.5	0.9	-	2.4	38.1	3.6	0.9	4.5
1/3	141	141	-	-	-	0.9	0.3	-	1.2	31.6	2.3	0.3	2.6
2/1	1093	1093	-	-	-	0.7	1.3	-	2.0	6.6	6.9	1.3	8.3
2/2	911	911	-	-	-	0.5	0.8	-	1.2	4.9	3.6	0.8	4.3
2/3	1000	1000	-	-	-	0.5	1.0	-	1.6	5.6	5.1	1.0	6.1
3/1	1170	1170	-	-	-	0.2	0.8	-	1.1	3.2	8.7	0.8	9.6
3/2	1046	1046	-	-	-	0.3	0.6	-	1.0	3.3	6.8	0.6	7.5
3/3	723	723	-	-	-	0.0	0.3	-	0.3	1.7	0.2	0.3	0.5
J2: North east	-	-	0	0	0	7.0	4.2	0.0	11.2	-	-	-	-
1/1	800	800	-	-	-	1.5	1.0	-	2.5	11.2	8.2	1.0	9.2
1/2+1/3	1599	1599	-	-	-	2.7	1.7	-	4.4	10.0	8.4	1.7	10.1
1/4	804	804	-	-	-	1.4	0.8	-	2.2	9.8	7.8	0.8	8.6
2/1	146	146	-	-	-	0.5	0.2	-	0.7	17.3	2.4	0.2	2.6
2/2	143	143	-	-	-	0.4	0.2	-	0.7	16.9	2.1	0.2	2.3
2/3	141	141	-	-	-	0.5	0.2	-	0.7	18.9	0.9	0.2	1.1
3/1	546	546	-	-	-	0.0	0.0	-	0.0	0.0	0.0	0.0	0.0
3/2	531	531	-	-	-	0.0	0.0	-	0.0	0.0	0.0	0.0	0.0
J3: South east	-	-	0	0	0	9.7	5.9	0.0	15.7	-	-	-	-
1/1	848	848	-	-	-	0.9	1.1	-	2.0	8.5	2.9	1.1	4.0
1/2	846	846	-	-	-	1.0	1.1	-	2.0	8.7	4.2	1.1	5.2

Item	Arriving (pcu)	Leaving (pcu)	Turners In Gaps (pcu)	Turners When Unopposed (pcu)	Turners In Intergreen (pcu)	Uniform Delay (pcuHr)	Rand + Oversat Delay (pcuHr)	Storage Area Uniform Delay (pcuHr)	Total Delay (pcuHr)	Av. Delay Per PCU (s/pcu)	Max. Back of Uniform Queue (pcu)	Rand + Oversat Queue (pcu)	Mean Max Queue (pcu)
1/3	862	862	-	-	-	1.0	1.2	-	2.1	8.9	3.7	1.2	4.8
2/1+2/2	498	498	-	-	-	2.8	0.6	-	3.4	24.3	3.7	0.6	4.2
2/3	340	340	-	-	-	1.8	0.9	-	2.7	28.8	5.0	0.9	5.9
2/4	402	402	-	-	-	2.2	1.2	-	3.4	30.6	6.0	1.2	7.2
3/1	1093	1093	-	-	-	0.0	0.0	-	0.0	0.0	0.0	0.0	0.0
3/2	1099	1099	-	-	-	0.0	0.0	-	0.0	0.0	0.0	0.0	0.0
3/3	544	544	-	-	-	0.0	0.0	-	0.0	0.0	0.0	0.0	0.0
J4: South west	-	-	0	0	0	11.7	7.4	0.0	19.0	-	-	-	-
1/1	180	180	-	-	-	1.0	0.1	-	1.1	22.8	2.9	0.1	3.0
1/2	478	478	-	-	-	0.8	0.6	-	1.4	10.6	2.2	0.6	2.9
1/3	402	402	-	-	-	0.0	0.4	-	0.5	4.3	0.1	0.4	0.5
2/1	309	309	-	-	-	0.9	0.2	-	1.2	13.5	3.3	0.2	3.5
2/2	753	753	-	-	-	3.0	2.0	-	4.9	23.5	10.7	2.0	12.6
2/3	755	755	-	-	-	3.0	2.0	-	5.0	23.7	10.7	2.0	12.7
2/4	754	754	-	-	-	3.0	2.0	-	4.9	23.6	10.7	2.0	12.7
3/1	334	334	-	-	-	0.0	0.0	-	0.0	0.0	0.0	0.0	0.0
3/2	293	293	-	-	-	0.0	0.0	-	0.0	0.0	0.0	0.0	0.0
			C1	Stream: 1 PRC for Signalled Lanes (%)	23.7	Total Delay for Signalled Lanes (pcuHr):			8.42	Cycle Time (s): 180			
			C1	Stream: 2 PRC for Signalled Lanes (%)	44.7	Total Delay for Signalled Lanes (pcuHr):			2.35	Cycle Time (s): 180			
			C2	Stream: 1 PRC for Signalled Lanes (%)	15.6	Total Delay for Signalled Lanes (pcuHr):			11.24	Cycle Time (s): 180			
			C2	Stream: 2 PRC for Signalled Lanes (%)	0.0	Total Delay for Signalled Lanes (pcuHr):			0.00	Cycle Time (s): 180			
			C3	PRC for Signalled Lanes (%)	27.2	Total Delay for Signalled Lanes (pcuHr):			15.69	Cycle Time (s): 180			
			C4	PRC for Signalled Lanes (%)	12.2	Total Delay for Signalled Lanes (pcuHr):			19.02	Cycle Time (s): 180			
				PRC Over All Lanes (%)	12.2	Total Delay Over All Lanes (pcuHr):			56.72				

Scenario 6: 'PM 2017 with SG' (FG6: 'PM 2017 with SG', Plan 1: 'Plan1')

C1

Stage Sequence Diagram

Stage Stream: 1

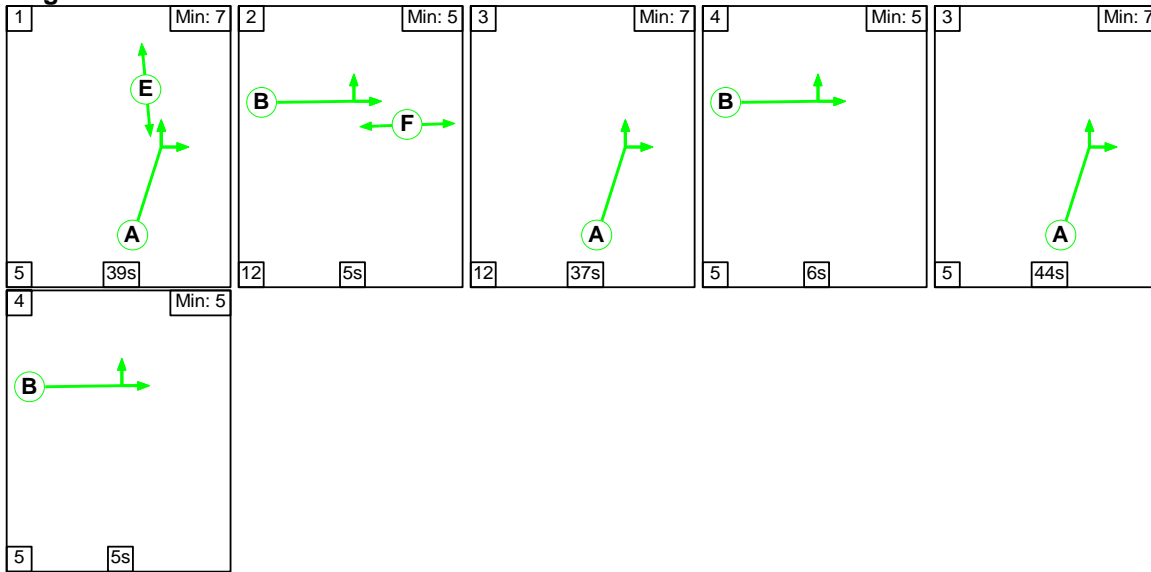

Stage Stream: 2

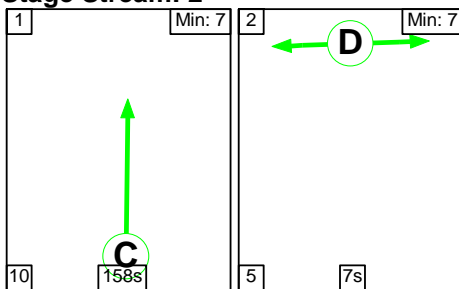

Stage Timings

Stage Stream: 1

Stage	1	2	3	4	3	4
Duration	39	5	37	6	44	5
Change Point	0	44	61	110	121	170

Stage Stream: 2

Stage	1	2
Duration	158	7
Change Point	5	173

Signal Timings Diagram

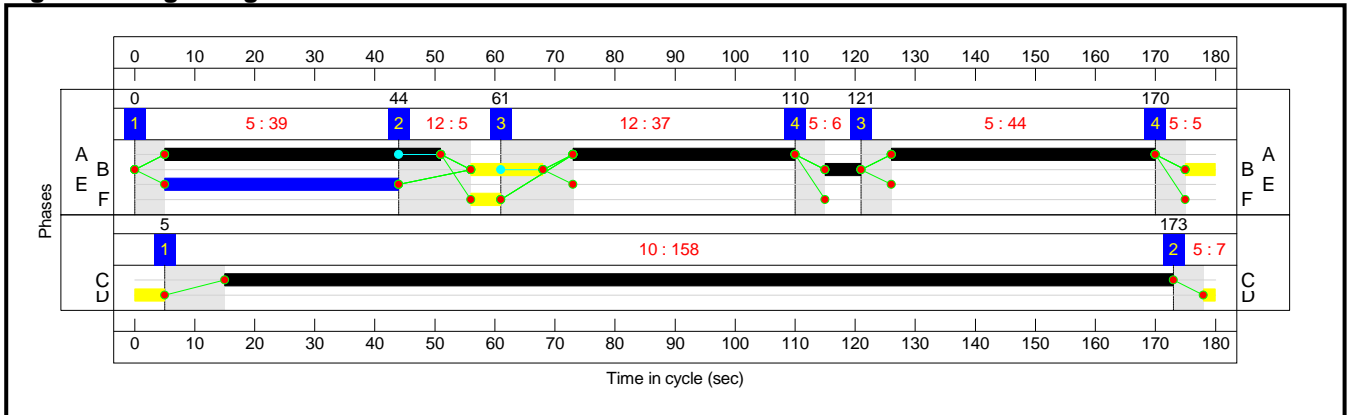

C2 Stage Sequence Diagram Stage Stream: 1

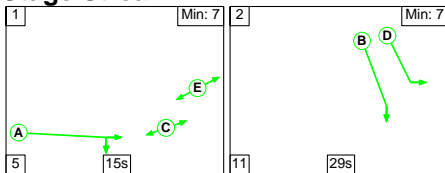

Stage Stream: 2

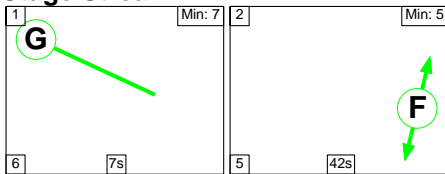

Stage Timings Stage Stream: 1

Stage	1	2	1	2	1	2
Duration	15	29	15	29	15	29
Change Point	100	120	160	0	40	60

Stage Stream: 2

Stage	1	2	1	2	1	2
Duration	7	42	7	42	7	42
Change Point	0	13	60	73	120	133

Signal Timings Diagram

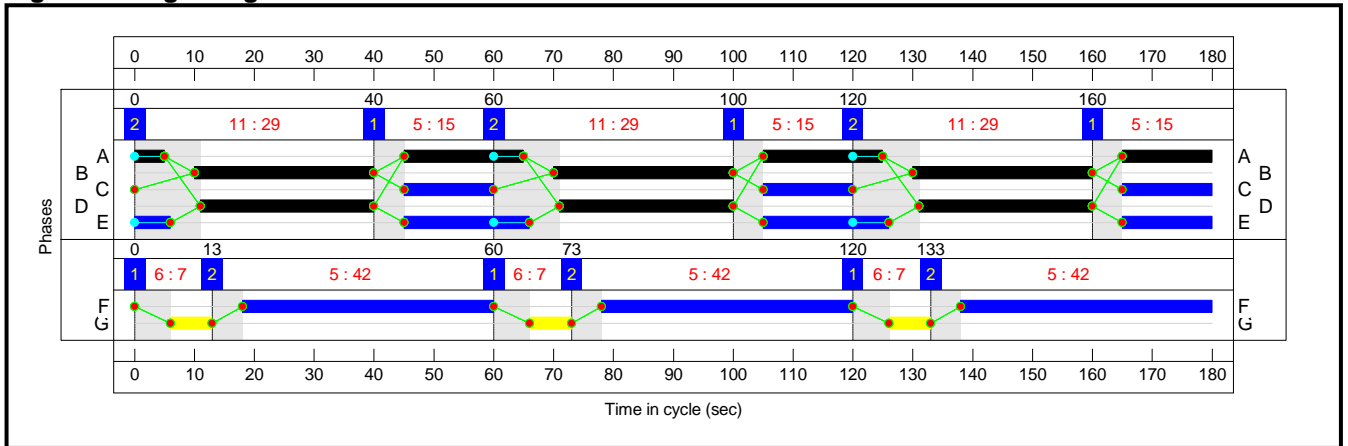

**C3
 Stage Sequence Diagram**

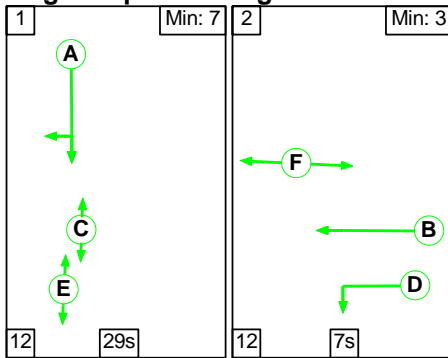

Stage Timings

Stage	1	2	1	2	1	2
Duration	29	7	29	7	29	7
Change Point	4	45	64	105	124	165

Signal Timings Diagram

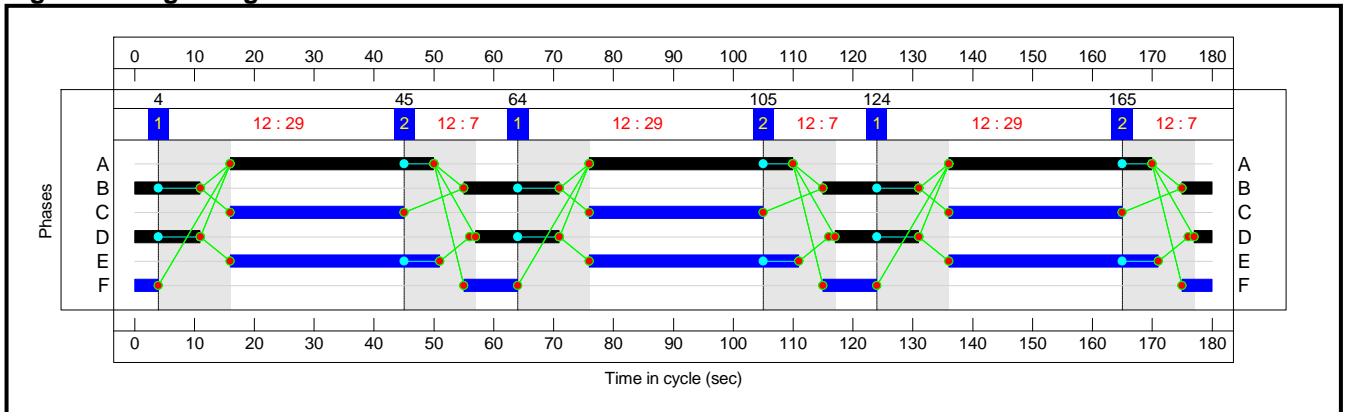

C4
Stage Sequence Diagram

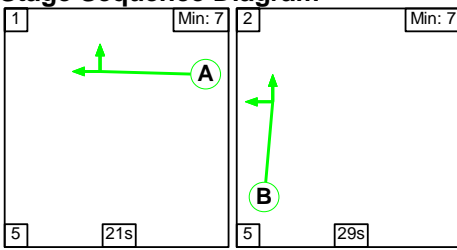

Stage Timings

Stage	1	2	1	2	1	2
Duration	21	29	21	29	21	29
Change Point	109	135	169	15	49	75

Signal Timings Diagram

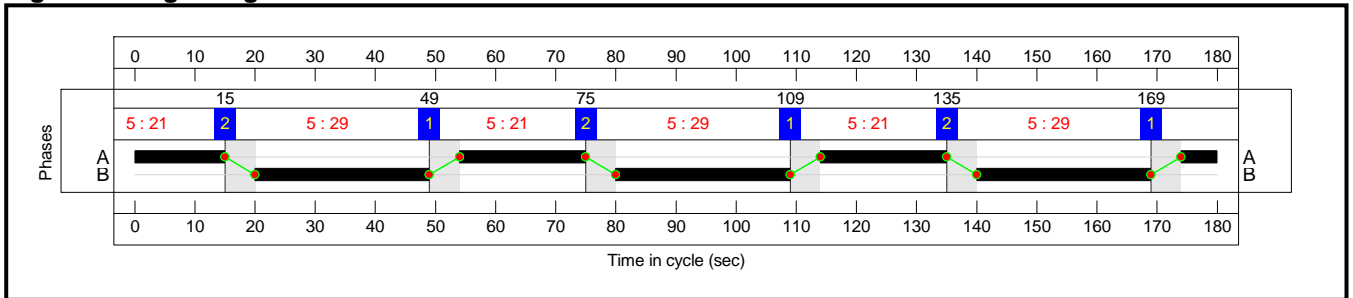

Network Layout Diagram

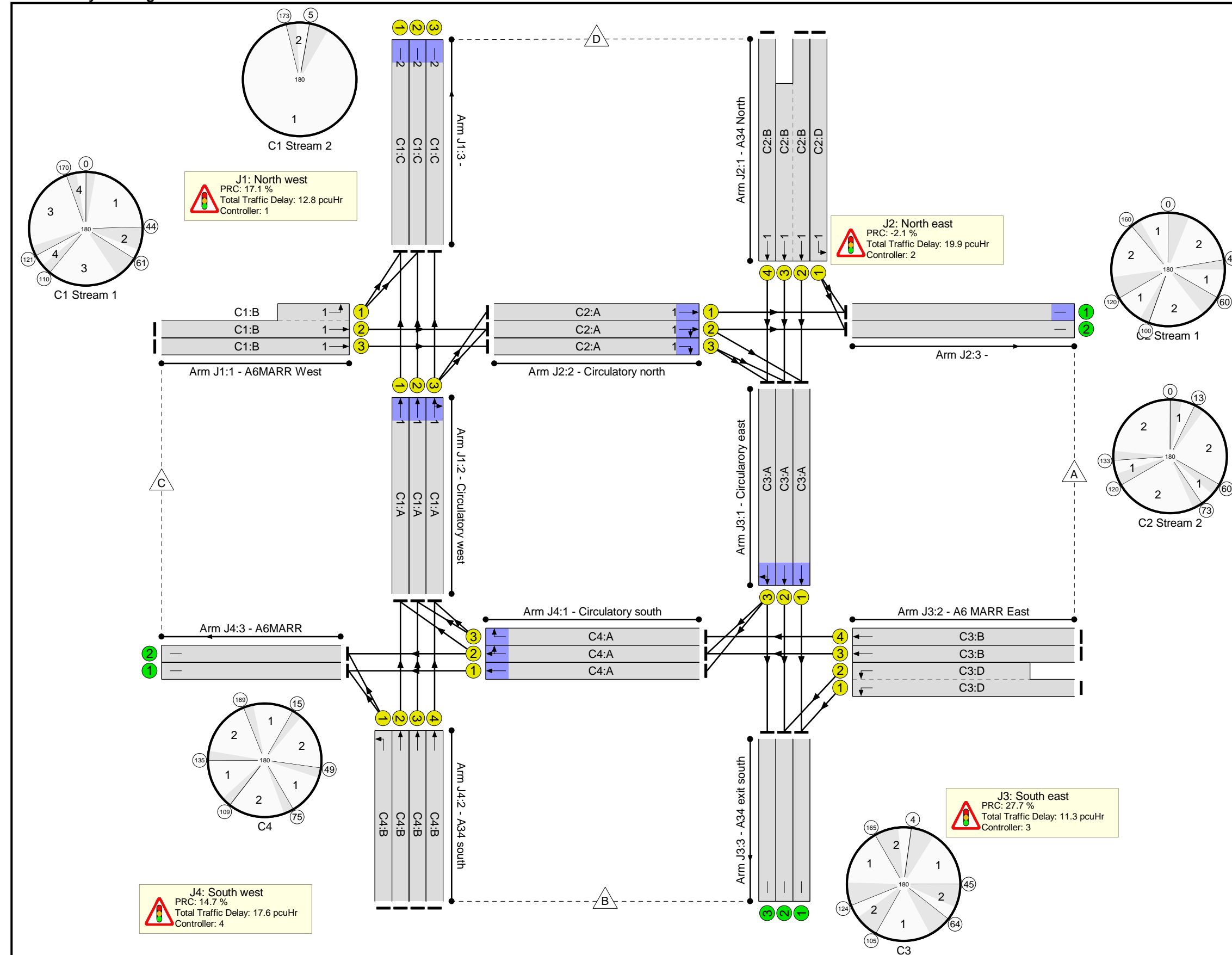

Network Results

Item	Lane Description	Lane Type	Controller Stream	Position In Filtered Route	Full Phase	Arrow Phase	Num Greens	Total Green (s)	Arrow Green (s)	Demand Flow (pcu)	Sat Flow (pcu/Hr)	Capacity (pcu)	Deg Sat (%)
Network: A34/A6MARR	-	-	N/A	-	-		-	-	-	-	-	-	91.9%
J1: North west	-	-	N/A	-	-		-	-	-	-	-	-	76.8%
1/2+1/1	A6MARR West Ahead Left	U	1:1	N/A	C1:B		3	23	-	322	2130:2053	182+287	68.7 : 68.7%
1/3	A6MARR West Ahead	U	1:1	N/A	C1:B		3	23	-	126	2130	308	41.0%
2/1	Circulatory west Ahead	U	1:1	N/A	C1:A		3	127	-	1182	2130	1538	76.8%
2/2	Circulatory west Ahead	U	1:1	N/A	C1:A		3	127	-	1002	2130	1538	65.1%
2/3	Circulatory west Right Ahead	U	1:1	N/A	C1:A		3	127	-	1001	2099	1516	66.0%
3/1		U	1:2	N/A	C1:C		1	158	-	1379	2130	1882	73.3%
3/2		U	1:2	N/A	C1:C		1	158	-	1002	2130	1882	53.3%
3/3		U	1:2	N/A	C1:C		1	158	-	508	2105	1859	27.3%
J2: North east	-	-	N/A	-	-		-	-	-	-	-	-	91.9%
1/1	A34 North Left	U	2:1	N/A	C2:D		3	87	-	881	1918	959	91.9%
1/2+1/3	A34 North Ahead	U	2:1	N/A	C2:B		3	90	-	1449	1990:2130	1028+1027	70.5 : 70.5%
1/4	A34 North Ahead	U	2:1	N/A	C2:B		3	90	-	730	1990	1028	71.0%
2/1	Circulatory north Ahead	U	2:1	N/A	C2:A		3	60	-	247	2099	735	33.6%
2/2	Circulatory north Right Ahead	U	2:1	N/A	C2:A		3	60	-	371	2088	731	50.8%
2/3	Circulatory north Right	U	2:1	N/A	C2:A		3	60	-	126	2068	724	17.4%

Item	Lane Description	Lane Type	Controller Stream	Position In Filtered Route	Full Phase	Arrow Phase	Num Greens	Total Green (s)	Arrow Green (s)	Demand Flow (pcu)	Sat Flow (pcu/Hr)	Capacity (pcu)	Deg Sat (%)
3/1		U	N/A	N/A	-		-	-	-	687	Inf	Inf	0.0%
3/2		U	N/A	N/A	-		-	-	-	687	Inf	Inf	0.0%
J3: South east	-	-	N/A	-	-		-	-	-	-	-	-	70.5%
1/1	Circularory east Ahead	U	N/A	N/A	C3:A		3	102	-	850	2068	1206	70.5%
1/2	Circularory east Ahead	U	N/A	N/A	C3:A		3	102	-	787	2068	1206	65.2%
1/3	Circularory east Ahead Right	U	N/A	N/A	C3:A		3	102	-	793	2058	1200	66.1%
2/1+2/2	A6 MARR East Left	U	N/A	N/A	C3:D		3	42	-	323	1967:2029	492+507	32.7 : 31.9%
2/3	A6 MARR East Ahead	U	N/A	N/A	C3:B		3	48	-	362	1990	564	64.2%
2/4	A6 MARR East Ahead	U	N/A	N/A	C3:B		3	48	-	362	2130	604	60.0%
3/1	A34 exit south	U	N/A	N/A	-		-	-	-	1011	Inf	Inf	0.0%
3/2	A34 exit south	U	N/A	N/A	-		-	-	-	949	Inf	Inf	0.0%
3/3	A34 exit south	U	N/A	N/A	-		-	-	-	599	Inf	Inf	0.0%
J4: South west	-	-	N/A	-	-		-	-	-	-	-	-	78.5%
1/1	Circulatory south Ahead	U	N/A	N/A	C4:A		3	63	-	104	2099	770	13.5%
1/2	Circulatory south Right Ahead	U	N/A	N/A	C4:A		3	63	-	452	2062	756	59.8%
1/3	Circulatory south Right	U	N/A	N/A	C4:A		3	63	-	362	2053	753	48.1%
2/1	A34 south Left	U	N/A	N/A	C4:B		3	87	-	291	2082	1041	28.0%
2/2	A34 south Ahead	U	N/A	N/A	C4:B		3	87	-	820	2092	1046	78.4%
2/3	A34 south Ahead	U	N/A	N/A	C4:B		3	87	-	821	2092	1046	78.5%

Item	Lane Description	Lane Type	Controller Stream	Position In Filtered Route	Full Phase	Arrow Phase	Num Greens	Total Green (s)	Arrow Green (s)	Demand Flow (pcu)	Sat Flow (pcu/Hr)	Capacity (pcu)	Deg Sat (%)
2/4	A34 south Ahead	U	N/A	N/A	C4:B		3	87	-	820	2092	1046	78.4%
3/1	A6MARR	U	N/A	N/A	-		-	-	-	249	Inf	Inf	0.0%
3/2	A6MARR	U	N/A	N/A	-		-	-	-	236	Inf	Inf	0.0%

Item	Arriving (pcu)	Leaving (pcu)	Turners In Gaps (pcu)	Turners When Unopposed (pcu)	Turners In Intergreen (pcu)	Uniform Delay (pcuHr)	Rand + Oversat Delay (pcuHr)	Storage Area Uniform Delay (pcuHr)	Total Delay (pcuHr)	Av. Delay Per PCU (s/pcu)	Max. Back of Uniform Queue (pcu)	Rand + Oversat Queue (pcu)	Mean Max Queue (pcu)
Network: A34/A6MARR	-	-	0	0	0	34.4	27.2	0.0	61.6	-	-	-	-
J1: North west	-	-	0	0	0	5.8	7.1	0.0	12.8	-	-	-	-
1/2+1/1	322	322	-	-	-	2.2	1.1	-	3.2	36.1	3.3	1.1	4.4
1/3	126	126	-	-	-	0.8	0.3	-	1.2	33.4	2.0	0.3	2.4
2/1	1182	1182	-	-	-	0.7	1.6	-	2.3	7.0	7.5	1.6	9.2
2/2	1002	1002	-	-	-	0.5	0.9	-	1.5	5.2	4.0	0.9	4.9
2/3	1001	1001	-	-	-	0.5	1.0	-	1.5	5.4	4.1	1.0	5.1
3/1	1379	1379	-	-	-	0.9	1.4	-	2.2	5.8	22.2	1.4	23.6
3/2	1002	1002	-	-	-	0.2	0.6	-	0.7	2.6	4.4	0.6	4.9
3/3	508	508	-	-	-	0.1	0.2	-	0.2	1.7	2.0	0.2	2.1
J2: North east	-	-	0	0	0	11.6	8.3	0.0	19.9	-	-	-	-
1/1	881	881	-	-	-	3.4	5.0	-	8.4	34.3	13.5	5.0	18.5
1/2+1/3	1449	1449	-	-	-	4.4	1.2	-	5.5	13.8	9.1	1.2	10.3
1/4	730	730	-	-	-	2.2	1.2	-	3.5	17.1	9.1	1.2	10.3
2/1	247	247	-	-	-	0.5	0.3	-	0.8	11.2	3.1	0.3	3.3
2/2	371	371	-	-	-	0.8	0.5	-	1.3	12.9	3.9	0.5	4.4
2/3	126	126	-	-	-	0.3	0.1	-	0.4	10.5	0.7	0.1	0.8
3/1	687	687	-	-	-	0.0	0.0	-	0.0	0.0	0.0	0.0	0.0
3/2	687	687	-	-	-	0.0	0.0	-	0.0	0.0	0.0	0.0	0.0
J3: South east	-	-	0	0	0	6.3	5.0	0.0	11.3	-	-	-	-
1/1	850	850	-	-	-	0.4	1.2	-	1.6	6.8	3.7	1.2	4.9
1/2	787	787	-	-	-	0.2	0.9	-	1.2	5.4	1.4	0.9	2.3

Item	Arriving (pcu)	Leaving (pcu)	Turners In Gaps (pcu)	Turners When Unopposed (pcu)	Turners In Intergreen (pcu)	Uniform Delay (pcuHr)	Rand + Oversat Delay (pcuHr)	Storage Area Uniform Delay (pcuHr)	Total Delay (pcuHr)	Av. Delay Per PCU (s/pcu)	Max. Back of Uniform Queue (pcu)	Rand + Oversat Queue (pcu)	Mean Max Queue (pcu)	
1/3	793	793	-	-	-	0.2	1.0	-	1.2	5.5	1.4	1.0	2.4	
2/1+2/2	323	323	-	-	-	1.6	0.2	-	1.9	21.0	2.2	0.2	2.4	
2/3	362	362	-	-	-	1.9	0.9	-	2.8	27.7	5.2	0.9	6.1	
2/4	362	362	-	-	-	1.9	0.7	-	2.6	26.0	5.1	0.7	5.9	
3/1	1011	1011	-	-	-	0.0	0.0	-	0.0	0.0	0.0	0.0	0.0	
3/2	949	949	-	-	-	0.0	0.0	-	0.0	0.0	0.0	0.0	0.0	
3/3	599	599	-	-	-	0.0	0.0	-	0.0	0.0	0.0	0.0	0.0	
J4: South west	-	-	0	0	0	10.8	6.8	0.0	17.6	-	-	-	-	
1/1	104	104	-	-	-	0.5	0.1	-	0.6	20.9	1.7	0.1	1.8	
1/2	452	452	-	-	-	0.8	0.7	-	1.5	12.2	2.0	0.7	2.8	
1/3	362	362	-	-	-	0.3	0.5	-	0.8	7.6	0.5	0.5	1.0	
2/1	291	291	-	-	-	0.7	0.2	-	0.9	11.1	2.7	0.2	2.9	
2/2	820	820	-	-	-	2.8	1.8	-	4.6	20.2	11.2	1.8	12.9	
2/3	821	821	-	-	-	2.8	1.8	-	4.6	20.2	11.2	1.8	13.0	
2/4	820	820	-	-	-	2.8	1.8	-	4.6	20.2	11.2	1.8	12.9	
3/1	249	249	-	-	-	0.0	0.0	-	0.0	0.0	0.0	0.0	0.0	
3/2	236	236	-	-	-	0.0	0.0	-	0.0	0.0	0.0	0.0	0.0	
			C1 Stream: 1 PRC for Signalled Lanes (%)	17.1	Total Delay for Signalled Lanes (pcuHr):			9.67	Cycle Time (s):			180		
			C1 Stream: 2 PRC for Signalled Lanes (%)	22.8	Total Delay for Signalled Lanes (pcuHr):			3.18	Cycle Time (s):			180		
			C2 Stream: 1 PRC for Signalled Lanes (%)	-2.1	Total Delay for Signalled Lanes (pcuHr):			19.87	Cycle Time (s):			180		
			C2 Stream: 2 PRC for Signalled Lanes (%)	0.0	Total Delay for Signalled Lanes (pcuHr):			0.00	Cycle Time (s):			180		
			C3 PRC for Signalled Lanes (%)	27.7	Total Delay for Signalled Lanes (pcuHr):			11.28	Cycle Time (s):			180		
			C4 PRC for Signalled Lanes (%)	14.7	Total Delay for Signalled Lanes (pcuHr):			17.59	Cycle Time (s):			180		
			PRC Over All Lanes (%)	-2.1	Total Delay Over All Lanes (pcuHr):			61.59						

Appendix F.7

A34/ B5094 Stanley Road LinSig Output

A34/ B5094 Stanley Road LinSig Output

Full Input Data And Results

User and Project Details

Project:	A6MARR
Title:	A34/Stanley Road
Location:	
File name:	5.5- A34_StanleyGreen.lsg3x
Author:	PW
Company:	Atkins
Address:	Bank Chambers, Faulkner Street, Manchester
Notes:	

Network Layout Diagram

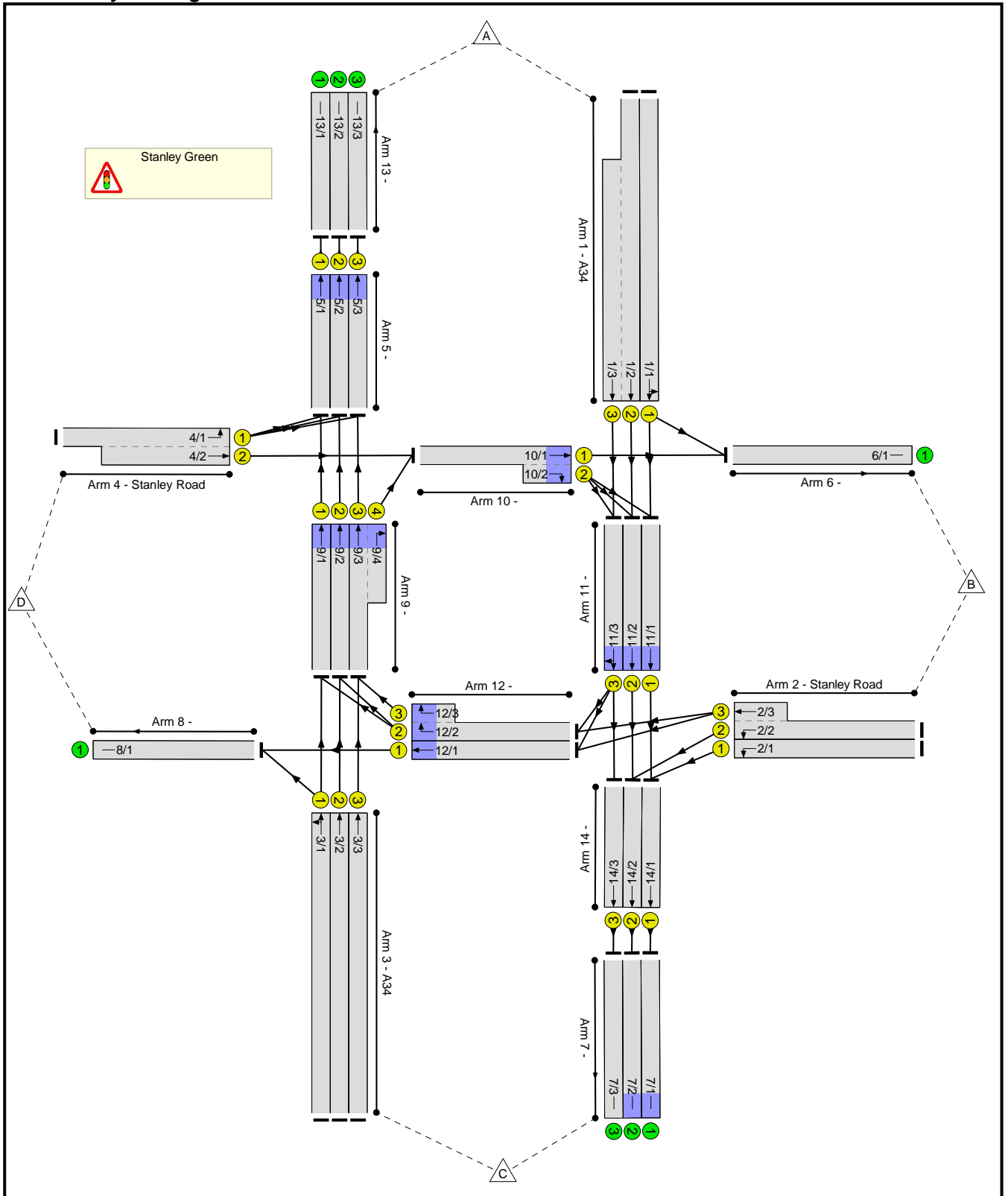

Phase Diagram

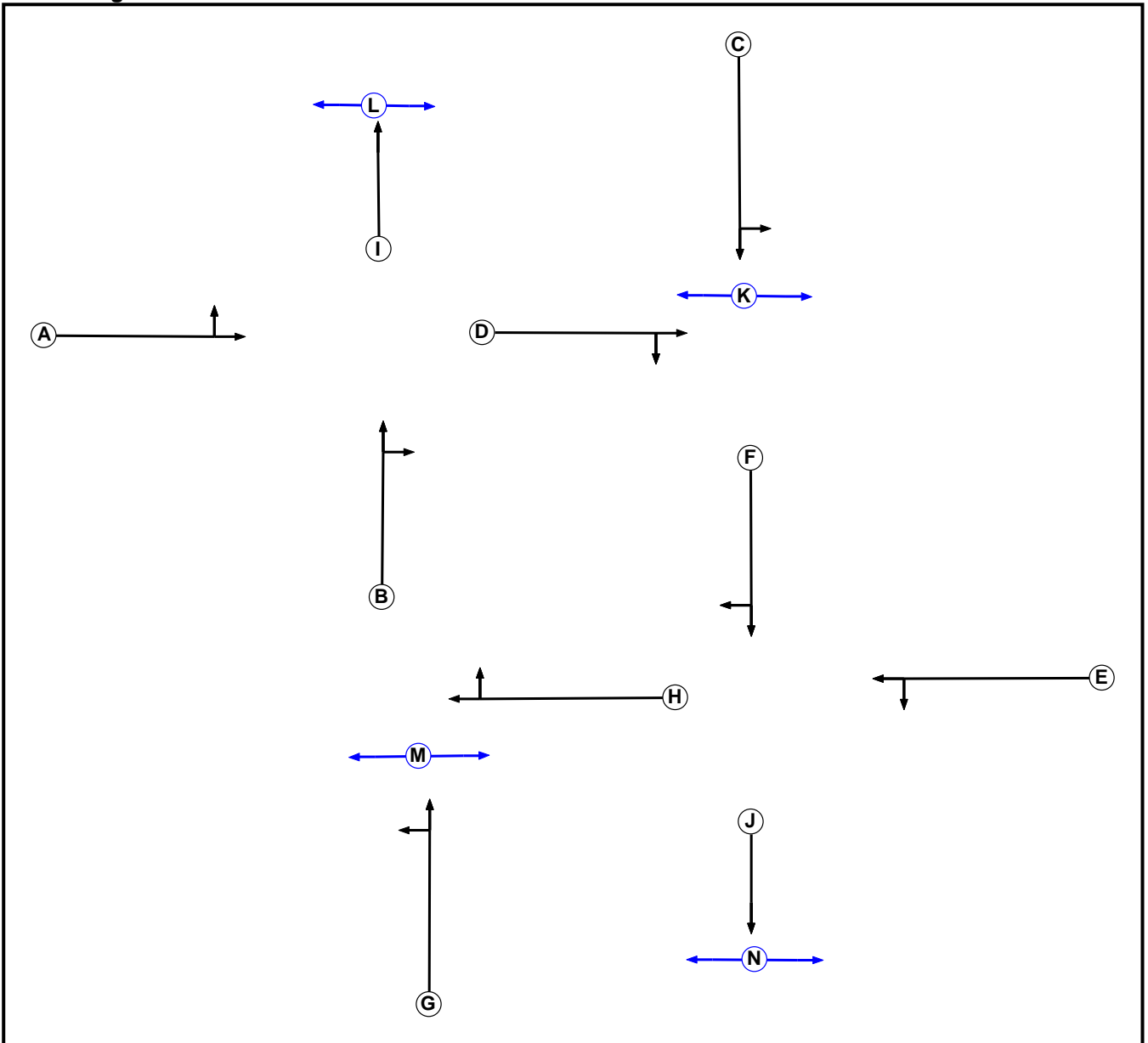

Phase Input Data

Phase Name	Phase Type	Stage Stream	Assoc. Phase	Street Min	Cont Min
A	Traffic	1		7	7
B	Traffic	1		7	7
C	Traffic	2		7	7
D	Traffic	2		7	2
E	Traffic	3		7	7
F	Traffic	3		7	7
G	Traffic	4		7	7
H	Traffic	4		7	2
I	Traffic	5		7	7
J	Traffic	6		7	7
K	Pedestrian	2		7	7
L	Pedestrian	5		7	7
M	Pedestrian	4		7	7
N	Pedestrian	6		5	5

Phase Intergreens Matrix

		Starting Phase													
		A	B	C	D	E	F	G	H	I	J	K	L	M	N
Terminating Phase	A		5	-	-	-	-	-	-	-	-	-	-	-	-
	B	5		-	-	-	-	-	-	-	-	-	-	-	-
	C	-	-		5	-	-	-	-	-	-	5	-	-	-
	D	-	-	5		-	-	-	-	-	-	-	-	-	-
	E	-	-	-	-		5	-	-	-	-	-	-	-	-
	F	-	-	-	-	5		-	-	-	-	-	-	-	-
	G	-	-	-	-	-	-		5	-	-	-	-	5	-
	H	-	-	-	-	-	-	5		-	-	-	-	-	-
	I	-	-	-	-	-	-	-	-		-	-	5	-	-
	J	-	-	-	-	-	-	-	-	-		-	-	-	5
	K	-	-	10	-	-	-	-	-	-	-		-	-	-
	L	-	-	-	-	-	-	-	-	10	-	-		-	-
	M	-	-	-	-	-	-	10	-	-	-	-	-		-
	N	-	-	-	-	-	-	-	-	-	7	-	-	-	

Phases in Stage

Stream	Stage No.	Phases in Stage
1	1	A
1	2	B
2	1	C
2	2	D K
3	1	E
3	2	F
4	1	G
4	2	H M
5	1	I
5	2	L
6	1	J
6	2	N

Stage Diagram
Stage Stream: 1

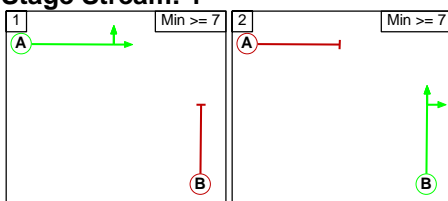

Stage Stream: 2

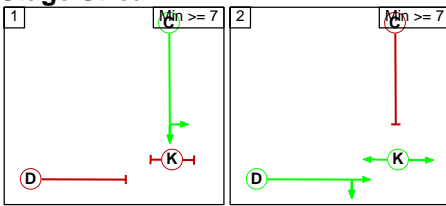

Stage Stream: 3

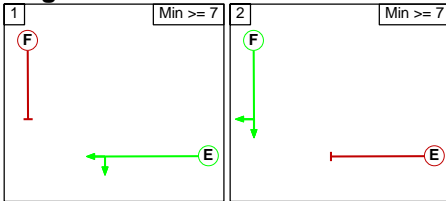

Stage Stream: 4

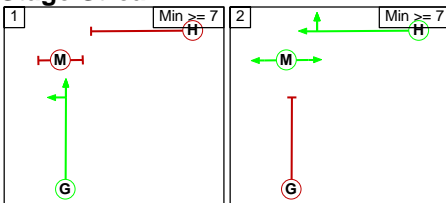

Stage Stream: 5

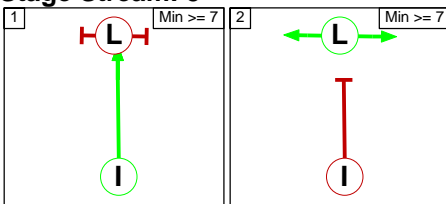

Stage Stream: 6

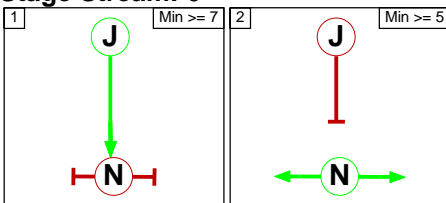

Phase Delays

Stage Stream: 1

Term. Stage	Start Stage	Phase	Type	Value	Cont value
There are no Phase Delays defined					

Stage Stream: 2

Term. Stage	Start Stage	Phase	Type	Value	Cont value
2	1	D	Losing	5	5

Stage Stream: 3

Term. Stage	Start Stage	Phase	Type	Value	Cont value
There are no Phase Delays defined					

Stage Stream: 4

Term. Stage	Start Stage	Phase	Type	Value	Cont value
2	1	H	Losing	5	5

Stage Stream: 5

Term. Stage	Start Stage	Phase	Type	Value	Cont value
There are no Phase Delays defined					

Stage Stream: 6

Term. Stage	Start Stage	Phase	Type	Value	Cont value
There are no Phase Delays defined					

Prohibited Stage Change

Stage Stream: 1

		To Stage	
		1	2
From Stage	1		5
	2	5	

Stage Stream: 2

		To Stage	
		1	2
From Stage	1		5
	2	10	

Stage Stream: 3

		To Stage	
		1	2
From Stage	1		5
	2	5	

Stage Stream: 4

		To Stage	
		1	2
From Stage	1		5
	2	10	

Stage Stream: 5

	To Stage	
	1	2
From Stage	1	5
	2	10

Stage Stream: 6

	To Stage	
	1	2
From Stage	1	5
	2	7

Give-Way Lane Input Data

Junction: Stanley Green
There are no Opposed Lanes in this Junction

Lane Input Data

Junction: Stanley Green												
Lane	Lane Type	Phases	Start Disp.	End Disp.	Physical Length (PCU)	Sat Flow Type	Def User Saturation Flow (PCU/Hr)	Lane Width (m)	Gradient	Nearside Lane	Turns	Turning Radius (m)
1/1 (A34)	U	C	2	3	60.0	Geom	-	3.50	0.00	Y	Arm 6 Left	45.00
											Arm 11 Ahead	Inf
1/2 (A34)	U	C	2	3	60.0	Geom	-	3.75	0.00	N	Arm 11 Ahead	Inf
1/3 (A34)	U	C	2	3	39.1	Geom	-	3.50	0.00	Y	Arm 11 Ahead	Inf
2/1 (Stanley Road)	U	E	2	3	60.0	Geom	-	4.00	0.00	N	Arm 14 Left	35.00
2/2 (Stanley Road)	U	E	2	3	60.0	Geom	-	4.00	0.00	N	Arm 14 Left	35.00
2/3 (Stanley Road)	U	E	2	3	4.3	Geom	-	4.00	0.00	N	Arm 12 Ahead	Inf
3/1 (A34)	U	G	2	3	60.0	Geom	-	3.75	0.00	N	Arm 8 Left	45.00
											Arm 9 Ahead	Inf
3/2 (A34)	U	G	2	3	60.0	Geom	-	3.75	0.00	N	Arm 9 Ahead	Inf
3/3 (A34)	U	G	2	3	60.0	Geom	-	3.75	0.00	N	Arm 9 Ahead	Inf
4/1 (Stanley Road)	U	A	2	3	60.0	Geom	-	3.50	0.00	N	Arm 5 Left	25.00
4/2 (Stanley Road)	U	A	2	3	10.4	Geom	-	3.50	0.00	N	Arm 10 Ahead	Inf
5/1	U	I	2	3	60.0	Geom	-	4.00	0.00	Y	Arm 13 Ahead	Inf
5/2	U	I	2	3	60.0	Geom	-	4.00	0.00	N	Arm 13 Ahead	Inf
5/3	U	I	2	3	60.0	Geom	-	4.00	0.00	Y	Arm 13 Ahead	Inf
6/1	U		2	3	60.0	Inf	-	-	-	-	-	-
7/1	U		2	3	60.0	Inf	-	-	-	-	-	-
7/2	U		2	3	60.0	Inf	-	-	-	-	-	-
7/3	U		2	3	60.0	Inf	-	-	-	-	-	-
8/1	U		2	3	60.0	Inf	-	-	-	-	-	-

9/1	U	B	2	3	60.0	Geom	-	4.00	0.00	N	Arm 5 Ahead	Inf
9/2	U	B	2	3	60.0	Geom	-	4.00	0.00	N	Arm 5 Ahead	Inf
9/3	U	B	2	3	60.0	Geom	-	4.00	0.00	N	Arm 5 Ahead	Inf
9/4	U	B	2	3	6.4	Geom	-	4.00	0.00	N	Arm 10 Right	10.00
10/1	U	D	2	3	60.0	Geom	-	4.00	0.00	N	Arm 6 Ahead	45.00
10/2	U	D	2	3	3.9	Geom	-	4.00	0.00	N	Arm 11 Right	5.00
11/1	U	F	2	3	60.0	Geom	-	4.00	0.00	N	Arm 14 Ahead	Inf
11/2	U	F	2	3	60.0	Geom	-	4.00	0.00	N	Arm 14 Ahead	Inf
11/3	U	F	2	3	60.0	Geom	-	4.00	0.00	N	Arm 12 Right	22.50
											Arm 14 Ahead	Inf
12/1	U	H	2	3	60.0	Geom	-	4.00	0.00	N	Arm 8 Ahead	30.00
12/2	U	H	2	3	60.0	Geom	-	4.00	0.00	N	Arm 9 Right	20.00
12/3	U	H	2	3	3.5	Geom	-	4.00	0.00	N	Arm 9 Right	20.00
13/1	U		2	3	60.0	Inf	-	-	-	-	-	-
13/2	U		2	3	60.0	Inf	-	-	-	-	-	-
13/3	U		2	3	60.0	Inf	-	-	-	-	-	-
14/1	U	J	2	3	60.0	Geom	-	4.00	0.00	Y	Arm 7 Ahead	Inf
14/2	U	J	2	3	60.0	Geom	-	4.00	0.00	N	Arm 7 Ahead	Inf
14/3	U	J	2	3	60.0	Geom	-	4.00	0.00	Y	Arm 7 Ahead	Inf

Traffic Flow Groups

Flow Group	Start Time	End Time	Duration	Formula
1: 'AM 2017'	08:00	09:00	01:00	
2: 'PM 2017'	08:00	09:00	01:00	

Scenario 1: 'AM 2017' (FG1: 'AM 2017', Plan 1: 'Plan1')
Traffic Flows, Desired
Desired Flow :

		Destination				
		A	B	C	D	Tot.
Origin	A	0	281	2235	201	2717
	B	476	0	935	152	1563
	C	2360	488	0	91	2939
	D	125	63	33	0	221
	Tot.	2961	832	3203	444	7440

Traffic Lane Flows

Lane	Scenario 1: AM 2017
Junction: Stanley Green	
1/1	855
1/2 (with short)	1862(In) 956(Out)
1/3 (short)	906
2/1	640
2/2 (with short)	923(In) 295(Out)
2/3 (short)	628
3/1	972
3/2	987
3/3	980
4/1 (with short)	221(In) 125(Out)
4/2 (short)	96
5/1	953
5/2	1061
5/3	947
6/1	832
7/1	1214
7/2	1251
7/3	738
8/1	444

Lane	Scenario 1: AM 2017
Junction: Stanley Green	
9/1	951
9/2	1056
9/3 (with short)	1317(In) 829(Out)
9/4 (short)	488
10/1 (with short)	584(In) 551(Out)
10/2 (short)	33
11/1	574
11/2	956
11/3	939
12/1	353
12/2 (with short)	476(In) 139(Out)
12/3 (short)	337
13/1	953
13/2	1061
13/3	947
14/1	1214
14/2	1251
14/3	738

Lane Saturation Flows

Junction: Stanley Green								
Lane	Lane Width (m)	Gradient	Nearside Lane	Allowed Turns	Turning Radius (m)	Turning Prop.	Sat Flow (PCU/Hr)	Flared Sat Flow (PCU/Hr)
1/1 (A34)	3.50	0.00	Y	Arm 6 Left	45.00	32.9 %	1944	1944
				Arm 11 Ahead	Inf	67.1 %		
1/2 (A34)	3.75	0.00	N	Arm 11 Ahead	Inf	100.0 %	2130	2130
1/3 (A34)	3.50	0.00	Y	Arm 11 Ahead	Inf	100.0 %	1965	1965
2/1 (Stanley Road)	4.00	0.00	N	Arm 14 Left	35.00	100.0 %	2066	2066
2/2 (Stanley Road)	4.00	0.00	N	Arm 14 Left	35.00	100.0 %	2066	2066
2/3 (Stanley Road)	4.00	0.00	N	Arm 12 Ahead	Inf	100.0 %	2155	2155
3/1 (A34)	3.75	0.00	N	Arm 8 Left	45.00	9.4 %	2123	2123
				Arm 9 Ahead	Inf	90.6 %		
3/2 (A34)	3.75	0.00	N	Arm 9 Ahead	Inf	100.0 %	2130	2130
3/3 (A34)	3.75	0.00	N	Arm 9 Ahead	Inf	100.0 %	2130	2130
4/1 (Stanley Road)	3.50	0.00	N	Arm 5 Left	25.00	100.0 %	1986	1986
4/2 (Stanley Road)	3.50	0.00	N	Arm 10 Ahead	Inf	100.0 %	2105	2105
5/1	4.00	0.00	Y	Arm 13 Ahead	Inf	100.0 %	2015	2015
5/2	4.00	0.00	N	Arm 13 Ahead	Inf	100.0 %	2155	2155
5/3	4.00	0.00	Y	Arm 13 Ahead	Inf	100.0 %	2015	2015
6/1	Infinite Saturation Flow						Inf	Inf
7/1	Infinite Saturation Flow						Inf	Inf
7/2	Infinite Saturation Flow						Inf	Inf
7/3	Infinite Saturation Flow						Inf	Inf
8/1	Infinite Saturation Flow						Inf	Inf
9/1	4.00	0.00	N	Arm 5 Ahead	Inf	100.0 %	2155	2155
9/2	4.00	0.00	N	Arm 5 Ahead	Inf	100.0 %	2155	2155
9/3	4.00	0.00	N	Arm 5 Ahead	Inf	100.0 %	2155	2155
9/4	4.00	0.00	N	Arm 10 Right	10.00	100.0 %	1874	1874
10/1	4.00	0.00	N	Arm 6 Ahead	45.00	100.0 %	2085	2085
10/2	4.00	0.00	N	Arm 11 Right	5.00	100.0 %	1658	1658
11/1	4.00	0.00	N	Arm 14 Ahead	Inf	100.0 %	2155	2155

11/2	4.00	0.00	N	Arm 14 Ahead	Inf	100.0 %	2155	2155
11/3	4.00	0.00	N	Arm 12 Right	22.50	21.4 %	2125	2125
				Arm 14 Ahead	Inf	78.6 %		
12/1	4.00	0.00	N	Arm 8 Ahead	30.00	100.0 %	2052	2052
12/2	4.00	0.00	N	Arm 9 Right	20.00	100.0 %	2005	2005
12/3	4.00	0.00	N	Arm 9 Right	20.00	100.0 %	2005	2005
13/1	Infinite Saturation Flow						Inf	Inf
13/2	Infinite Saturation Flow						Inf	Inf
13/3	Infinite Saturation Flow						Inf	Inf
14/1	4.00	0.00	Y	Arm 7 Ahead	Inf	100.0 %	2015	2015
14/2	4.00	0.00	N	Arm 7 Ahead	Inf	100.0 %	2155	2155
14/3	4.00	0.00	Y	Arm 7 Ahead	Inf	100.0 %	2015	2015

Scenario 2: 'PM 2017' (FG2: 'PM 2017', Plan 1: 'Plan1')
Traffic Flows, Desired
Desired Flow :

	Destination					
	A	B	C	D	Tot.	
Origin	A	0	506	2343	33	2882
	B	302	0	601	120	1023
	C	2392	419	0	76	2887
	D	213	132	118	0	463
	Tot.	2907	1057	3062	229	7255

Traffic Lane Flows

Lane	Scenario 2: PM 2017
Junction: Stanley Green	
1/1	908
1/2 (with short)	1974(In) 993(Out)
1/3 (short)	981
2/1	436
2/2 (with short)	587(In) 165(Out)
2/3 (short)	422
3/1	948
3/2	969
3/3	970

Lane	Scenario 2: PM 2017
Junction: Stanley Green	
4/1 (with short)	463(In) 213(Out)
4/2 (short)	250
5/1	933
5/2	1041
5/3	933
6/1	1057
7/1	940
7/2	1158
7/3	964
8/1	229
9/1	928
9/2	1026
9/3 (with short)	1159(In) 740(Out)
9/4 (short)	419
10/1 (with short)	669(In) 551(Out)
10/2 (short)	118
11/1	504
11/2	993
11/3	997
12/1	153
12/2 (with short)	302(In) 113(Out)
12/3 (short)	189
13/1	933
13/2	1041
13/3	933
14/1	940
14/2	1158
14/3	964

Lane Saturation Flows

Junction: Stanley Green								
Lane	Lane Width (m)	Gradient	Nearside Lane	Allowed Turns	Turning Radius (m)	Turning Prop.	Sat Flow (PCU/Hr)	Flared Sat Flow (PCU/Hr)
1/1 (A34)	3.50	0.00	Y	Arm 6 Left	45.00	55.7 %	1929	1929
				Arm 11 Ahead	Inf	44.3 %		
1/2 (A34)	3.75	0.00	N	Arm 11 Ahead	Inf	100.0 %	2130	2130
1/3 (A34)	3.50	0.00	Y	Arm 11 Ahead	Inf	100.0 %	1965	1965
2/1 (Stanley Road)	4.00	0.00	N	Arm 14 Left	35.00	100.0 %	2066	2066
2/2 (Stanley Road)	4.00	0.00	N	Arm 14 Left	35.00	100.0 %	2066	2066
2/3 (Stanley Road)	4.00	0.00	N	Arm 12 Ahead	Inf	100.0 %	2155	2155
3/1 (A34)	3.75	0.00	N	Arm 8 Left	45.00	8.0 %	2124	2124
				Arm 9 Ahead	Inf	92.0 %		
3/2 (A34)	3.75	0.00	N	Arm 9 Ahead	Inf	100.0 %	2130	2130
3/3 (A34)	3.75	0.00	N	Arm 9 Ahead	Inf	100.0 %	2130	2130
4/1 (Stanley Road)	3.50	0.00	N	Arm 5 Left	25.00	100.0 %	1986	1986
4/2 (Stanley Road)	3.50	0.00	N	Arm 10 Ahead	Inf	100.0 %	2105	2105
5/1	4.00	0.00	Y	Arm 13 Ahead	Inf	100.0 %	2015	2015
5/2	4.00	0.00	N	Arm 13 Ahead	Inf	100.0 %	2155	2155
5/3	4.00	0.00	Y	Arm 13 Ahead	Inf	100.0 %	2015	2015
6/1	Infinite Saturation Flow						Inf	Inf
7/1	Infinite Saturation Flow						Inf	Inf
7/2	Infinite Saturation Flow						Inf	Inf
7/3	Infinite Saturation Flow						Inf	Inf
8/1	Infinite Saturation Flow						Inf	Inf
9/1	4.00	0.00	N	Arm 5 Ahead	Inf	100.0 %	2155	2155
9/2	4.00	0.00	N	Arm 5 Ahead	Inf	100.0 %	2155	2155
9/3	4.00	0.00	N	Arm 5 Ahead	Inf	100.0 %	2155	2155
9/4	4.00	0.00	N	Arm 10 Right	10.00	100.0 %	1874	1874
10/1	4.00	0.00	N	Arm 6 Ahead	45.00	100.0 %	2085	2085
10/2	4.00	0.00	N	Arm 11 Right	5.00	100.0 %	1658	1658
11/1	4.00	0.00	N	Arm 14 Ahead	Inf	100.0 %	2155	2155

11/2	4.00	0.00	N	Arm 14 Ahead	Inf	100.0 %	2155	2155
11/3	4.00	0.00	N	Arm 12 Right	22.50	3.3 %	2150	2150
				Arm 14 Ahead	Inf	96.7 %		
12/1	4.00	0.00	N	Arm 8 Ahead	30.00	100.0 %	2052	2052
12/2	4.00	0.00	N	Arm 9 Right	20.00	100.0 %	2005	2005
12/3	4.00	0.00	N	Arm 9 Right	20.00	100.0 %	2005	2005
13/1	Infinite Saturation Flow						Inf	Inf
13/2	Infinite Saturation Flow						Inf	Inf
13/3	Infinite Saturation Flow						Inf	Inf
14/1	4.00	0.00	Y	Arm 7 Ahead	Inf	100.0 %	2015	2015
14/2	4.00	0.00	N	Arm 7 Ahead	Inf	100.0 %	2155	2155
14/3	4.00	0.00	Y	Arm 7 Ahead	Inf	100.0 %	2015	2015

Scenario 1: 'AM 2017' (FG1: 'AM 2017', Plan 1: 'Plan1')

Stage Sequence Diagram

Stage Stream: 1

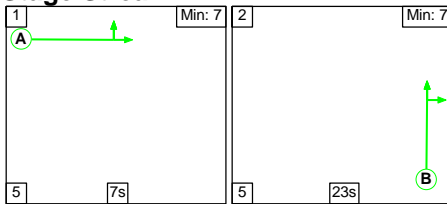

Stage Stream: 2

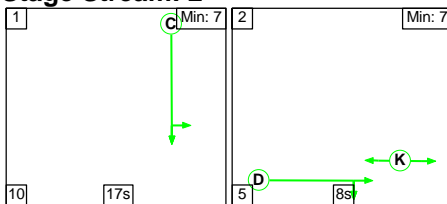

Stage Stream: 3

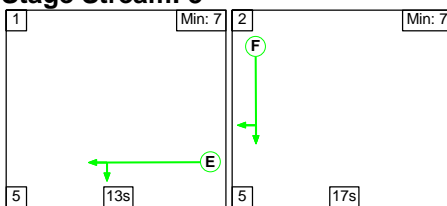

Stage Stream: 4

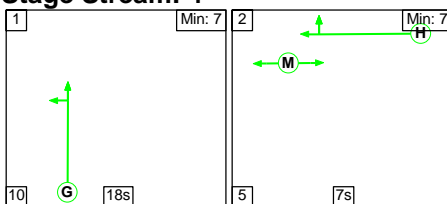

Stage Stream: 5

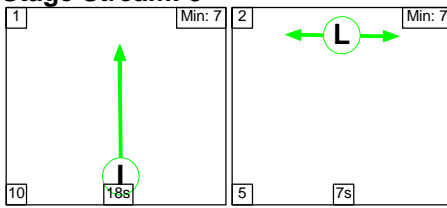

Stage Stream: 6

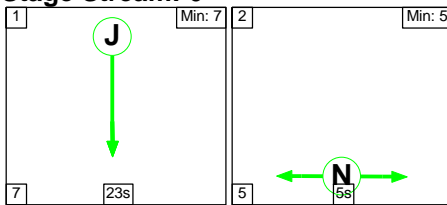

Stage Timings

Stage Stream: 1

Stage	1	2
Duration	7	23
Change Point	31	3

Stage Stream: 2

Stage	1	2
Duration	17	8
Change Point	34	21

Stage Stream: 3

Stage	1	2
Duration	13	17
Change Point	25	3

Stage Stream: 4

Stage	1	2
Duration	18	7
Change Point	38	26

Stage Stream: 5

Stage	1	2
Duration	18	7
Change Point	5	33

Stage Stream: 6

Stage	1	2
Duration	23	5
Change Point	3	33

Signal Timings Diagram

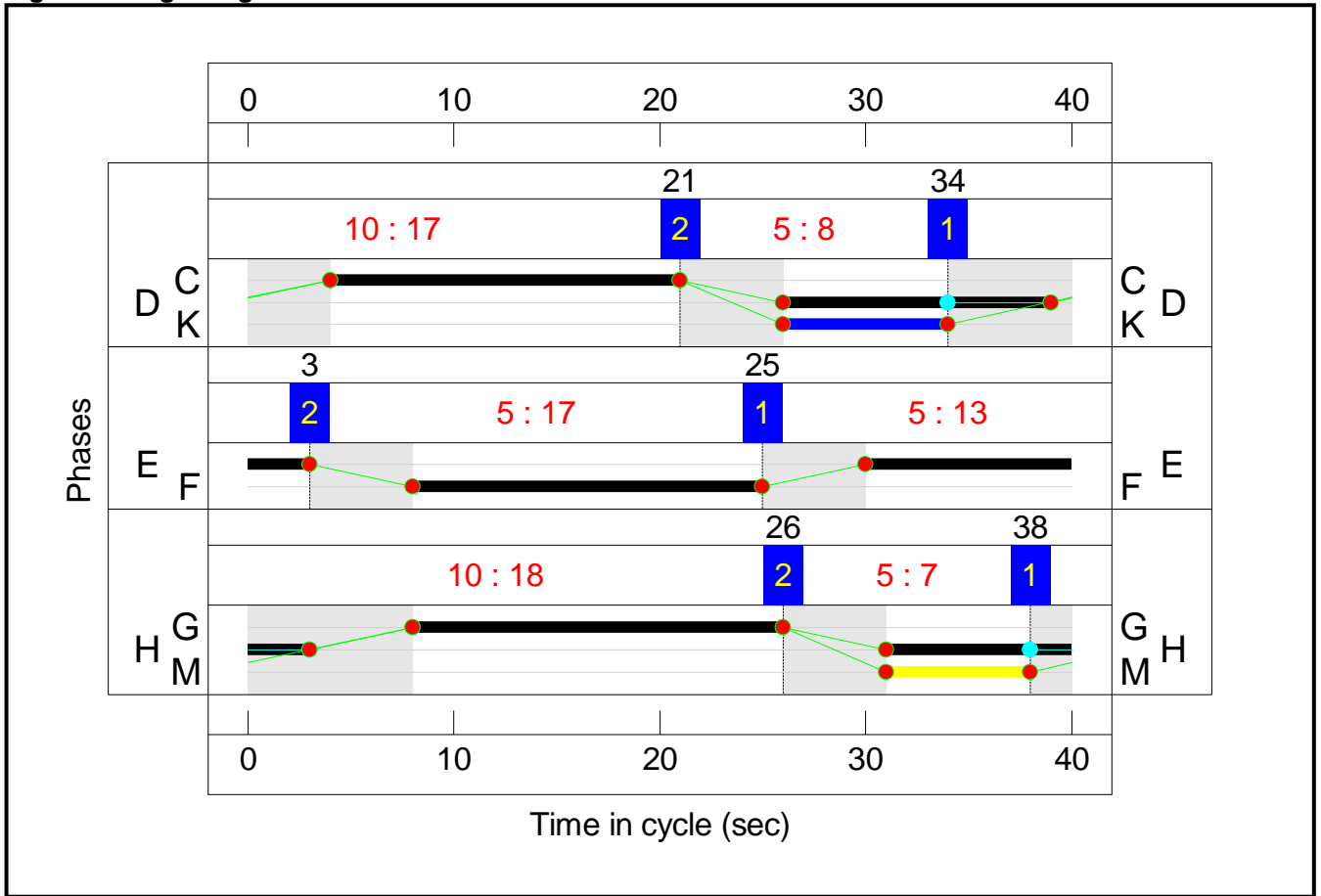

Network Layout Diagram

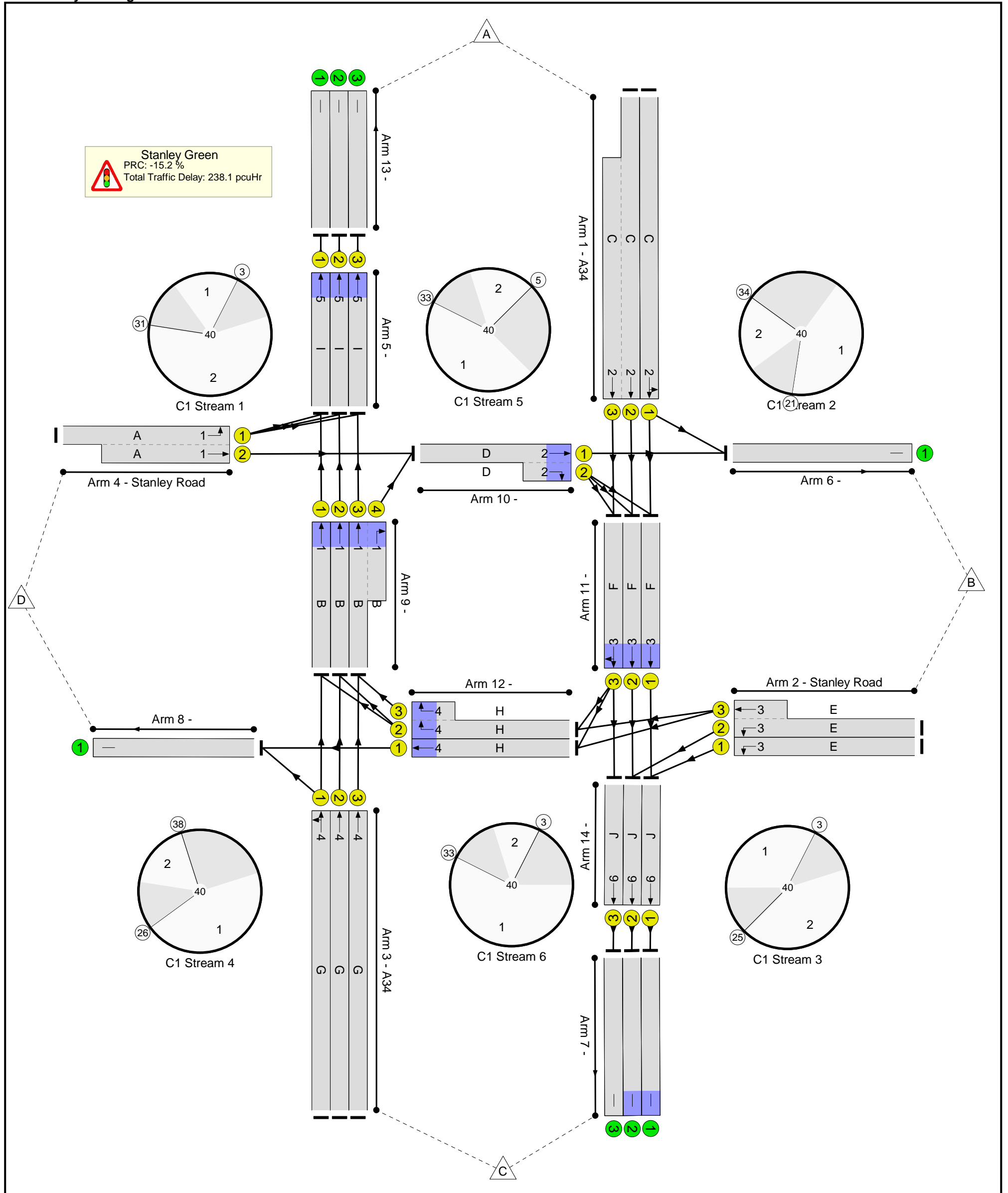

Network Results

Item	Lane Description	Lane Type	Controller Stream	Position In Filtered Route	Full Phase	Arrow Phase	Num Greens	Total Green (s)	Arrow Green (s)	Demand Flow (pcu)	Sat Flow (pcu/Hr)	Capacity (pcu)	Deg Sat (%)
Network: A34/Stanley Road	-	-	N/A	-	-		-	-	-	-	-	-	103.7%
Stanley Green	-	-	N/A	-	-		-	-	-	-	-	-	103.7%
1/1	A34 Left Ahead	U	2	N/A	C		1	17	-	855	1944	875	97.7%
1/2+1/3	A34 Ahead	U	2	N/A	C		1	17	-	1862	2130:1965	959+884	99.7 : 102.5%
2/1	Stanley Road Left	U	3	N/A	E		1	13	-	640	2066	723	88.5%
2/2+2/3	Stanley Road Ahead Left	U	3	N/A	E		1	13	-	923	2066:2155	297+632	99.4 : 99.4%
3/1	A34 Left Ahead	U	4	N/A	G		1	18	-	972	2123	1008	96.4%
3/2	A34 Ahead	U	4	N/A	G		1	18	-	987	2130	1012	97.6%
3/3	A34 Ahead	U	4	N/A	G		1	18	-	980	2130	1012	96.9%
4/1+4/2	Stanley Road Left Ahead	U	1	N/A	A		1	7	-	221	1986:2105	397+421	31.5 : 22.8%
5/1	Ahead	U	5	N/A	I		1	18	-	953	2015	957	99.6%
5/2	Ahead	U	5	N/A	I		1	18	-	1061	2155	1024	103.7%
5/3	Ahead	U	5	N/A	I		1	18	-	947	2015	957	98.9%
6/1		U	N/A	N/A	-		-	-	-	832	Inf	Inf	0.0%
7/1		U	N/A	N/A	-		-	-	-	1214	Inf	Inf	0.0%
7/2		U	N/A	N/A	-		-	-	-	1251	Inf	Inf	0.0%
7/3		U	N/A	N/A	-		-	-	-	738	Inf	Inf	0.0%
8/1		U	N/A	N/A	-		-	-	-	444	Inf	Inf	0.0%
9/1	Ahead	U	1	N/A	B		1	23	-	951	2155	1293	73.5%
9/2	Ahead	U	1	N/A	B		1	23	-	1056	2155	1293	81.7%

Item	Lane Description	Lane Type	Controller Stream	Position In Filtered Route	Full Phase	Arrow Phase	Num Greens	Total Green (s)	Arrow Green (s)	Demand Flow (pcu)	Sat Flow (pcu/Hr)	Capacity (pcu)	Deg Sat (%)
9/3+9/4	Ahead Right	U	1	N/A	B		1	23	-	1317	2155:1874	1017+598	81.5 : 81.5%
10/1+10/2	Ahead Right	U	2	N/A	D		1	13	-	584	2085:1658	730+44	75.5 : 75.5%
11/1	Ahead	U	3	N/A	F		1	17	-	574	2155	970	59.2%
11/2	Ahead	U	3	N/A	F		1	17	-	956	2155	970	98.6%
11/3	Right Ahead	U	3	N/A	F		1	17	-	939	2125	956	95.9%
12/1	Ahead	U	4	N/A	H		1	12	-	353	2052	667	52.2%
12/2+12/3	Right	U	4	N/A	H		1	12	-	476	2005:2005	241+584	57.7 : 57.7%
13/1		U	N/A	N/A	-		-	-	-	953	Inf	Inf	0.0%
13/2		U	N/A	N/A	-		-	-	-	1061	Inf	Inf	0.0%
13/3		U	N/A	N/A	-		-	-	-	947	Inf	Inf	0.0%
14/1	Ahead	U	6	N/A	J		1	23	-	1214	2015	1209	100.4%
14/2	Ahead	U	6	N/A	J		1	23	-	1251	2155	1293	96.8%
14/3	Ahead	U	6	N/A	J		1	23	-	738	2015	1209	59.6%

Item	Arriving (pcu)	Leaving (pcu)	Turners In Gaps (pcu)	Turners When Unopposed (pcu)	Turners In Intergreen (pcu)	Uniform Delay (pcuHr)	Rand + Oversat Delay (pcuHr)	Storage Area Uniform Delay (pcuHr)	Total Delay (pcuHr)	Av. Delay Per PCU (s/pcu)	Max. Back of Uniform Queue (pcu)	Rand + Oversat Queue (pcu)	Mean Max Queue (pcu)
Network: A34/Stanley Road	-	-	0	0	0	37.6	200.4	0.0	238.1	-	-	-	-
Stanley Green	-	-	0	0	0	37.6	200.4	0.0	238.1	-	-	-	-
1/1	855	855	-	-	-	2.6	10.5	-	13.1	55.0	9.3	10.5	19.7
1/2+1/3	1862	1840	-	-	-	5.8	28.2	-	34.0	65.7	10.4	28.2	38.5
2/1	640	640	-	-	-	2.2	3.5	-	5.7	32.2	6.6	3.5	10.1
2/2+2/3	923	923	-	-	-	3.1	13.8	-	16.8	65.7	8.0	13.8	21.8
3/1	972	972	-	-	-	2.7	8.9	-	11.7	43.3	10.3	8.9	19.2
3/2	987	987	-	-	-	2.8	10.7	-	13.5	49.3	10.7	10.7	21.4
3/3	980	980	-	-	-	2.8	9.6	-	12.4	45.5	10.3	9.6	20.0
4/1+4/2	221	221	-	-	-	0.8	0.2	-	1.0	16.6	1.2	0.2	1.4
5/1	953	953	-	-	-	0.5	14.4	-	14.9	56.4	7.2	14.4	21.6
5/2	1061	1024	-	-	-	1.3	28.1	-	29.4	99.7	12.4	28.1	40.5
5/3	947	947	-	-	-	1.9	13.1	-	14.9	56.8	10.2	13.1	23.2
6/1	832	832	-	-	-	0.0	0.0	-	0.0	0.0	0.0	0.0	0.0
7/1	1209	1209	-	-	-	0.0	0.0	-	0.0	0.0	0.0	0.0	0.0
7/2	1251	1251	-	-	-	0.0	0.0	-	0.0	0.0	0.0	0.0	0.0
7/3	721	721	-	-	-	0.0	0.0	-	0.0	0.0	0.0	0.0	0.0
8/1	439	439	-	-	-	0.0	0.0	-	0.0	0.0	0.0	0.0	0.0
9/1	951	951	-	-	-	0.3	1.4	-	1.7	6.3	1.1	1.4	2.5
9/2	1056	1056	-	-	-	0.3	2.2	-	2.5	8.5	1.1	2.2	3.3
9/3+9/4	1317	1317	-	-	-	1.3	2.2	-	3.4	9.4	7.9	2.2	10.1

Item	Arriving (pcu)	Leaving (pcu)	Turners In Gaps (pcu)	Turners When Unopposed (pcu)	Turners In Intergreen (pcu)	Uniform Delay (pcuHr)	Rand + Oversat Delay (pcuHr)	Storage Area Uniform Delay (pcuHr)	Total Delay (pcuHr)	Av. Delay Per PCU (s/pcu)	Max. Back of Uniform Queue (pcu)	Rand + Oversat Queue (pcu)	Mean Max Queue (pcu)	
10/1+10/2	584	584	-	-	-	1.5	1.5	-	3.0	18.6	5.8	1.5	7.4	
11/1	574	574	-	-	-	0.1	0.7	-	0.8	5.1	0.3	0.7	1.1	
11/2	956	956	-	-	-	0.3	12.4	-	12.7	47.7	1.5	12.4	13.9	
11/3	917	917	-	-	-	0.4	8.3	-	8.7	34.1	3.4	8.3	11.6	
12/1	348	348	-	-	-	0.9	0.5	-	1.5	15.2	2.9	0.5	3.5	
12/2+12/3	476	476	-	-	-	0.6	0.7	-	1.3	10.0	0.7	0.7	1.4	
13/1	953	953	-	-	-	0.0	0.0	-	0.0	0.0	0.0	0.0	0.0	
13/2	1024	1024	-	-	-	0.0	0.0	-	0.0	0.0	0.0	0.0	0.0	
13/3	947	947	-	-	-	0.0	0.0	-	0.0	0.0	0.0	0.0	0.0	
14/1	1214	1209	-	-	-	3.8	18.7	-	22.5	66.8	13.5	18.7	32.3	
14/2	1251	1251	-	-	-	1.7	10.1	-	11.8	33.8	13.1	10.1	23.1	
14/3	721	721	-	-	-	0.0	0.7	-	0.7	3.7	0.0	0.7	0.7	
			C1 Stream: 1 PRC for Signalled Lanes (%)	10.2	Total Delay for Signalled Lanes (pcuHr):			8.60	Cycle Time (s):			40		
			C1 Stream: 2 PRC for Signalled Lanes (%)	-13.8	Total Delay for Signalled Lanes (pcuHr):			50.08	Cycle Time (s):			40		
			C1 Stream: 3 PRC for Signalled Lanes (%)	-10.4	Total Delay for Signalled Lanes (pcuHr):			44.74	Cycle Time (s):			40		
			C1 Stream: 4 PRC for Signalled Lanes (%)	-8.4	Total Delay for Signalled Lanes (pcuHr):			40.39	Cycle Time (s):			40		
			C1 Stream: 5 PRC for Signalled Lanes (%)	-15.2	Total Delay for Signalled Lanes (pcuHr):			59.25	Cycle Time (s):			40		
			C1 Stream: 6 PRC for Signalled Lanes (%)	-11.6	Total Delay for Signalled Lanes (pcuHr):			35.03	Cycle Time (s):			40		
			PRC Over All Lanes (%)	-15.2	Total Delay Over All Lanes (pcuHr):			238.08						

Scenario 2: 'PM 2017' (FG2: 'PM 2017', Plan 1: 'Plan1')

Stage Sequence Diagram

Stage Stream: 1

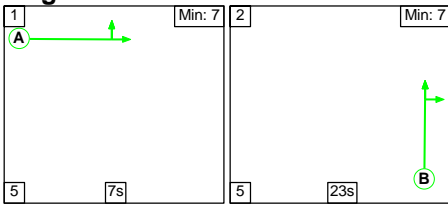

Stage Stream: 2

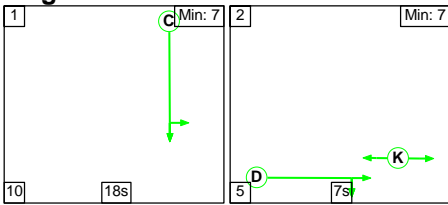

Stage Stream: 3

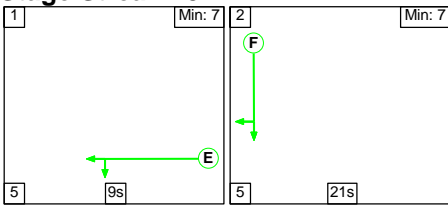

Stage Stream: 4

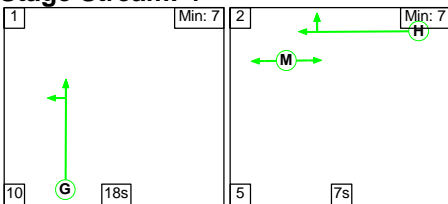

Stage Stream: 5

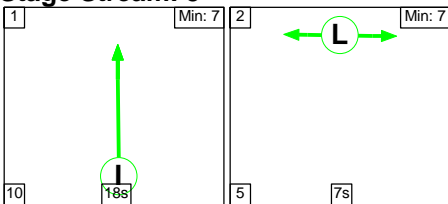

Stage Stream: 6

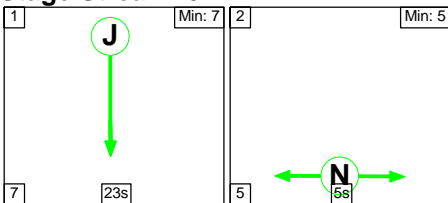

Stage Timings

Stage Stream: 1

Stage	1	2
Duration	7	23
Change Point	39	11

Stage Stream: 2

Stage	1	2
Duration	18	7
Change Point	1	29

Stage Stream: 3

Stage	1	2
Duration	9	21
Change Point	36	10

Stage Stream: 4

Stage	1	2
Duration	18	7
Change Point	7	35

Stage Stream: 5

Stage	1	2
Duration	18	7
Change Point	9	37

Stage Stream: 6

Stage	1	2
Duration	23	5
Change Point	5	35

Signal Timings Diagram

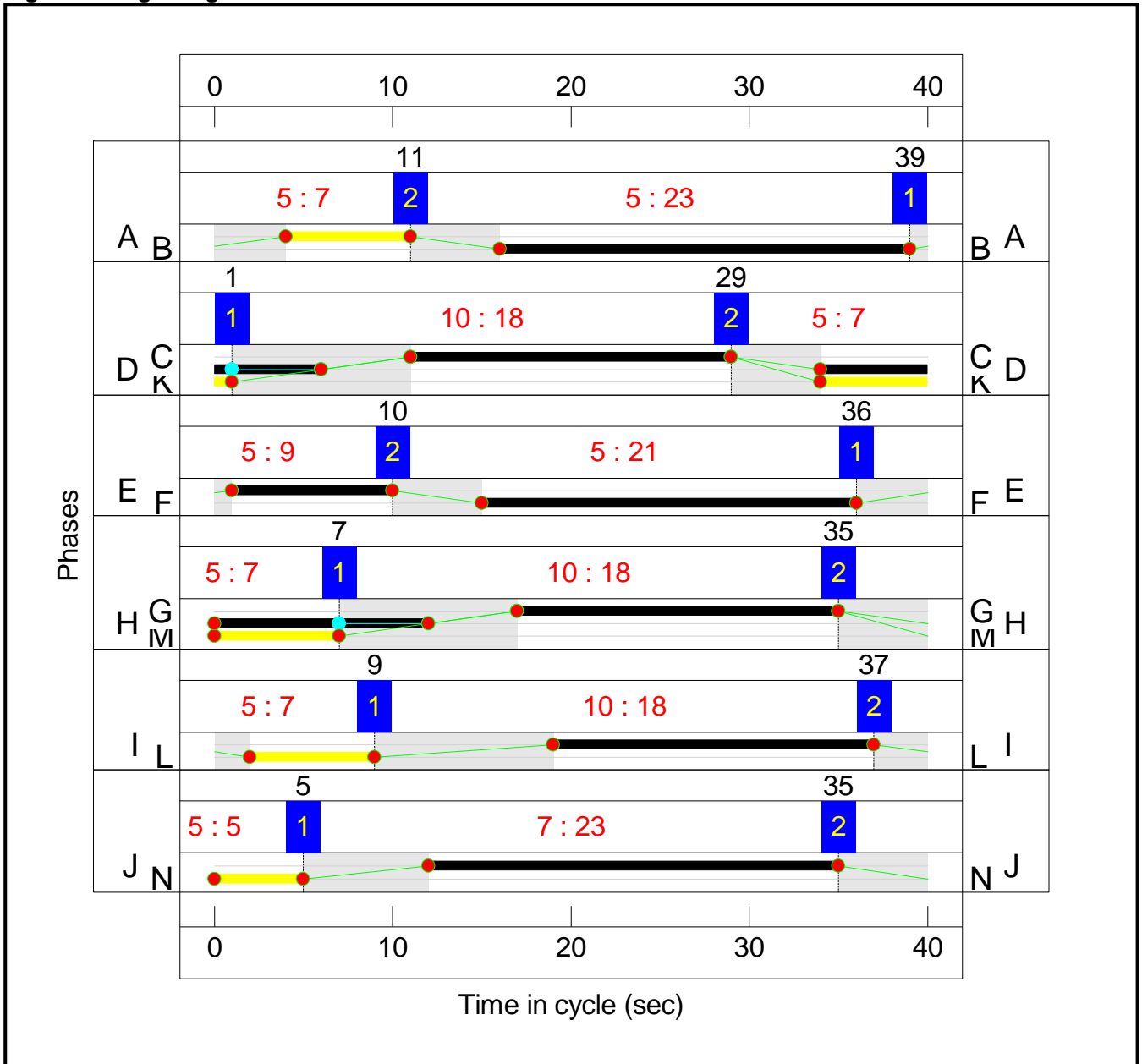

Network Layout Diagram

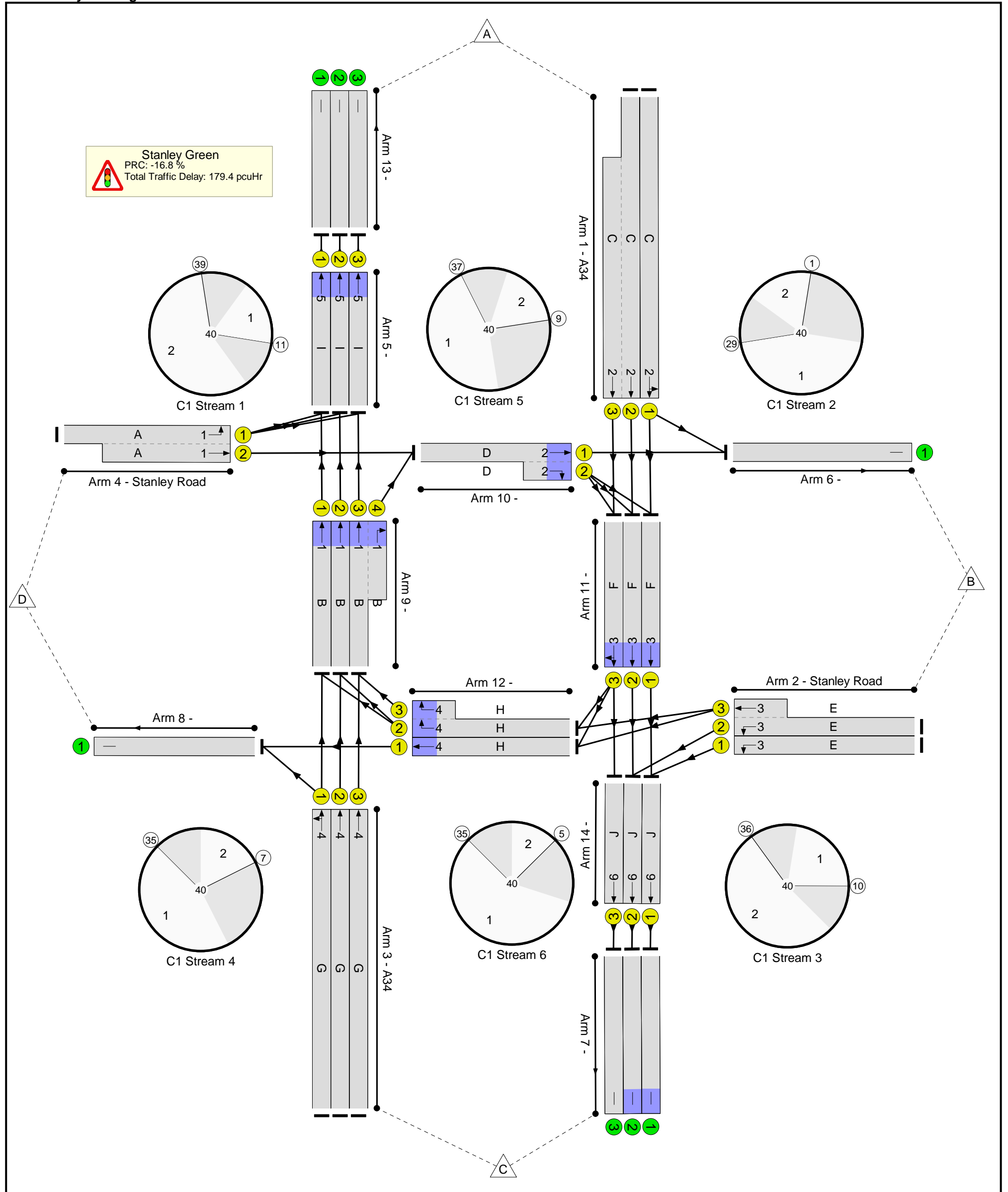

Network Results

Item	Lane Description	Lane Type	Controller Stream	Position In Filtered Route	Full Phase	Arrow Phase	Num Greens	Total Green (s)	Arrow Green (s)	Demand Flow (pcu)	Sat Flow (pcu/Hr)	Capacity (pcu)	Deg Sat (%)
Network: A34/Stanley Road	-	-	N/A	-	-		-	-	-	-	-	-	105.1%
Stanley Green	-	-	N/A	-	-		-	-	-	-	-	-	105.1%
1/1	A34 Left Ahead	U	2	N/A	C		1	18	-	908	1929	916	99.1%
1/2+1/3	A34 Ahead	U	2	N/A	C		1	18	-	1974	2130:1965	1012+933	98.1 : 105.1%
2/1	Stanley Road Left	U	3	N/A	E		1	9	-	436	2066	516	84.4%
2/2+2/3	Stanley Road Ahead Left	U	3	N/A	E		1	9	-	587	2066:2155	193+493	85.6 : 85.6%
3/1	A34 Left Ahead	U	4	N/A	G		1	18	-	948	2124	1009	94.0%
3/2	A34 Ahead	U	4	N/A	G		1	18	-	969	2130	1012	95.8%
3/3	A34 Ahead	U	4	N/A	G		1	18	-	970	2130	1012	95.9%
4/1+4/2	Stanley Road Left Ahead	U	1	N/A	A		1	7	-	463	1986:2105	397+421	53.6 : 59.4%
5/1	Ahead	U	5	N/A	I		1	18	-	933	2015	957	97.5%
5/2	Ahead	U	5	N/A	I		1	18	-	1041	2155	1024	101.7%
5/3	Ahead	U	5	N/A	I		1	18	-	933	2015	957	97.5%
6/1		U	N/A	N/A	-		-	-	-	1057	Inf	Inf	0.0%
7/1		U	N/A	N/A	-		-	-	-	940	Inf	Inf	0.0%
7/2		U	N/A	N/A	-		-	-	-	1158	Inf	Inf	0.0%
7/3		U	N/A	N/A	-		-	-	-	964	Inf	Inf	0.0%
8/1		U	N/A	N/A	-		-	-	-	229	Inf	Inf	0.0%
9/1	Ahead	U	1	N/A	B		1	23	-	928	2155	1293	71.8%
9/2	Ahead	U	1	N/A	B		1	23	-	1026	2155	1293	79.4%

Item	Lane Description	Lane Type	Controller Stream	Position In Filtered Route	Full Phase	Arrow Phase	Num Greens	Total Green (s)	Arrow Green (s)	Demand Flow (pcu)	Sat Flow (pcu/Hr)	Capacity (pcu)	Deg Sat (%)
9/3+9/4	Ahead Right	U	1	N/A	B		1	23	-	1159	2155:1874	1023+579	72.3 : 72.3%
10/1+10/2	Ahead Right	U	2	N/A	D		1	12	-	669	2085:1658	644+138	85.6 : 85.6%
11/1	Ahead	U	3	N/A	F		1	21	-	504	2155	1185	42.5%
11/2	Ahead	U	3	N/A	F		1	21	-	993	2155	1185	83.8%
11/3	Right Ahead	U	3	N/A	F		1	21	-	997	2150	1182	80.3%
12/1	Ahead	U	4	N/A	H		1	12	-	153	2052	667	22.7%
12/2+12/3	Right	U	4	N/A	H		1	12	-	302	2005:2005	331+554	34.1 : 34.1%
13/1		U	N/A	N/A	-		-	-	-	933	Inf	Inf	0.0%
13/2		U	N/A	N/A	-		-	-	-	1041	Inf	Inf	0.0%
13/3		U	N/A	N/A	-		-	-	-	933	Inf	Inf	0.0%
14/1	Ahead	U	6	N/A	J		1	23	-	940	2015	1209	77.8%
14/2	Ahead	U	6	N/A	J		1	23	-	1158	2155	1293	89.6%
14/3	Ahead	U	6	N/A	J		1	23	-	964	2015	1209	75.9%

Item	Arriving (pcu)	Leaving (pcu)	Turners In Gaps (pcu)	Turners When Unopposed (pcu)	Turners In Intergreen (pcu)	Uniform Delay (pcuHr)	Rand + Oversat Delay (pcuHr)	Storage Area Uniform Delay (pcuHr)	Total Delay (pcuHr)	Av. Delay Per PCU (s/pcu)	Max. Back of Uniform Queue (pcu)	Rand + Oversat Queue (pcu)	Mean Max Queue (pcu)
Network: A34/Stanley Road	-	-	0	0	0	35.6	143.8	0.0	179.4	-	-	-	-
Stanley Green	-	-	0	0	0	35.6	143.8	0.0	179.4	-	-	-	-
1/1	908	908	-	-	-	2.6	13.1	-	15.8	62.5	9.8	13.1	23.0
1/2+1/3	1974	1926	-	-	-	6.5	40.0	-	46.4	84.7	11.4	40.0	51.4
2/1	436	436	-	-	-	1.7	2.5	-	4.3	35.3	4.6	2.5	7.1
2/2+2/3	587	587	-	-	-	2.2	2.8	-	5.0	30.8	4.5	2.8	7.3
3/1	948	948	-	-	-	2.6	6.4	-	9.0	34.4	9.7	6.4	16.2
3/2	969	969	-	-	-	2.7	8.2	-	10.9	40.6	10.2	8.2	18.4
3/3	970	970	-	-	-	2.7	8.3	-	11.0	41.0	10.2	8.3	18.5
4/1+4/2	463	463	-	-	-	1.9	0.6	-	2.5	19.5	2.5	0.6	3.1
5/1	933	933	-	-	-	1.3	10.4	-	11.7	45.1	4.1	10.4	14.5
5/2	1041	1024	-	-	-	2.0	21.1	-	23.1	79.8	12.0	21.1	33.0
5/3	933	933	-	-	-	2.3	10.4	-	12.6	48.8	9.7	10.4	20.1
6/1	1057	1057	-	-	-	0.0	0.0	-	0.0	0.0	0.0	0.0	0.0
7/1	940	940	-	-	-	0.0	0.0	-	0.0	0.0	0.0	0.0	0.0
7/2	1158	1158	-	-	-	0.0	0.0	-	0.0	0.0	0.0	0.0	0.0
7/3	918	918	-	-	-	0.0	0.0	-	0.0	0.0	0.0	0.0	0.0
8/1	227	227	-	-	-	0.0	0.0	-	0.0	0.0	0.0	0.0	0.0
9/1	928	928	-	-	-	0.3	1.3	-	1.5	5.9	1.1	1.3	2.3
9/2	1026	1026	-	-	-	0.3	1.9	-	2.2	7.7	1.2	1.9	3.1
9/3+9/4	1159	1159	-	-	-	0.8	1.3	-	2.1	6.5	6.8	1.3	8.1

Item	Arriving (pcu)	Leaving (pcu)	Turners In Gaps (pcu)	Turners When Unopposed (pcu)	Turners In Intergreen (pcu)	Uniform Delay (pcuHr)	Rand + Oversat Delay (pcuHr)	Storage Area Uniform Delay (pcuHr)	Total Delay (pcuHr)	Av. Delay Per PCU (s/pcu)	Max. Back of Uniform Queue (pcu)	Rand + Oversat Queue (pcu)	Mean Max Queue (pcu)	
10/1+10/2	669	669	-	-	-	2.8	2.8	-	5.6	30.1	6.1	2.8	9.0	
11/1	504	504	-	-	-	0.5	0.4	-	0.9	6.2	1.9	0.4	2.2	
11/2	993	993	-	-	-	0.0	2.5	-	2.5	9.2	0.3	2.5	2.8	
11/3	949	949	-	-	-	0.1	2.0	-	2.1	8.0	0.5	2.0	2.5	
12/1	151	151	-	-	-	0.1	0.1	-	0.3	6.8	0.4	0.1	0.5	
12/2+12/3	302	302	-	-	-	0.1	0.3	-	0.3	4.1	0.1	0.3	0.3	
13/1	933	933	-	-	-	0.0	0.0	-	0.0	0.0	0.0	0.0	0.0	
13/2	1024	1024	-	-	-	0.0	0.0	-	0.0	0.0	0.0	0.0	0.0	
13/3	933	933	-	-	-	0.0	0.0	-	0.0	0.0	0.0	0.0	0.0	
14/1	940	940	-	-	-	1.4	1.7	-	3.1	11.8	8.4	1.7	10.1	
14/2	1158	1158	-	-	-	0.6	4.0	-	4.6	14.3	2.3	4.0	6.4	
14/3	918	918	-	-	-	0.2	1.6	-	1.8	6.9	0.6	1.6	2.1	
			C1 Stream: 1 PRC for Signalled Lanes (%)	13.4	Total Delay for Signalled Lanes (pcuHr):			8.31	Cycle Time (s):			40		
			C1 Stream: 2 PRC for Signalled Lanes (%)	-16.8	Total Delay for Signalled Lanes (pcuHr):			67.79	Cycle Time (s):			40		
			C1 Stream: 3 PRC for Signalled Lanes (%)	5.1	Total Delay for Signalled Lanes (pcuHr):			14.82	Cycle Time (s):			40		
			C1 Stream: 4 PRC for Signalled Lanes (%)	-6.5	Total Delay for Signalled Lanes (pcuHr):			31.63	Cycle Time (s):			40		
			C1 Stream: 5 PRC for Signalled Lanes (%)	-13.0	Total Delay for Signalled Lanes (pcuHr):			47.41	Cycle Time (s):			40		
			C1 Stream: 6 PRC for Signalled Lanes (%)	0.5	Total Delay for Signalled Lanes (pcuHr):			9.46	Cycle Time (s):			40		
			PRC Over All Lanes (%)	-16.8	Total Delay Over All Lanes (pcuHr):			179.41						

Appendix F.8

A6MARR/ B5358 Wilmslow Road ARCADY Output

A6MARR/ B5358 Wilmslow Road ARCADY Output

Junctions 8
ARCADY 8 - Roundabout Module
Version: 8.0.2.316 [14 Feb 2013] © Copyright TRL Limited, 2013
For sales and distribution information, program advice and maintenance, contact TRL: Tel: +44 (0)1344 770758 E-mail: software@trl.co.uk Web: http://www.trlsoftware.co.uk
The users of this computer program for the solution of an engineering problem are in no way relieved of their responsibility for the correctness of the solution

Filename: HFAS Northern Roundabout v2.arc8

Summary of junction performance

	2017 AM				2017 PM			
	Queue (PCU)	Delay (s)	RFC	LOS	Queue (PCU)	Delay (s)	RFC	LOS
Design Test Layout 1 - Scenario 1								
Arm A	0.88	4.22	0.47	A	1.21	4.88	0.55	A
Arm C	2.38	7.87	0.71	A	1.67	6.19	0.63	A
Arm D	0.96	6.34	0.49	A	0.75	5.24	0.43	A

Values shown are the maximum values over all time segments. Delay is the maximum value of average delay per arriving vehicle.

"D1 - Scenario 1, 2017 AM" model duration: 07:45 - 09:15
 "D2 - Scenario 1, 2017 PM" model duration: 16:45 - 18:15
 "D3 - Scenario 1, 2032 AM" model duration: 07:45 - 09:15
 "D4 - Scenario 1, 2032 PM" model duration: 16:45 - 18:15

Run using Junctions 8.0.2.316 at 02/10/2013 17:37:13

File summary

File Description

Title	Wilmslow Road Roundabouts HFAS
Location	Northern Roundabout - SEMMMS
Site Number	
Date	23/01/2013
Version	
Status	(new file)
Identifier	
Client	
Jobnumber	
Enumerator	GMPTE\atkinsonm
Description	

Analysis Options

Vehicle Length (m)	Do Queue Variations	Calculate Residual Capacity	Residual Capacity Criteria Type	RFC Threshold	Average Delay Threshold (s)	Queue Threshold (PCU)
5.75			N/A	0.85	36.00	20.00

Units

Distance Units	Speed Units	Traffic Units Input	Traffic Units Results	Flow Units	Average Delay Units	Total Delay Units	Rate Of Delay Units
m	kph	PCU	PCU	perHour	s	-Min	perMin

Design Test Layout 1 - Scenario 1, 2017 AM

Data Errors and Warnings

Severity	Area	Item	Description
Warning	Geometry	Arm D - Roundabout Geometry	Effective flare length is over 30m, which is outside the normal range. Treat capacities with increasing caution.
Warning	Pedestrian Crossing	Arm A - Pelican/Puffin Details	Pedestrian crossing uses default flow of 0. Is this correct?
Warning	DemandSets	D1 - Scenario 1, 2017 AM	Time results are shown for central hour only. (Model is run for a 90 minute period.)

Analysis Set Details

Name	Roundabout Capacity Model	Description	Include In Report	Use Specific Demand Set(s)	Specific Demand Set(s)	Locked	Network Flow Scaling Factor (%)	Network Capacity Scaling Factor (%)	Reason For Scaling Factors
Design Test Layout 1	ARCADY		✓	✓	D1,D2		100.000	100.000	

Demand Set Details

Name	Scenario Name	Time Period Name	Description	Traffic Profile Type	Model Start Time (HH:mm)	Model Finish Time (HH:mm)	Model Time Period Length (min)	Time Segment Length (min)	Results For Central Hour Only	Single Time Segment Only	Locked	Run Automatically	Use Relationship	Relationship
Scenario 1, 2017 AM	Scenario 1	2017 AM		ONE HOUR	07:45	09:15	90	15	✓			✓		

Junction Network

Junctions

Name	Junction Type	Arm Order	Grade Separated	Large Roundabout	Do Geometric Delay	Junction Delay (s)	Junction LOS
Nothern Roundabout	Roundabout	A,B,C,D				6.37	A

Junction Network Options

Driving Side	Lighting
Left	Normal/unknown

Arms

Arms

Arm	Name	Description
A	Northern Arm	
B	Eastern On-Slip	Exit Only
C	Southern Arm	Link to Southern RB
D	Western Off-Slip	

Capacity Options

Arm	Minimum Capacity (PCU/hr)	Maximum Capacity (PCU/hr)	Assume Flat Start Profile	Initial Queue (PCU)
A	0.00	99999.00		0.00
B	0.00	99999.00		0.00
C	0.00	99999.00		0.00
D	0.00	99999.00		0.00

Roundabout Geometry

Arm	V - Approach road half-width (m)	E - Entry width (m)	I' - Effective flare length (m)	R - Entry radius (m)	D - Inscribed circle diameter (m)	PHI - Conflict (entry) angle (deg)	Exit Only
A	4.40	7.70	17.20	26.10	40.10	16.80	
B	Exit-only	Exit-only	Exit-only	Exit-only	Exit-only	Exit-only	✓
C	3.70	6.00	9.50	33.70	40.10	27.10	
D	3.90	6.30	32.60	20.00	40.10	10.50	

Geometries for Arm C are measured opposite Arm B. Geometries for Arm A (if relevant) are measured opposite Arm D.

Pedestrian Crossings

Arm	Crossing Type
A	Pelican
B	None
C	None
D	None

Pelican/ Puffin Crossings

Arm	Amber time preceding red (s)	Amber time regarded as green (s)	Time from traffic red start to green man start (s)	Time period green man shown (s)	Clearance Period (s)	Traffic minimum green (s)	Space between crossing and junction entry (PCU)
A	3.00	2.00	2.00	4.00	7.00	74.00	5.00

Slope / Intercept / Capacity

Roundabout Slope and Intercept used in model

Arm	Enter slope and intercept directly	Entered slope	Entered intercept (PCU/hr)	Final Slope	Final Intercept (PCU/hr)
A		(calculated)	(calculated)	0.732	2064.495
B		(calculated)	(calculated)	Exit-only	Exit-only
C		(calculated)	(calculated)	0.623	1559.104
D		(calculated)	(calculated)	0.700	1890.032

The slope and intercept shown above include any corrections and adjustments.

Traffic Flows

Demand Set Data Options

Default Vehicle Mix	Vehicle Mix Varies Over Time	Vehicle Mix Varies Over Turn	Vehicle Mix Varies Over Entry	Vehicle Mix Source	PCU Factor for a HV (PCU)	Default Turning Proportions	Estimate from entry/exit counts	Turning Proportions Vary Over Time	Turning Proportions Vary Over Turn	Turning Proportions Vary Over Entry
		✓	✓	HV Percentages	2.00				✓	✓

Entry Flows

General Flows Data

Arm	Profile Type	Use Turning Counts	Average Demand Flow (PCU/hr)	Flow Scaling Factor (%)
A	ONE HOUR	✓	687.00	100.000
B	Exit-only	✓	Exit-only	Exit-only
C	ONE HOUR	✓	1001.00	100.000
D	ONE HOUR	✓	500.00	100.000

Pedestrian Flows

General Flows Data

Arm	Profile Type	Average Pedestrian Flow (Ped/hr)
A	ONE HOUR	0.00
B	-	-
C	-	-
D	-	-

Turning Proportions

Turning Counts or Proportions (PCU/hr) - Junction 1 (for whole period)

		To			
		A	B	C	D
From	A	0.000	202.000	485.000	0.000
	B	Exit-only	Exit-only	Exit-only	Exit-only
	C	842.000	159.000	0.000	0.000
	D	94.000	0.000	406.000	0.000

Arm B is exit only and so the above grid should be ignored for this Arm.

Turning Proportions (PCU) - Junction 1 (for whole period)

		To			
		A	B	C	D
From	A	0.00	0.29	0.71	0.00
	B	0.25	0.25	0.25	0.25
	C	0.84	0.16	0.00	0.00
	D	0.19	0.00	0.81	0.00

Arm B is exit only and so the above grid should be ignored for this Arm.

Vehicle Mix

Average PCU Per Vehicle - Junction 1 (for whole period)

		To			
		A	B	C	D
From	A	1.000	1.000	1.000	1.000
	B	Exit-only	Exit-only	Exit-only	Exit-only
	C	1.000	1.000	1.000	1.000
	D	1.000	1.000	1.000	1.000

Arm B is exit only and so the above grid should be ignored for this Arm.

Heavy Vehicle Percentages - Junction 1 (for whole period)

		To			
		A	B	C	D
From	A	0.000	0.000	0.000	0.000
	B	Exit-only	Exit-only	Exit-only	Exit-only
	C	0.000	0.000	0.000	0.000
	D	0.000	0.000	0.000	0.000

Arm B is exit only and so the above grid should be ignored for this Arm.

Results

Results Summary for whole modelled period

Arm	Max RFC	Max Delay (s)	Max Queue (PCU)	Max LOS	Average Demand (PCU/hr)	Total Junction Arrivals (PCU)	Total Queueing Delay (PCU-min)	Average Queueing Delay (s)	Rate Of Queueing Delay (PCU-min/min)	Inclusive Total Queueing Delay (PCU-min)	Inclusive Average Queueing Delay (s)
A	0.47	4.22	0.88	A	687.00	687.00	43.33	3.78	0.48	55.86	3.54
B	Exit-only	Exit-only	Exit-only	Exit-only	Exit-only	Exit-only	Exit-only	Exit-only	Exit-only	Exit-only	Exit-only
C	0.71	7.87	2.38	A	1001.00	1001.00	109.88	6.59	1.22	137.89	6.00
D	0.49	6.34	0.96	A	500.00	500.00	44.86	5.38	0.50	56.28	4.91

Main Results for each time segment

Main results: (08:00-08:15)

Arm	Total Demand (PCU/hr)	Junction Arrivals (PCU)	Entry Flow (PCU/hr)	Exit Flow (PCU/hr)	Circulating Flow (PCU/hr)	Pedestrian Demand (Ped/hr)	Capacity (PCU/hr)	Saturation Capacity (PCU/hr)	RFC	Start Queue (PCU)	End Queue (PCU)	Delay (s)	LOS
A	617.60	154.40	616.98	839.90	507.10	0.00	1693.44	1400.54	0.365	0.42	0.57	3.342	A
B	Exit-only	Exit-only	Exit-only	324.08	Exit-only	0.00	Exit-only	Exit-only	Exit-only	Exit-only	Exit-only	Exit-only	Exit-only
C	899.88	224.97	898.20	800.00	0.00	0.00	1559.10	1525.50	0.577	0.93	1.35	5.432	A
D	449.49	112.37	448.81	0.00	898.20	0.00	1261.24	796.90	0.356	0.38	0.55	4.427	A

Main results: (08:15-08:30)

Arm	Total Demand (PCU/hr)	Junction Arrivals (PCU)	Entry Flow (PCU/hr)	Exit Flow (PCU/hr)	Circulating Flow (PCU/hr)	Pedestrian Demand (Ped/hr)	Capacity (PCU/hr)	Saturation Capacity (PCU/hr)	RFC	Start Queue (PCU)	End Queue (PCU)	Delay (s)	LOS
A	756.40	189.10	755.17	1026.89	620.14	0.00	1610.73	1400.54	0.470	0.57	0.88	4.201	A
B	Exit-only	Exit-only	Exit-only	396.47	Exit-only	0.00	Exit-only	Exit-only	Exit-only	Exit-only	Exit-only	Exit-only	Exit-only
C	1102.12	275.53	1098.13	978.84	0.00	0.00	1559.10	1525.50	0.707	1.35	2.34	7.742	A
D	550.51	137.63	548.90	0.00	1098.13	0.00	1121.28	796.90	0.491	0.55	0.95	6.272	A

Main results: (08:30-08:45)

Arm	Total Demand (PCU/hr)	Junction Arrivals (PCU)	Entry Flow (PCU/hr)	Exit Flow (PCU/hr)	Circulating Flow (PCU/hr)	Pedestrian Demand (Ped/hr)	Capacity (PCU/hr)	Saturation Capacity (PCU/hr)	RFC	Start Queue (PCU)	End Queue (PCU)	Delay (s)	LOS
A	756.40	189.10	756.38	1030.44	622.02	0.00	1609.35	1400.54	0.470	0.88	0.88	4.220	A
B	Exit-only	Exit-only	Exit-only	397.44	Exit-only	0.00	Exit-only	Exit-only	Exit-only	Exit-only	Exit-only	Exit-only	Exit-only
C	1102.12	275.53	1101.99	980.96	0.00	0.00	1559.10	1525.50	0.707	2.34	2.38	7.869	A
D	550.51	137.63	550.47	0.00	1101.99	0.00	1118.57	796.90	0.492	0.95	0.96	6.336	A

Main results: (08:45-09:00)

Arm	Total Demand (PCU/hr)	Junction Arrivals (PCU)	Entry Flow (PCU/hr)	Exit Flow (PCU/hr)	Circulating Flow (PCU/hr)	Pedestrian Demand (Ped/hr)	Capacity (PCU/hr)	Saturation Capacity (PCU/hr)	RFC	Start Queue (PCU)	End Queue (PCU)	Delay (s)	LOS
A	617.60	154.40	618.82	845.09	509.86	0.00	1691.42	1400.54	0.365	0.88	0.58	3.361	A
B	Exit-only	Exit-only	Exit-only	325.52	Exit-only	0.00	Exit-only	Exit-only	Exit-only	Exit-only	Exit-only	Exit-only	Exit-only
C	899.88	224.97	903.85	803.15	0.00	0.00	1559.10	1525.50	0.577	2.38	1.38	5.526	A
D	449.49	112.37	451.09	0.00	903.85	0.00	1257.28	796.90	0.358	0.96	0.56	4.473	A

Queueing Delay Results for each time segment

Queueing Delay results: (08:00-08:15)

Arm	Queueing Total Delay (PCU-min)	Queueing Rate Of Delay (PCU-min/min)	Average Delay Per Arriving Vehicle (s)	Unsignalised Level Of Service	Signalised Level Of Service
A	8.42	0.56	3.342	A	A
B	Exit-only	Exit-only	Exit-only	Exit-only	Exit-only
C	19.56	1.30	5.432	A	A
D	8.07	0.54	4.427	A	A

Queueing Delay results: (08:15-08:30)

Arm	Queueing Total Delay (PCU-min)	Queueing Rate Of Delay (PCU-min/min)	Average Delay Per Arriving Vehicle (s)	Unsignalised Level Of Service	Signalised Level Of Service
A	12.85	0.86	4.201	A	A
B	Exit-only	Exit-only	Exit-only	Exit-only	Exit-only
C	33.26	2.22	7.742	A	A
D	13.78	0.92	6.272	A	A

Queueing Delay results: (08:30-08:45)

Arm	Queueing Total Delay (PCU-min)	Queueing Rate Of Delay (PCU-min/min)	Average Delay Per Arriving Vehicle (s)	Unsignalised Level Of Service	Signalised Level Of Service
A	13.21	0.88	4.220	A	A
B	Exit-only	Exit-only	Exit-only	Exit-only	Exit-only
C	35.47	2.36	7.869	A	A
D	14.37	0.96	6.336	A	A

Queueing Delay results: (08:45-09:00)

Arm	Queueing Total Delay (PCU-min)	Queueing Rate Of Delay (PCU-min/min)	Average Delay Per Arriving Vehicle (s)	Unsignalised Level Of Service	Signalised Level Of Service
A	8.85	0.59	3.361	A	A
B	Exit-only	Exit-only	Exit-only	Exit-only	Exit-only
C	21.60	1.44	5.526	A	A
D	8.63	0.58	4.473	A	A

Design Test Layout 1 - Scenario 1, 2017 PM

Data Errors and Warnings

Severity	Area	Item	Description
Warning	Geometry	Arm D - Roundabout Geometry	Effective flare length is over 30m, which is outside the normal range. Treat capacities with increasing caution.
Warning	Pedestrian Crossing	Arm A - Pelican/Puffin Details	Pedestrian crossing uses default flow of 0. Is this correct?
Warning	DemandSets	D2 - Scenario 1, 2017 PM	Time results are shown for central hour only. (Model is run for a 90 minute period.)

Analysis Set Details

Name	Roundabout Capacity Model	Description	Include In Report	Use Specific Demand Set(s)	Specific Demand Set(s)	Locked	Network Flow Scaling Factor (%)	Network Capacity Scaling Factor (%)	Reason For Scaling Factors
Design Test Layout 1	ARCADY		✓	✓	D1,D2		100.000	100.000	

Demand Set Details

Name	Scenario Name	Time Period Name	Description	Traffic Profile Type	Model Start Time (HH:mm)	Model Finish Time (HH:mm)	Model Time Period Length (min)	Time Segment Length (min)	Results For Central Hour Only	Single Time Segment Only	Locked	Run Automatically	Use Relationship	Relationship
Scenario 1, 2017 PM	Scenario 1	2017 PM		ONE HOUR	16:45	18:15	90	15	✓			✓		

Junction Network

Junctions

Name	Junction Type	Arm Order	Grade Separated	Large Roundabout	Do Geometric Delay	Junction Delay (s)	Junction LOS
Nothern Roundabout	Roundabout	A,B,C,D				5.49	A

Junction Network Options

Driving Side	Lighting
Left	Normal/unknown

Arms

Arms

Arm	Name	Description
A	Northern Arm	
B	Eastern On-Slip	Exit Only
C	Southern Arm	Link to Southern RB
D	Western Off-Slip	

Capacity Options

Arm	Minimum Capacity (PCU/hr)	Maximum Capacity (PCU/hr)	Assume Flat Start Profile	Initial Queue (PCU)
A	0.00	99999.00		0.00
B	0.00	99999.00		0.00
C	0.00	99999.00		0.00
D	0.00	99999.00		0.00

Roundabout Geometry

Arm	V - Approach road half-width (m)	E - Entry width (m)	I' - Effective flare length (m)	R - Entry radius (m)	D - Inscribed circle diameter (m)	PHI - Conflict (entry) angle (deg)	Exit Only
A	4.40	7.70	17.20	26.10	40.10	16.80	
B	Exit-only	Exit-only	Exit-only	Exit-only	Exit-only	Exit-only	✓
C	3.70	6.00	9.50	33.70	40.10	27.10	
D	3.90	6.30	32.60	20.00	40.10	10.50	

Geometries for Arm C are measured opposite Arm B. Geometries for Arm A (if relevant) are measured opposite Arm D.

Pedestrian Crossings

Arm	Crossing Type
A	Pelican
B	None
C	None
D	None

Pelican/ Puffin Crossings

Arm	Amber time preceding red (s)	Amber time regarded as green (s)	Time from traffic red start to green man start (s)	Time period green man shown (s)	Clearance Period (s)	Traffic minimum green (s)	Space between crossing and junction entry (PCU)
A	3.00	2.00	2.00	4.00	7.00	74.00	5.00

Slope / Intercept / Capacity

Roundabout Slope and Intercept used in model

Arm	Enter slope and intercept directly	Entered slope	Entered intercept (PCU/hr)	Final Slope	Final Intercept (PCU/hr)
A		(calculated)	(calculated)	0.732	2064.495
B		(calculated)	(calculated)	Exit-only	Exit-only
C		(calculated)	(calculated)	0.623	1559.104
D		(calculated)	(calculated)	0.700	1890.032

The slope and intercept shown above include any corrections and adjustments.

Traffic Flows

Demand Set Data Options

Default Vehicle Mix	Vehicle Mix Varies Over Time	Vehicle Mix Varies Over Turn	Vehicle Mix Varies Over Entry	Vehicle Mix Source	PCU Factor for a HV (PCU)	Default Turning Proportions	Estimate from entry/exit counts	Turning Proportions Vary Over Time	Turning Proportions Vary Over Turn	Turning Proportions Vary Over Entry
		✓	✓	HV Percentages	2.00				✓	✓

Entry Flows

General Flows Data

Arm	Profile Type	Use Turning Counts	Average Demand Flow (PCU/hr)	Flow Scaling Factor (%)
A	ONE HOUR	✓	815.00	100.000
B	Exit-only	✓	Exit-only	Exit-only
C	ONE HOUR	✓	888.00	100.000
D	ONE HOUR	✓	471.00	100.000

Pedestrian Flows

General Flows Data

Arm	Profile Type	Average Pedestrian Flow (Ped/hr)
A	ONE HOUR	0.00
B	-	-
C	-	-
D	-	-

Turning Proportions

Turning Counts or Proportions (PCU/hr) - Junction 1 (for whole period)

		To			
		A	B	C	D
From	A	0.000	301.000	514.000	0.000
	B	Exit-only	Exit-only	Exit-only	Exit-only
	C	716.000	172.000	0.000	0.000
	D	110.000	0.000	361.000	0.000

Arm B is exit only and so the above grid should be ignored for this Arm.

Turning Proportions (PCU) - Junction 1 (for whole period)

		To			
		A	B	C	D
From	A	0.00	0.37	0.63	0.00
	B	0.25	0.25	0.25	0.25
	C	0.81	0.19	0.00	0.00
	D	0.23	0.00	0.77	0.00

Arm B is exit only and so the above grid should be ignored for this Arm.

Vehicle Mix

Average PCU Per Vehicle - Junction 1 (for whole period)

		To			
		A	B	C	D
From	A	1.000	1.000	1.000	1.000
	B	Exit-only	Exit-only	Exit-only	Exit-only
	C	1.000	1.000	1.000	1.000
	D	1.000	1.000	1.000	1.000

Arm B is exit only and so the above grid should be ignored for this Arm.

Heavy Vehicle Percentages - Junction 1 (for whole period)

		To			
		A	B	C	D
From	A	0.000	0.000	0.000	0.000
	B	Exit-only	Exit-only	Exit-only	Exit-only
	C	0.000	0.000	0.000	0.000
	D	0.000	0.000	0.000	0.000

Arm B is exit only and so the above grid should be ignored for this Arm.

Results

Results Summary for whole modelled period

Arm	Max RFC	Max Delay (s)	Max Queue (PCU)	Max LOS	Average Demand (PCU/hr)	Total Junction Arrivals (PCU)	Total Queueing Delay (PCU-min)	Average Queueing Delay (s)	Rate Of Queueing Delay (PCU-min/min)	Inclusive Total Queueing Delay (PCU-min)	Inclusive Average Queueing Delay (s)
A	0.55	4.88	1.21	A	815.00	815.00	58.01	4.27	0.64	73.88	3.95
B	Exit-only	Exit-only	Exit-only	Exit-only	Exit-only	Exit-only	Exit-only	Exit-only	Exit-only	Exit-only	Exit-only
C	0.63	6.19	1.67	A	888.00	888.00	80.31	5.43	0.89	102.78	5.05
D	0.43	5.24	0.75	A	471.00	471.00	36.14	4.60	0.40	46.08	4.27

Main Results for each time segment

Main results: (17:00-17:15)

Arm	Total Demand (PCU/hr)	Junction Arrivals (PCU)	Entry Flow (PCU/hr)	Exit Flow (PCU/hr)	Circulating Flow (PCU/hr)	Pedestrian Demand (Ped/hr)	Capacity (PCU/hr)	Saturation Capacity (PCU/hr)	RFC	Start Queue (PCU)	End Queue (PCU)	Delay (s)	LOS
A	732.67	183.17	731.81	741.49	478.52	0.00	1714.35	1381.52	0.427	0.53	0.74	3.660	A
B	Exit-only	Exit-only	Exit-only	424.67	Exit-only	0.00	Exit-only	Exit-only	Exit-only	Exit-only	Exit-only	Exit-only	Exit-only
C	798.29	199.57	797.12	785.66	0.00	0.00	1559.10	1495.45	0.512	0.74	1.04	4.724	A
D	423.42	105.85	422.89	0.00	797.12	0.00	1332.00	795.41	0.318	0.33	0.46	3.957	A

Main results: (17:15-17:30)

Arm	Total Demand (PCU/hr)	Junction Arrivals (PCU)	Entry Flow (PCU/hr)	Exit Flow (PCU/hr)	Circulating Flow (PCU/hr)	Pedestrian Demand (Ped/hr)	Capacity (PCU/hr)	Saturation Capacity (PCU/hr)	RFC	Start Queue (PCU)	End Queue (PCU)	Delay (s)	LOS
A	897.33	224.33	895.49	907.20	585.50	0.00	1636.07	1381.52	0.548	0.74	1.20	4.849	A
B	Exit-only	Exit-only	Exit-only	519.63	Exit-only	0.00	Exit-only	Exit-only	Exit-only	Exit-only	Exit-only	Exit-only	Exit-only
C	977.71	244.43	975.25	961.37	0.00	0.00	1559.10	1495.45	0.627	1.04	1.65	6.140	A
D	518.58	129.65	517.45	0.00	975.25	0.00	1207.30	795.41	0.430	0.46	0.75	5.210	A

Main results: (17:30-17:45)

Arm	Total Demand (PCU/hr)	Junction Arrivals (PCU)	Entry Flow (PCU/hr)	Exit Flow (PCU/hr)	Circulating Flow (PCU/hr)	Pedestrian Demand (Ped/hr)	Capacity (PCU/hr)	Saturation Capacity (PCU/hr)	RFC	Start Queue (PCU)	End Queue (PCU)	Delay (s)	LOS
A	897.33	224.33	897.30	909.39	586.82	0.00	1635.11	1381.52	0.549	1.20	1.21	4.879	A
B	Exit-only	Exit-only	Exit-only	520.76	Exit-only	0.00	Exit-only	Exit-only	Exit-only	Exit-only	Exit-only	Exit-only	Exit-only
C	977.71	244.43	977.65	963.36	0.00	0.00	1559.10	1495.45	0.627	1.65	1.67	6.188	A
D	518.58	129.65	518.56	0.00	977.65	0.00	1205.62	795.41	0.430	0.75	0.75	5.239	A

Main results: (17:45-18:00)

Arm	Total Demand (PCU/hr)	Junction Arrivals (PCU)	Entry Flow (PCU/hr)	Exit Flow (PCU/hr)	Circulating Flow (PCU/hr)	Pedestrian Demand (Ped/hr)	Capacity (PCU/hr)	Saturation Capacity (PCU/hr)	RFC	Start Queue (PCU)	End Queue (PCU)	Delay (s)	LOS
A	732.67	183.17	734.49	744.77	480.49	0.00	1712.91	1381.52	0.428	1.21	0.75	3.688	A
B	Exit-only	Exit-only	Exit-only	426.36	Exit-only	0.00	Exit-only	Exit-only	Exit-only	Exit-only	Exit-only	Exit-only	Exit-only
C	798.29	199.57	800.72	788.62	0.00	0.00	1559.10	1495.45	0.512	1.67	1.06	4.763	A
D	423.42	105.85	424.54	0.00	800.72	0.00	1329.48	795.41	0.318	0.75	0.47	3.984	A

Queueing Delay Results for each time segment

Queueing Delay results: (17:00-17:15)

Arm	Queueing Total Delay (PCU-min)	Queueing Rate Of Delay (PCU-min/min)	Average Delay Per Arriving Vehicle (s)	Unsignalised Level Of Service	Signalised Level Of Service
A	10.90	0.73	3.660	A	A
B	Exit-only	Exit-only	Exit-only	Exit-only	Exit-only
C	15.18	1.01	4.724	A	A
D	6.82	0.45	3.957	A	A

Queueing Delay results: (17:15-17:30)

Arm	Queueing Total Delay (PCU-min)	Queueing Rate Of Delay (PCU-min/min)	Average Delay Per Arriving Vehicle (s)	Unsignalised Level Of Service	Signalised Level Of Service
A	17.46	1.16	4.849	A	A
B	Exit-only	Exit-only	Exit-only	Exit-only	Exit-only
C	23.81	1.59	6.140	A	A
D	10.88	0.73	5.210	A	A

Queueing Delay results: (17:30-17:45)

Arm	Queueing Total Delay (PCU-min)	Queueing Rate Of Delay (PCU-min/min)	Average Delay Per Arriving Vehicle (s)	Unsignalised Level Of Service	Signalised Level Of Service
A	18.08	1.21	4.879	A	A
B	Exit-only	Exit-only	Exit-only	Exit-only	Exit-only
C	24.91	1.66	6.188	A	A
D	11.23	0.75	5.239	A	A

Queueing Delay results: (17:45-18:00)

Arm	Queueing Total Delay (PCU-min)	Queueing Rate Of Delay (PCU-min/min)	Average Delay Per Arriving Vehicle (s)	Unsignalised Level Of Service	Signalised Level Of Service
A	11.56	0.77	3.688	A	A
B	Exit-only	Exit-only	Exit-only	Exit-only	Exit-only
C	16.41	1.09	4.763	A	A
D	7.21	0.48	3.984	A	A

Junctions 8
ARCADY 8 - Roundabout Module
Version: 8.0.2.316 [14 Feb 2013] © Copyright TRL Limited, 2013
For sales and distribution information, program advice and maintenance, contact TRL: Tel: +44 (0)1344 770758 E-mail: software@trl.co.uk Web: http://www.trlsoftware.co.uk
The users of this computer program for the solution of an engineering problem are in no way relieved of their responsibility for the correctness of the solution

Filename: HFAS Southern Roundabout.arc8

Summary of junction performance

	2017 AM				2017 PM			
	Queue (PCU)	Delay (s)	RFC	LOS	Queue (PCU)	Delay (s)	RFC	LOS
Design Test Layout 1 - Scenario 1								
Arm A	4.56	17.16	0.82	C	4.25	16.10	0.81	C
Arm B	0.81	3.17	0.45	A	0.33	2.30	0.25	A
Arm C	2.06	9.75	0.67	A	2.86	11.91	0.74	B
Arm D	0.08	5.15	0.07	A	0.03	4.50	0.03	A

Values shown are the maximum values over all time segments. Delay is the maximum value of average delay per arriving vehicle.

"D1 - Scenario 1, 2017 AM" model duration: 07:45 - 09:15
 "D2 - Scenario 1, 2017 PM" model duration: 16:45 - 18:15
 "D3 - Scenario 1, 2032 AM" model duration: 07:45 - 09:15
 "D4 - Scenario 1, 2032 PM" model duration: 16:45 - 18:15

Run using Junctions 8.0.2.316 at 02/10/2013 17:41:42

File summary

File Description

Title	Wilmslow Road Roundabouts HFAS
Location	Southern Roundabout - SEMMMS
Site Number	
Date	23/01/2013
Version	
Status	(new file)
Identifier	
Client	
Jobnumber	
Enumerator	GMPTE\atkinsonm
Description	

Analysis Options

Vehicle Length (m)	Do Queue Variations	Calculate Residual Capacity	Residual Capacity Criteria Type	RFC Threshold	Average Delay Threshold (s)	Queue Threshold (PCU)
5.75			N/A	0.85	36.00	20.00

Units

Distance Units	Speed Units	Traffic Units Input	Traffic Units Results	Flow Units	Average Delay Units	Total Delay Units	Rate Of Delay Units
m	kph	PCU	PCU	perHour	s	-Min	perMin

Design Test Layout 1 - Scenario 1, 2017 AM

Data Errors and Warnings

No errors or warnings

Analysis Set Details

Name	Roundabout Capacity Model	Description	Include In Report	Use Specific Demand Set(s)	Specific Demand Set(s)	Locked	Network Flow Scaling Factor (%)	Network Capacity Scaling Factor (%)	Reason For Scaling Factors
Design Test Layout 1	ARCADY		✓	✓	D1,D2		100.000	100.000	

Demand Set Details

Name	Scenario Name	Time Period Name	Description	Traffic Profile Type	Model Start Time (HH:mm)	Model Finish Time (HH:mm)	Model Time Period Length (min)	Time Segment Length (min)	Results For Central Hour Only	Single Time Segment Only	Locked	Run Automatically	Use Relationship	Relationship
Scenario 1, 2017 AM	Scenario 1	2017 AM	Includes Clay Lane (2004 Turn Count)	ONE HOUR	07:45	09:15	90	15				✓		

Junction Network

Junctions

Name	Junction Type	Arm Order	Grade Separated	Large Roundabout	Do Geometric Delay	Junction Delay (s)	Junction LOS
Southern Roundabout	Roundabout	A,B,C,D				10.11	B

Junction Network Options

Driving Side	Lighting
Left	Normal/unknown

Arms

Arms

Arm	Name	Description
A	Northern Arm	Link to Northern Roundabout
B	Eastern Off-Slip	
C	Southern Arm	
D	Western On-Slip + Clay Lane	

Capacity Options

Arm	Minimum Capacity (PCU/hr)	Maximum Capacity (PCU/hr)	Assume Flat Start Profile	Initial Queue (PCU)
A	0.00	99999.00		0.00
B	0.00	99999.00		0.00
C	0.00	99999.00		0.00
D	0.00	99999.00		0.00

Roundabout Geometry

Arm	V - Approach road half-width (m)	E - Entry width (m)	I' - Effective flare length (m)	R - Entry radius (m)	D - Inscribed circle diameter (m)	PHI - Conflict (entry) angle (deg)	Exit Only
A	3.70	6.50	2.50	24.80	40.10	52.50	
B	8.50	9.40	14.00	36.80	40.10	16.30	
C	4.60	4.60	0.00	50.50	40.10	10.00	
D	4.50	4.50	0.00	19.90	40.10	20.50	

Geometries for Arm C are measured opposite Arm B. Geometries for Arm A (if relevant) are measured opposite Arm D.

Pedestrian Crossings

Arm	Crossing Type
A	None
B	None
C	None
D	None

Slope / Intercept / Capacity

Roundabout Slope and Intercept used in model

Arm	Enter slope and intercept directly	Entered slope	Entered intercept (PCU/hr)	Final Slope	Final Intercept (PCU/hr)
A		(calculated)	(calculated)	0.524	1216.561
B		(calculated)	(calculated)	0.922	2997.406
C		(calculated)	(calculated)	0.638	1531.694
D		(calculated)	(calculated)	0.593	1408.113

The slope and intercept shown above include any corrections and adjustments.

Traffic Flows

Demand Set Data Options

Default Vehicle Mix	Vehicle Mix Varies Over Time	Vehicle Mix Varies Over Turn	Vehicle Mix Varies Over Entry	Vehicle Mix Source	PCU Factor for a HV (PCU)	Default Turning Proportions	Estimate from entry/exit counts	Turning Proportions Vary Over Time	Turning Proportions Vary Over Turn	Turning Proportions Vary Over Entry
		✓	✓	HV Percentages	2.00				✓	✓

Entry Flows

General Flows Data

Arm	Profile Type	Use Turning Counts	Average Demand Flow (PCU/hr)	Flow Scaling Factor (%)
A	ONE HOUR	✓	901.00	100.000
B	ONE HOUR	✓	843.00	100.000
C	ONE HOUR	✓	702.00	100.000
D	ONE HOUR	✓	50.00	100.000

Turning Proportions

Turning Counts or Proportions (PCU/hr) - Junction 1 (for whole period)

		To			
		A	B	C	D
From	A	0.000	0.000	855.000	46.000
	B	488.000	0.000	345.000	10.000
	C	513.000	0.000	0.000	189.000
	D	30.000	0.000	20.000	0.000

Turning Proportions (PCU) - Junction 1 (for whole period)

		To			
		A	B	C	D
From	A	0.00	0.00	0.95	0.05
	B	0.58	0.00	0.41	0.01
	C	0.73	0.00	0.00	0.27
	D	0.60	0.00	0.40	0.00

Vehicle Mix

Average PCU Per Vehicle - Junction 1 (for whole period)

		To			
		A	B	C	D
From	A	1.000	1.000	1.030	1.000
	B	1.000	1.000	1.000	1.000
	C	1.030	1.000	1.000	1.000
	D	1.000	1.000	1.000	1.000

Heavy Vehicle Percentages - Junction 1 (for whole period)

		To			
		A	B	C	D
From	A	0.000	0.000	3.000	0.000
	B	0.000	0.000	0.000	0.000
	C	3.000	0.000	0.000	0.000
	D	0.000	0.000	0.000	0.000

Results

Results Summary for whole modelled period

Arm	Max RFC	Max Delay (s)	Max Queue (PCU)	Max LOS	Average Demand (PCU/hr)	Total Junction Arrivals (PCU)	Total Queueing Delay (PCU-min)	Average Queueing Delay (s)	Rate Of Queueing Delay (PCU-min/min)	Inclusive Total Queueing Delay (PCU-min)	Inclusive Average Queueing Delay (s)
A	0.82	17.16	4.56	C	826.77	1240.16	228.59	11.06	2.54	228.63	11.06
B	0.45	3.17	0.81	A	773.55	1160.33	50.52	2.61	0.56	50.52	2.61
C	0.67	9.75	2.06	A	644.17	966.25	114.19	7.09	1.27	114.20	7.09
D	0.07	5.15	0.08	A	45.88	68.82	5.17	4.51	0.06	5.17	4.51

Main Results for each time segment

Main results: (07:45-08:00)

Arm	Total Demand (PCU/hr)	Junction Arrivals (PCU)	Entry Flow (PCU/hr)	Exit Flow (PCU/hr)	Circulating Flow (PCU/hr)	Pedestrian Demand (Ped/hr)	Capacity (PCU/hr)	Saturation Capacity (PCU/hr)	RFC	Start Queue (PCU)	End Queue (PCU)	Delay (s)	LOS
A	678.32	169.58	673.15	773.14	14.99	0.00	1208.70	1125.13	0.561	0.00	1.29	6.848	A
B	634.65	158.66	633.19	0.00	688.14	0.00	2363.12	1799.63	0.269	0.00	0.37	2.079	A
C	528.50	132.13	525.62	912.91	408.42	0.00	1271.12	816.78	0.416	0.00	0.72	4.915	A
D	37.64	9.41	37.48	183.39	750.65	0.00	962.74	435.88	0.039	0.00	0.04	3.891	A

Main results: (08:00-08:15)

Arm	Total Demand (PCU/hr)	Junction Arrivals (PCU)	Entry Flow (PCU/hr)	Exit Flow (PCU/hr)	Circulating Flow (PCU/hr)	Pedestrian Demand (Ped/hr)	Capacity (PCU/hr)	Saturation Capacity (PCU/hr)	RFC	Start Queue (PCU)	End Queue (PCU)	Delay (s)	LOS
A	809.98	202.50	807.00	925.43	17.96	0.00	1207.14	1125.13	0.671	1.29	2.04	9.183	A
B	757.84	189.46	757.26	0.00	824.96	0.00	2237.01	1799.63	0.339	0.37	0.51	2.431	A
C	631.08	157.77	629.65	1093.67	488.55	0.00	1220.00	816.78	0.517	0.72	1.08	6.215	A
D	44.95	11.24	44.90	219.70	898.49	0.00	875.03	435.88	0.051	0.04	0.05	4.336	A

Main results: (08:15-08:30)

Arm	Total Demand (PCU/hr)	Junction Arrivals (PCU)	Entry Flow (PCU/hr)	Exit Flow (PCU/hr)	Circulating Flow (PCU/hr)	Pedestrian Demand (Ped/hr)	Capacity (PCU/hr)	Saturation Capacity (PCU/hr)	RFC	Start Queue (PCU)	End Queue (PCU)	Delay (s)	LOS
A	992.02	248.00	982.71	1131.63	21.98	0.00	1205.03	1125.13	0.823	2.04	4.37	16.003	C
B	928.16	232.04	926.97	0.00	1004.69	0.00	2071.35	1799.63	0.448	0.51	0.81	3.143	A
C	772.92	193.23	769.12	1333.88	597.78	0.00	1150.32	816.78	0.672	1.08	2.03	9.553	A
D	55.05	13.76	54.95	268.24	1098.66	0.00	756.27	435.88	0.073	0.05	0.08	5.133	A

Main results: (08:30-08:45)

Arm	Total Demand (PCU/hr)	Junction Arrivals (PCU)	Entry Flow (PCU/hr)	Exit Flow (PCU/hr)	Circulating Flow (PCU/hr)	Pedestrian Demand (Ped/hr)	Capacity (PCU/hr)	Saturation Capacity (PCU/hr)	RFC	Start Queue (PCU)	End Queue (PCU)	Delay (s)	LOS
A	992.02	248.00	991.26	1135.04	22.02	0.00	1205.01	1125.13	0.823	4.37	4.56	17.157	C
B	928.16	232.04	928.13	0.00	1013.28	0.00	2063.43	1799.63	0.450	0.81	0.81	3.170	A
C	772.92	193.23	772.78	1342.51	598.90	0.00	1149.60	816.78	0.672	2.03	2.06	9.752	A
D	55.05	13.76	55.05	269.67	1102.01	0.00	754.28	435.88	0.073	0.08	0.08	5.148	A

Main results: (08:45-09:00)

Arm	Total Demand (PCU/hr)	Junction Arrivals (PCU)	Entry Flow (PCU/hr)	Exit Flow (PCU/hr)	Circulating Flow (PCU/hr)	Pedestrian Demand (Ped/hr)	Capacity (PCU/hr)	Saturation Capacity (PCU/hr)	RFC	Start Queue (PCU)	End Queue (PCU)	Delay (s)	LOS
A	809.98	202.50	819.56	930.37	18.02	0.00	1207.11	1125.13	0.671	4.56	2.16	9.778	A
B	757.84	189.46	759.02	0.00	837.58	0.00	2225.38	1799.63	0.341	0.81	0.52	2.456	A
C	631.08	157.77	634.88	1106.37	490.23	0.00	1218.93	816.78	0.518	2.06	1.11	6.337	A
D	44.95	11.24	45.04	221.78	903.34	0.00	872.15	435.88	0.052	0.08	0.05	4.352	A

Main results: (09:00-09:15)

Arm	Total Demand (PCU/hr)	Junction Arrivals (PCU)	Entry Flow (PCU/hr)	Exit Flow (PCU/hr)	Circulating Flow (PCU/hr)	Pedestrian Demand (Ped/hr)	Capacity (PCU/hr)	Saturation Capacity (PCU/hr)	RFC	Start Queue (PCU)	End Queue (PCU)	Delay (s)	LOS
A	678.32	169.58	681.61	777.67	15.08	0.00	1208.65	1125.13	0.561	2.16	1.34	7.067	A
B	634.65	158.66	635.25	0.00	696.69	0.00	2355.24	1799.63	0.269	0.52	0.37	2.093	A
C	528.50	132.13	530.01	921.87	410.07	0.00	1270.07	816.78	0.416	1.11	0.73	4.979	A
D	37.64	9.41	37.70	185.03	755.05	0.00	960.13	435.88	0.039	0.05	0.04	3.902	A

Queueing Delay Results for each time segment

Queueing Delay results: (07:45-08:00)

Arm	Queueing Total Delay (PCU-min)	Queueing Rate Of Delay (PCU-min/min)	Average Delay Per Arriving Vehicle (s)	Unsignalised Level Of Service	Signalised Level Of Service
A	18.41	1.23	6.848	A	A
B	5.41	0.36	2.079	A	A
C	10.45	0.70	4.915	A	A
D	0.60	0.04	3.891	A	A

Queueing Delay results: (08:00-08:15)

Arm	Queueing Total Delay (PCU-min)	Queueing Rate Of Delay (PCU-min/min)	Average Delay Per Arriving Vehicle (s)	Unsignalised Level Of Service	Signalised Level Of Service
A	28.95	1.93	9.183	A	A
B	7.55	0.50	2.431	A	A
C	15.67	1.04	6.215	A	A
D	0.80	0.05	4.336	A	A

Queueing Delay results: (08:15-08:30)

Arm	Queueing Total Delay (PCU-min)	Queueing Rate Of Delay (PCU-min/min)	Average Delay Per Arriving Vehicle (s)	Unsignalised Level Of Service	Signalised Level Of Service
A	58.20	3.88	16.003	C	B
B	11.87	0.79	3.143	A	A
C	28.61	1.91	9.553	A	A
D	1.15	0.08	5.133	A	A

Queueing Delay results: (08:30-08:45)

Arm	Queueing Total Delay (PCU-min)	Queueing Rate Of Delay (PCU-min/min)	Average Delay Per Arriving Vehicle (s)	Unsignalised Level Of Service	Signalised Level Of Service
A	67.19	4.48	17.157	C	B
B	12.18	0.81	3.170	A	A
C	30.74	2.05	9.752	A	A
D	1.17	0.08	5.148	A	A

Queueing Delay results: (08:45-09:00)

Arm	Queueing Total Delay (PCU-min)	Queueing Rate Of Delay (PCU-min/min)	Average Delay Per Arriving Vehicle (s)	Unsignalised Level Of Service	Signalised Level Of Service
A	34.88	2.33	9.778	A	A
B	7.90	0.53	2.456	A	A
C	17.39	1.16	6.337	A	A
D	0.83	0.06	4.352	A	A

Queueing Delay results: (09:00-09:15)

Arm	Queueing Total Delay (PCU-min)	Queueing Rate Of Delay (PCU-min/min)	Average Delay Per Arriving Vehicle (s)	Unsignalised Level Of Service	Signalised Level Of Service
A	20.96	1.40	7.067	A	A
B	5.62	0.37	2.093	A	A
C	11.33	0.76	4.979	A	A
D	0.62	0.04	3.902	A	A

Design Test Layout 1 - Scenario 1, 2017 PM

Data Errors and Warnings

No errors or warnings

Analysis Set Details

Name	Roundabout Capacity Model	Description	Include In Report	Use Specific Demand Set(s)	Specific Demand Set(s)	Locked	Network Flow Scaling Factor (%)	Network Capacity Scaling Factor (%)	Reason For Scaling Factors
Design Test Layout 1	ARCADY		✓	✓	D1,D2		100.000	100.000	

Demand Set Details

Name	Scenario Name	Time Period Name	Description	Traffic Profile Type	Model Start Time (HH:mm)	Model Finish Time (HH:mm)	Model Time Period Length (min)	Time Segment Length (min)	Results For Central Hour Only	Single Time Segment Only	Locked	Run Automatically	Use Relationship	Relationship
Scenario 1, 2017 PM	Scenario 1	2017 PM	Includes Clay Lane (2004 Turn Count)	ONE HOUR	16:45	18:15	90	15				✓		

Junction Network

Junctions

Name	Junction Type	Arm Order	Grade Separated	Large Roundabout	Do Geometric Delay	Junction Delay (s)	Junction LOS
Southern Roundabout	Roundabout	A,B,C,D				11.47	B

Junction Network Options

Driving Side	Lighting
Left	Normal/unknown

Arms

Arms

Arm	Name	Description
A	Northern Arm	Link to Northern Roundabout
B	Eastern Off-Slip	
C	Southern Arm	
D	Western On-Slip + Clay Lane	

Capacity Options

Arm	Minimum Capacity (PCU/hr)	Maximum Capacity (PCU/hr)	Assume Flat Start Profile	Initial Queue (PCU)
A	0.00	99999.00		0.00
B	0.00	99999.00		0.00
C	0.00	99999.00		0.00
D	0.00	99999.00		0.00

Roundabout Geometry

Arm	V - Approach road half-width (m)	E - Entry width (m)	I' - Effective flare length (m)	R - Entry radius (m)	D - Inscribed circle diameter (m)	PHI - Conflict (entry) angle (deg)	Exit Only
A	3.70	6.50	2.50	24.80	40.10	52.50	
B	8.50	9.40	14.00	36.80	40.10	16.30	
C	4.60	4.60	0.00	50.50	40.10	10.00	
D	4.50	4.50	0.00	19.90	40.10	20.50	

Geometries for Arm C are measured opposite Arm B. Geometries for Arm A (if relevant) are measured opposite Arm D.

Pedestrian Crossings

Arm	Crossing Type
A	None
B	None
C	None
D	None

Slope / Intercept / Capacity

Roundabout Slope and Intercept used in model

Arm	Enter slope and intercept directly	Entered slope	Entered intercept (PCU/hr)	Final Slope	Final Intercept (PCU/hr)
A		(calculated)	(calculated)	0.524	1216.561
B		(calculated)	(calculated)	0.922	2997.406
C		(calculated)	(calculated)	0.638	1531.694
D		(calculated)	(calculated)	0.593	1408.113

The slope and intercept shown above include any corrections and adjustments.

Traffic Flows

Demand Set Data Options

Default Vehicle Mix	Vehicle Mix Varies Over Time	Vehicle Mix Varies Over Turn	Vehicle Mix Varies Over Entry	Vehicle Mix Source	PCU Factor for a HV (PCU)	Default Turning Proportions	Estimate from entry/exit counts	Turning Proportions Vary Over Time	Turning Proportions Vary Over Turn	Turning Proportions Vary Over Entry
		✓	✓	HV Percentages	2.00				✓	✓

Entry Flows

General Flows Data

Arm	Profile Type	Use Turning Counts	Average Demand Flow (PCU/hr)	Flow Scaling Factor (%)
A	ONE HOUR	✓	894.00	100.000
B	ONE HOUR	✓	471.00	100.000
C	ONE HOUR	✓	802.00	100.000
D	ONE HOUR	✓	25.00	100.000

Turning Proportions

Turning Counts or Proportions (PCU/hr) - Junction 1 (for whole period)

		To			
		A	B	C	D
From	A	0.000	0.000	700.000	194.000
	B	271.000	0.000	180.000	20.000
	C	617.000	0.000	0.000	185.000
	D	15.000	0.000	10.000	0.000

Turning Proportions (PCU) - Junction 1 (for whole period)

		To			
		A	B	C	D
From	A	0.00	0.00	0.78	0.22
	B	0.58	0.00	0.38	0.04
	C	0.77	0.00	0.00	0.23
	D	0.60	0.00	0.40	0.00

Vehicle Mix

Average PCU Per Vehicle - Junction 1 (for whole period)

		To			
		A	B	C	D
From	A	1.000	1.000	1.030	1.000
	B	1.000	1.000	1.000	1.000
	C	1.030	1.000	1.000	1.000
	D	1.000	1.000	1.000	1.000

Heavy Vehicle Percentages - Junction 1 (for whole period)

		To			
		A	B	C	D
From	A	0.000	0.000	3.000	0.000
	B	0.000	0.000	0.000	0.000
	C	3.000	0.000	0.000	0.000
	D	0.000	0.000	0.000	0.000

Results

Results Summary for whole modelled period

Arm	Max RFC	Max Delay (s)	Max Queue (PCU)	Max LOS	Average Demand (PCU/hr)	Total Junction Arrivals (PCU)	Total Queueing Delay (PCU-min)	Average Queueing Delay (s)	Rate Of Queueing Delay (PCU-min/min)	Inclusive Total Queueing Delay (PCU-min)	Inclusive Average Queueing Delay (s)
A	0.81	16.10	4.25	C	820.35	1230.53	217.20	10.59	2.41	217.24	10.59
B	0.25	2.30	0.33	A	432.20	648.30	22.09	2.04	0.25	22.09	2.04
C	0.74	11.91	2.86	B	735.93	1103.89	149.50	8.13	1.66	149.52	8.13
D	0.03	4.50	0.03	A	22.94	34.41	2.32	4.05	0.03	2.32	4.05

Main Results for each time segment

Main results: (16:45-17:00)

Arm	Total Demand (PCU/hr)	Junction Arrivals (PCU)	Entry Flow (PCU/hr)	Exit Flow (PCU/hr)	Circulating Flow (PCU/hr)	Pedestrian Demand (Ped/hr)	Capacity (PCU/hr)	Saturation Capacity (PCU/hr)	RFC	Start Queue (PCU)	End Queue (PCU)	Delay (s)	LOS
A	673.05	168.26	668.03	676.68	7.50	0.00	1212.63	1113.71	0.555	0.00	1.26	6.704	A
B	354.59	88.65	353.89	0.00	675.53	0.00	2374.75	1790.09	0.149	0.00	0.18	1.781	A
C	603.79	150.95	600.28	665.81	363.61	0.00	1299.71	671.90	0.465	0.00	0.88	5.239	A
D	18.82	4.71	18.75	298.46	665.43	0.00	1013.31	490.33	0.019	0.00	0.02	3.619	A

Main results: (17:00-17:15)

Arm	Total Demand (PCU/hr)	Junction Arrivals (PCU)	Entry Flow (PCU/hr)	Exit Flow (PCU/hr)	Circulating Flow (PCU/hr)	Pedestrian Demand (Ped/hr)	Capacity (PCU/hr)	Saturation Capacity (PCU/hr)	RFC	Start Queue (PCU)	End Queue (PCU)	Delay (s)	LOS
A	803.69	200.92	800.87	810.15	8.98	0.00	1211.85	1113.71	0.663	1.26	1.96	8.900	A
B	423.42	105.85	423.20	0.00	809.85	0.00	2250.93	1790.08	0.188	0.18	0.23	1.969	A
C	720.98	180.25	719.05	797.79	435.26	0.00	1254.01	671.91	0.575	0.88	1.36	6.859	A
D	22.47	5.62	22.45	357.63	796.68	0.00	935.43	490.33	0.024	0.02	0.02	3.942	A

Main results: (17:15-17:30)

Arm	Total Demand (PCU/hr)	Junction Arrivals (PCU)	Entry Flow (PCU/hr)	Exit Flow (PCU/hr)	Circulating Flow (PCU/hr)	Pedestrian Demand (Ped/hr)	Capacity (PCU/hr)	Saturation Capacity (PCU/hr)	RFC	Start Queue (PCU)	End Queue (PCU)	Delay (s)	LOS
A	984.31	246.08	975.78	989.58	10.99	0.00	1210.79	1113.71	0.813	1.96	4.09	15.139	C
B	518.58	129.65	518.19	0.00	986.78	0.00	2087.85	1790.09	0.248	0.23	0.33	2.293	A
C	883.02	220.75	877.31	973.06	531.90	0.00	1192.35	671.90	0.741	1.36	2.79	11.483	B
D	27.53	6.88	27.49	436.12	973.09	0.00	830.77	490.33	0.033	0.02	0.03	4.481	A

Main results: (17:30-17:45)

Arm	Total Demand (PCU/hr)	Junction Arrivals (PCU)	Entry Flow (PCU/hr)	Exit Flow (PCU/hr)	Circulating Flow (PCU/hr)	Pedestrian Demand (Ped/hr)	Capacity (PCU/hr)	Saturation Capacity (PCU/hr)	RFC	Start Queue (PCU)	End Queue (PCU)	Delay (s)	LOS
A	984.31	246.08	983.67	994.00	11.01	0.00	1210.79	1113.71	0.813	4.09	4.25	16.098	C
B	518.58	129.65	518.57	0.00	994.68	0.00	2080.57	1790.09	0.249	0.33	0.33	2.304	A
C	883.02	220.75	882.73	979.40	533.85	0.00	1191.10	671.90	0.741	2.79	2.86	11.912	B
D	27.53	6.88	27.52	439.10	977.48	0.00	828.16	490.33	0.033	0.03	0.03	4.496	A

Main results: (17:45-18:00)

Arm	Total Demand (PCU/hr)	Junction Arrivals (PCU)	Entry Flow (PCU/hr)	Exit Flow (PCU/hr)	Circulating Flow (PCU/hr)	Pedestrian Demand (Ped/hr)	Capacity (PCU/hr)	Saturation Capacity (PCU/hr)	RFC	Start Queue (PCU)	End Queue (PCU)	Delay (s)	LOS
A	803.69	200.92	812.41	816.47	9.00	0.00	1211.84	1113.71	0.663	4.25	2.07	9.416	A
B	423.42	105.85	423.81	0.00	821.42	0.00	2240.27	1790.08	0.189	0.33	0.23	1.982	A
C	720.98	180.25	726.76	807.09	438.14	0.00	1252.17	671.91	0.576	2.86	1.41	7.085	A
D	22.47	5.62	22.51	361.94	802.96	0.00	931.71	490.33	0.024	0.03	0.02	3.959	A

Main results: (18:00-18:15)

Arm	Total Demand (PCU/hr)	Junction Arrivals (PCU)	Entry Flow (PCU/hr)	Exit Flow (PCU/hr)	Circulating Flow (PCU/hr)	Pedestrian Demand (Ped/hr)	Capacity (PCU/hr)	Saturation Capacity (PCU/hr)	RFC	Start Queue (PCU)	End Queue (PCU)	Delay (s)	LOS
A	673.05	168.26	676.15	681.55	7.54	0.00	1212.61	1113.71	0.555	2.07	1.30	6.905	A
B	354.59	88.65	354.82	0.00	683.69	0.00	2367.22	1790.09	0.150	0.23	0.18	1.791	A
C	603.79	150.95	605.84	672.56	365.95	0.00	1298.22	671.90	0.465	1.41	0.90	5.335	A
D	18.82	4.71	18.84	301.54	670.25	0.00	1010.45	490.33	0.019	0.02	0.02	3.632	A

Queueing Delay Results for each time segment

Queueing Delay results: (16:45-17:00)

Arm	Queueing Total Delay (PCU-min)	Queueing Rate Of Delay (PCU-min/min)	Average Delay Per Arriving Vehicle (s)	Unsignalised Level Of Service	Signalised Level Of Service
A	17.90	1.19	6.704	A	A
B	2.60	0.17	1.781	A	A
C	12.68	0.85	5.239	A	A
D	0.28	0.02	3.619	A	A

Queueing Delay results: (17:00-17:15)

Arm	Queueing Total Delay (PCU-min)	Queueing Rate Of Delay (PCU-min/min)	Average Delay Per Arriving Vehicle (s)	Unsignalised Level Of Service	Signalised Level Of Service
A	27.91	1.86	8.900	A	A
B	3.43	0.23	1.969	A	A
C	19.62	1.31	6.859	A	A
D	0.36	0.02	3.942	A	A

Queueing Delay results: (17:15-17:30)

Arm	Queueing Total Delay (PCU-min)	Queueing Rate Of Delay (PCU-min/min)	Average Delay Per Arriving Vehicle (s)	Unsignalised Level Of Service	Signalised Level Of Service
A	54.97	3.66	15.139	C	B
B	4.88	0.33	2.293	A	A
C	38.55	2.57	11.483	B	B
D	0.50	0.03	4.481	A	A

Queueing Delay results: (17:30-17:45)

Arm	Queueing Total Delay (PCU-min)	Queueing Rate Of Delay (PCU-min/min)	Average Delay Per Arriving Vehicle (s)	Unsignalised Level Of Service	Signalised Level Of Service
A	62.84	4.19	16.098	C	B
B	4.96	0.33	2.304	A	A
C	42.45	2.83	11.912	B	B
D	0.51	0.03	4.496	A	A

Queueing Delay results: (17:45-18:00)

Arm	Queueing Total Delay (PCU-min)	Queueing Rate Of Delay (PCU-min/min)	Average Delay Per Arriving Vehicle (s)	Unsignalised Level Of Service	Signalised Level Of Service
A	33.29	2.22	9.416	A	A
B	3.54	0.24	1.982	A	A
C	22.28	1.49	7.085	A	A
D	0.38	0.03	3.959	A	A

Queueing Delay results: (18:00-18:15)

Arm	Queueing Total Delay (PCU-min)	Queueing Rate Of Delay (PCU-min/min)	Average Delay Per Arriving Vehicle (s)	Unsignalised Level Of Service	Signalised Level Of Service
A	20.30	1.35	6.905	A	A
B	2.67	0.18	1.791	A	A
C	13.92	0.93	5.335	A	A
D	0.29	0.02	3.632	A	A

Appendix F.9

A6MARR/ B5166 Styal Road LinSig Output

A6MARR / B5166 Styal Road LinSig Output

Full Input Data And Results

User and Project Details

Project:	A6MARR
Title:	Styal Rd/A6MARR
Location:	
File name:	7 - A6MARR_Styal Rd.lsg3x
Author:	PW/GDC
Company:	Atkins
Address:	Bank Chambers, Faulkner Street, Manchester
Notes:	

Network Layout Diagram

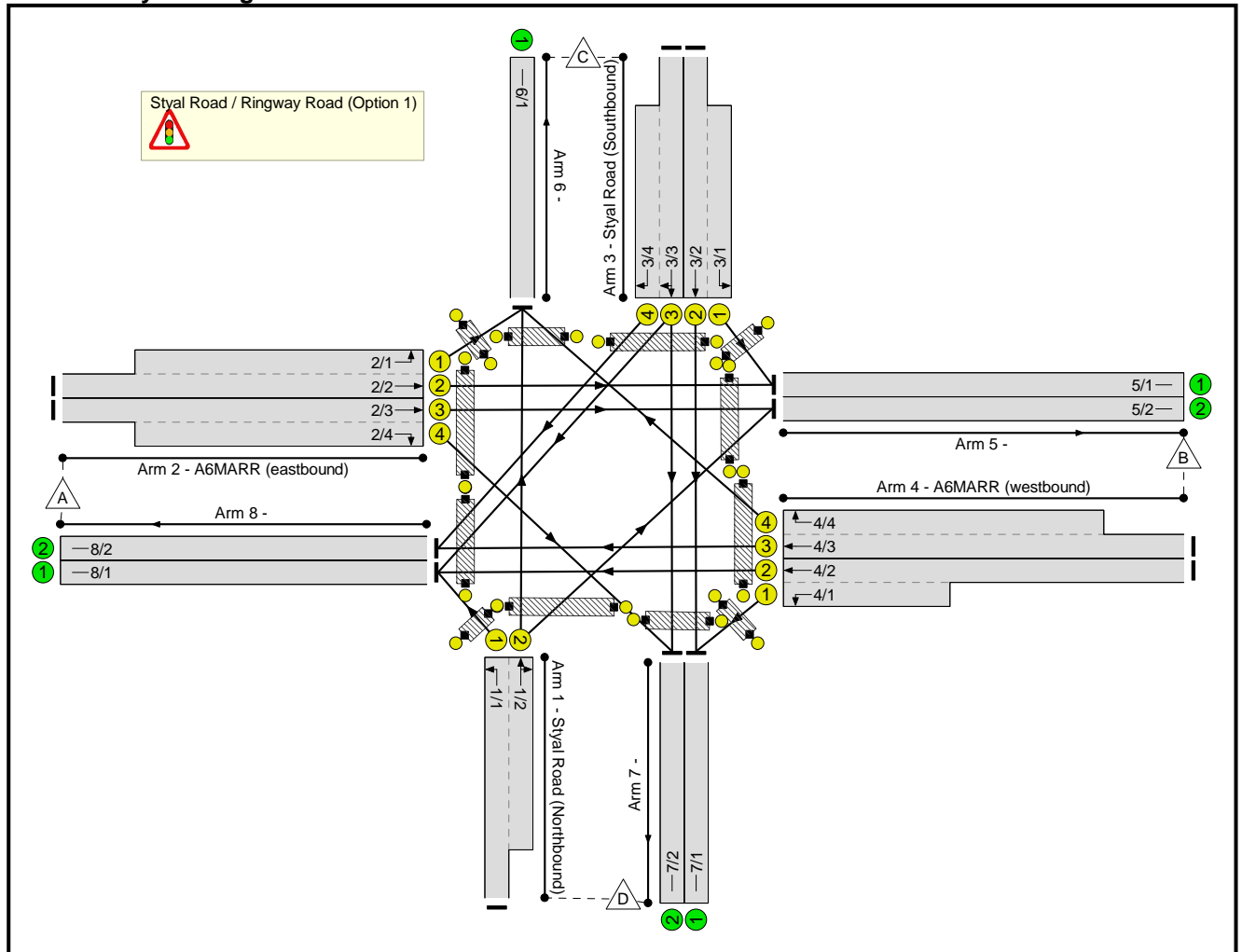

Phase Diagram

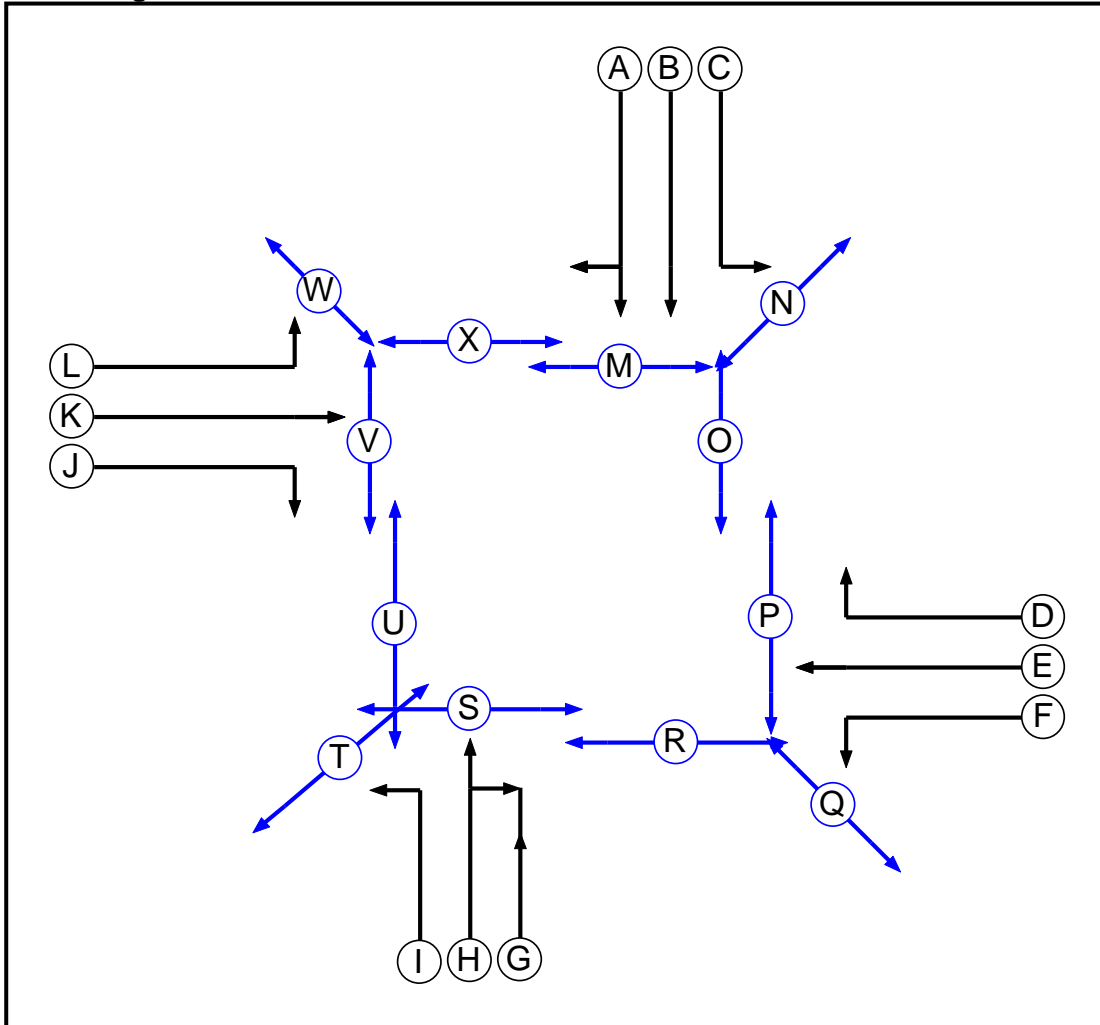

Phase Input Data

Phase Name	Phase Type	Assoc. Phase	Street Min	Cont Min
A	Traffic		7	7
B	Traffic		7	7
C	Traffic		2	2
D	Traffic		4	4
E	Traffic		7	7
F	Traffic		7	7
G	Traffic		7	7
H	Traffic		3	3
I	Traffic		3	3
J	Traffic		7	7
K	Traffic		7	7
L	Traffic		7	7

Phase Name	Phase Type	Assoc. Phase	Street Min	Cont Min
M	Pedestrian		5	5
N	Pedestrian		5	5
O	Pedestrian		3	3
P	Pedestrian		5	5
Q	Pedestrian		5	5
R	Pedestrian		5	5
S	Pedestrian		5	5
T	Pedestrian		5	5
U	Pedestrian		5	5
V	Pedestrian		5	5
W	Pedestrian		5	5
X	Pedestrian		5	5

Phase Intergreens Matrix

		Starting Phase																							
		A	B	C	D	E	F	G	H	I	J	K	L	M	N	O	P	Q	R	S	T	U	V	W	X
Terminating Phase	A	-	-	6	7	9	5	6	9	5	5	-	5	-	-	-	-	9	-	-	9	-	-	-	-
	B	-	-	6	7	9	5	6	9	5	5	-	5	-	-	-	-	9	-	-	9	-	-	-	-
	C	-	-	-	-	-	5	5	-	-	5	-	-	5	-	-	-	-	-	-	-	-	-	-	-
	D	5	5	-	-	-	5	5	-	5	9	10	-	-	-	5	-	-	-	-	-	-	-	-	10
	E	5	5	-	-	-	6	6	8	5	-	-	-	-	-	5	-	-	-	-	-	9	-	-	-
	F	5	5	-	-	-	-	-	-	5	-	-	-	-	-	-	5	-	-	-	-	-	-	-	-
	G	6	6	8	5	5	-	-	-	5	5	-	-	-	9	-	-	-	5	-	-	-	-	-	-
	H	6	6	8	5	5	-	-	-	6	7	9	-	-	9	-	-	-	5	-	-	-	-	-	9
	I	5	5	-	-	5	-	-	-	-	-	-	-	-	-	-	-	-	-	5	-	-	-	-	-
	J	5	5	-	5	8	10	5	5	-	-	-	-	-	-	-	-	10	-	-	5	-	-	-	-
	K	6	6	8	5	-	-	5	5	-	-	-	-	-	9	-	-	-	-	-	5	-	-	-	-
	L	-	-	-	5	-	-	-	5	-	-	-	-	-	-	-	-	-	-	-	-	-	-	5	-
	M	13	13	-	-	-	-	-	-	-	-	-	-	-	-	-	-	-	-	-	-	-	-	-	-
	N	-	-	6	-	-	-	-	-	-	-	-	-	-	-	-	-	-	-	-	-	-	-	-	-
	O	-	-	-	-	-	9	9	-	-	9	-	-	-	-	-	-	-	-	-	-	-	-	-	-
	P	-	-	-	14	14	-	-	-	-	-	-	-	-	-	-	-	-	-	-	-	-	-	-	-
	Q	-	-	-	-	-	7	-	-	-	-	-	-	-	-	-	-	-	-	-	-	-	-	-	-
	R	8	8	-	-	-	-	-	-	8	-	-	-	-	-	-	-	-	-	-	-	-	-	-	-
	S	-	-	-	-	-	-	11	11	-	-	-	-	-	-	-	-	-	-	-	-	-	-	-	-
	T	-	-	-	-	-	-	-	-	6	-	-	-	-	-	-	-	-	-	-	-	-	-	-	-
	U	10	10	-	-	10	-	-	-	-	-	-	-	-	-	-	-	-	-	-	-	-	-	-	-
	V	-	-	-	-	-	-	-	-	-	13	13	-	-	-	-	-	-	-	-	-	-	-	-	-
	W	-	-	-	-	-	-	-	-	-	-	-	7	-	-	-	-	-	-	-	-	-	-	-	-
	X	-	-	-	7	-	-	-	7	-	-	-	-	-	-	-	-	-	-	-	-	-	-	-	-

Phases in Stage

Stage No.	Phases in Stage
1	CDEFMORSTVW
2	EFKLMNRSTX
3	IJKLMNOPQSUX
4	ABCLOPQSTVX
5	FHIMNPRUVW

Stage Diagram

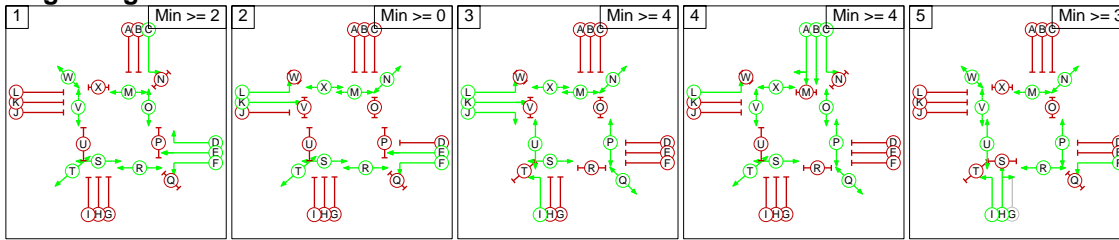

Phase Delays

Term. Stage	Start Stage	Phase	Type	Value	Cont value
1	2	C	Losing	8	8
1	2	D	Losing	3	3
1	2	O	Losing	4	4
1	2	W	Losing	6	6
2	3	E	Losing	2	2
2	3	F	Losing	2	2
2	3	T	Losing	4	4
3	4	I	Losing	8	8
3	4	J	Losing	8	8
3	4	K	Losing	7	7
3	4	N	Losing	9	9
3	4	U	Losing	3	3
4	5	A	Losing	2	2
4	5	B	Losing	2	2
4	5	C	Losing	6	6
4	5	L	Losing	6	6
4	5	O	Losing	2	2
4	5	Q	Losing	4	4
4	5	T	Losing	5	5
4	5	X	Losing	4	4
5	1	H	Losing	6	6
5	1	I	Losing	9	9
5	1	N	Losing	8	8

Prohibited Stage Change

		To Stage				
		1	2	3	4	5
From Stage	1		13	13	13	11
	2	9		11	13	11
	3	14	14		16	11
	4	14	14	13		11
	5	15	14	13	13	

Give-Way Lane Input Data

Junction: Styal Road / Ringway Road (Option 1)

There are no Opposed Lanes in this Junction

Lane Input Data

Junction: Styal Road / Ringway Road (Option 1)												
Lane	Lane Type	Phase	Start Disp.	End Disp.	Physical Length (PCU)	Sat Flow Type	Def User Saturation Flow (PCU/Hr)	Lane Width (m)	Gradient	Nearside Lane	Turns	Turning Radius (m)
1/1 (Styal Road Northbound)	U	I	2	3	60.0	Geom	-	4.50	0.00	Y	Arm 8 Left	55.00
1/2 (Styal Road Northbound)	U	H	2	3	25.0	Geom	-	4.40	0.00	Y	Arm 5 Right Arm 6 Ahead	15.00 Inf
2/1 (A6MARR eastbound)	U	L	2	3	60.9	Geom	-	5.00	0.00	Y	Arm 6 Left	25.00
2/2 (A6MARR eastbound)	U	K	2	3	60.0	Geom	-	3.60	0.00	Y	Arm 5 Ahead	Inf
2/3 (A6MARR eastbound)	U	K	2	3	60.0	Geom	-	3.60	0.00	N	Arm 5 Ahead	Inf
2/4 (A6MARR eastbound)	U	J	2	3	29.6	Geom	-	3.70	0.00	Y	Arm 7 Right	20.00
3/1 (Styal Road Southbound)	U	C	2	3	23.5	Geom	-	4.60	0.00	Y	Arm 5 Left	45.00
3/2 (Styal Road Southbound)	U	B	2	3	60.0	Geom	-	3.60	0.00	Y	Arm 7 Ahead	Inf
3/3 (Styal Road Southbound)	U	A	2	3	60.0	Geom	-	3.60	0.00	Y	Arm 7 Ahead Arm 8 Right	Inf 20.00
3/4 (Styal Road Southbound)	U	A	2	3	22.6	Geom	-	3.60	0.00	N	Arm 8 Right	15.00
4/1 (A6MARR westbound)	U	F	2	3	10.4	Geom	-	5.00	0.00	Y	Arm 7 Left	22.50
4/2 (A6MARR westbound)	U	E	2	3	60.0	Geom	-	3.80	0.00	Y	Arm 8 Ahead	Inf
4/3 (A6MARR westbound)	U	E	2	3	60.0	Geom	-	3.80	0.00	N	Arm 8 Ahead	Inf

4/4 (A6MARR (westbound))	U	D	2	3	38.3	Geo m	-	3.75	0.00	Y	Arm 6 Right	30.00
5/1	U		2	3	60.0	Inf	-	-	-	-	-	-
5/2	U		2	3	60.0	Inf	-	-	-	-	-	-
6/1	U		2	3	60.0	Inf	-	-	-	-	-	-
7/1	U		2	3	60.0	Inf	-	-	-	-	-	-
7/2	U		2	3	60.0	Inf	-	-	-	-	-	-
8/1	U		2	3	60.0	Inf	-	-	-	-	-	-
8/2	U		2	3	60.0	Inf	-	-	-	-	-	-

Traffic Flow Groups

Flow Group	Start Time	End Time	Duration	Formula
1: 'AM Peak 2017'	08:00	09:00	01:00	
2: 'PM Peak 2017'	17:00	18:00	01:00	

Scenario 1: '2017 AM Peak' (FG1: 'AM Peak 2017', Plan 2: 'Network Control Plan 2')
Traffic Flows, Desired

Desired Flow :

	Destination					
	A	B	C	D	Tot.	
Origin	A	0	1386	553	337	2276
	B	1560	0	232	74	1866
	C	293	199	0	262	754
	D	568	37	161	0	766
	Tot.	2421	1622	946	673	5662

Traffic Lane Flows

Lane	Scenario 1: 2017 AM Peak
Junction: Styal Road / Ringway Road (Option 1)	
1/1 (with short)	766(In) 568(Out)
1/2 (short)	198
2/1 (short)	553
2/2 (with short)	1242(In) 689(Out)
2/3 (with short)	1034(In) 697(Out)
2/4 (short)	337
3/1 (short)	199
3/2 (with short)	391(In) 192(Out)
3/3 (with short)	363(In) 180(Out)
3/4 (short)	183
4/1 (short)	74
4/2 (with short)	810(In) 736(Out)
4/3 (with short)	1056(In) 824(Out)
4/4 (short)	232
5/1	888
5/2	734
6/1	946
7/1	266
7/2	407
8/1	1414
8/2	1007

Lane Saturation Flows

Junction: Styal Road / Ringway Road (Option 1)								
Lane	Lane Width (m)	Gradient	Nearside Lane	Allowed Turns	Turning Radius (m)	Turning Prop.	Sat Flow (PCU/Hr)	Flared Sat Flow (PCU/Hr)
1/1 (Styal Road (Northbound))	4.50	0.00	Y	Arm 8 Left	55.00	100.0 %	2010	2010
1/2 (Styal Road (Northbound))	4.40	0.00	Y	Arm 5 Right	15.00	18.7 %	2017	2017
				Arm 6 Ahead	Inf	81.3 %		
2/1 (A6MARR (eastbound))	5.00	0.00	Y	Arm 6 Left	25.00	100.0 %	1995	1995
2/2 (A6MARR (eastbound))	3.60	0.00	Y	Arm 5 Ahead	Inf	100.0 %	1975	1975
2/3 (A6MARR (eastbound))	3.60	0.00	N	Arm 5 Ahead	Inf	100.0 %	2115	2115
2/4 (A6MARR (eastbound))	3.70	0.00	Y	Arm 7 Right	20.00	100.0 %	1847	1847
3/1 (Styal Road (Southbound))	4.60	0.00	Y	Arm 5 Left	45.00	100.0 %	2008	2008
3/2 (Styal Road (Southbound))	3.60	0.00	Y	Arm 7 Ahead	Inf	100.0 %	1975	1975
				Arm 7 Ahead Arm 8 Right	Inf 20.00	38.9 % 61.1 %		
3/3 (Styal Road (Southbound))	3.60	0.00	Y	Arm 8 Right	20.00	100.0 %	1888	1888
3/4 (Styal Road (Southbound))	3.60	0.00	N	Arm 8 Right	15.00	100.0 %	1923	1923
4/1 (A6MARR (westbound))	5.00	0.00	Y	Arm 7 Left	22.50	100.0 %	1983	1983
4/2 (A6MARR (westbound))	3.80	0.00	Y	Arm 8 Ahead	Inf	100.0 %	1995	1995
4/3 (A6MARR (westbound))	3.80	0.00	N	Arm 8 Ahead	Inf	100.0 %	2135	2135
4/4 (A6MARR (westbound))	3.75	0.00	Y	Arm 6 Right	30.00	100.0 %	1895	1895
5/1	Infinite Saturation Flow						Inf	Inf
5/2	Infinite Saturation Flow						Inf	Inf
6/1	Infinite Saturation Flow						Inf	Inf
7/1	Infinite Saturation Flow						Inf	Inf
7/2	Infinite Saturation Flow						Inf	Inf
8/1	Infinite Saturation Flow						Inf	Inf
8/2	Infinite Saturation Flow						Inf	Inf

Scenario 2: '2017 PM Peak' (FG2: 'PM Peak 2017', Plan 2: 'Network Control Plan 2')

Traffic Flows, Desired

Desired Flow :

		Destination				
		A	B	C	D	Tot.
Origin	A	0	1720	396	497	2613
	B	1065	0	154	65	1284
	C	300	514	0	221	1035
	D	669	66	179	0	914
	Tot.	2034	2300	729	783	5846

Traffic Lane Flows

Lane	Scenario 2: 2017 PM Peak
Junction: Styal Road / Ringway Road (Option 1)	
1/1 (with short)	914(In) 669(Out)
1/2 (short)	245
2/1 (short)	396
2/2 (with short)	1241(In) 845(Out)
2/3 (with short)	1372(In) 875(Out)
2/4 (short)	497
3/1 (short)	514
3/2 (with short)	623(In) 109(Out)
3/3 (with short)	412(In) 205(Out)
3/4 (short)	207
4/1 (short)	65
4/2 (with short)	559(In) 494(Out)
4/3 (with short)	725(In) 571(Out)
4/4 (short)	154
5/1	1359
5/2	941
6/1	729
7/1	174
7/2	609
8/1	1256
8/2	778

Lane Saturation Flows

Junction: Styal Road / Ringway Road (Option 1)								
Lane	Lane Width (m)	Gradient	Nearside Lane	Allowed Turns	Turning Radius (m)	Turning Prop.	Sat Flow (PCU/Hr)	Flared Sat Flow (PCU/Hr)
1/1 (Styal Road (Northbound))	4.50	0.00	Y	Arm 8 Left	55.00	100.0 %	2010	2010
1/2 (Styal Road (Northbound))	4.40	0.00	Y	Arm 5 Right	15.00	26.9 %	2001	2001
				Arm 6 Ahead	Inf	73.1 %		
2/1 (A6MARR (eastbound))	5.00	0.00	Y	Arm 6 Left	25.00	100.0 %	1995	1995
2/2 (A6MARR (eastbound))	3.60	0.00	Y	Arm 5 Ahead	Inf	100.0 %	1975	1975
2/3 (A6MARR (eastbound))	3.60	0.00	N	Arm 5 Ahead	Inf	100.0 %	2115	2115
2/4 (A6MARR (eastbound))	3.70	0.00	Y	Arm 7 Right	20.00	100.0 %	1847	1847
3/1 (Styal Road (Southbound))	4.60	0.00	Y	Arm 5 Left	45.00	100.0 %	2008	2008
3/2 (Styal Road (Southbound))	3.60	0.00	Y	Arm 7 Ahead	Inf	100.0 %	1975	1975
				Arm 7 Ahead Arm 8 Right	Inf 20.00	54.6 % 45.4 %		
3/3 (Styal Road (Southbound))	3.60	0.00	Y	Arm 8 Right	20.00	100.0 %	1923	1923
3/4 (Styal Road (Southbound))	3.60	0.00	N	Arm 8 Right	15.00	100.0 %	1923	1923
4/1 (A6MARR (westbound))	5.00	0.00	Y	Arm 7 Left	22.50	100.0 %	1983	1983
4/2 (A6MARR (westbound))	3.80	0.00	Y	Arm 8 Ahead	Inf	100.0 %	1995	1995
4/3 (A6MARR (westbound))	3.80	0.00	N	Arm 8 Ahead	Inf	100.0 %	2135	2135
4/4 (A6MARR (westbound))	3.75	0.00	Y	Arm 6 Right	30.00	100.0 %	1895	1895
5/1				Infinite Saturation Flow			Inf	Inf
5/2				Infinite Saturation Flow			Inf	Inf
6/1				Infinite Saturation Flow			Inf	Inf
7/1				Infinite Saturation Flow			Inf	Inf
7/2				Infinite Saturation Flow			Inf	Inf
8/1				Infinite Saturation Flow			Inf	Inf
8/2				Infinite Saturation Flow			Inf	Inf

Scenario 1: '2017 AM Peak' (FG1: 'AM Peak 2017', Plan 2: 'Network Control Plan 2')

Stage Sequence Diagram

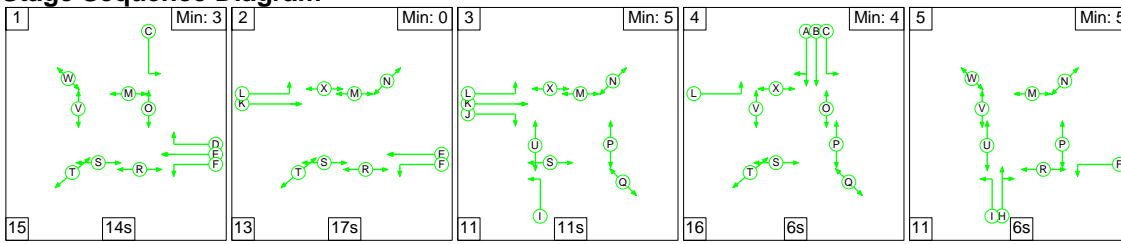

Stage Timings

Stage	1	2	3	4	5
Duration	14	17	11	6	6
Change Point	0	29	59	81	103

Signal Timings Diagram

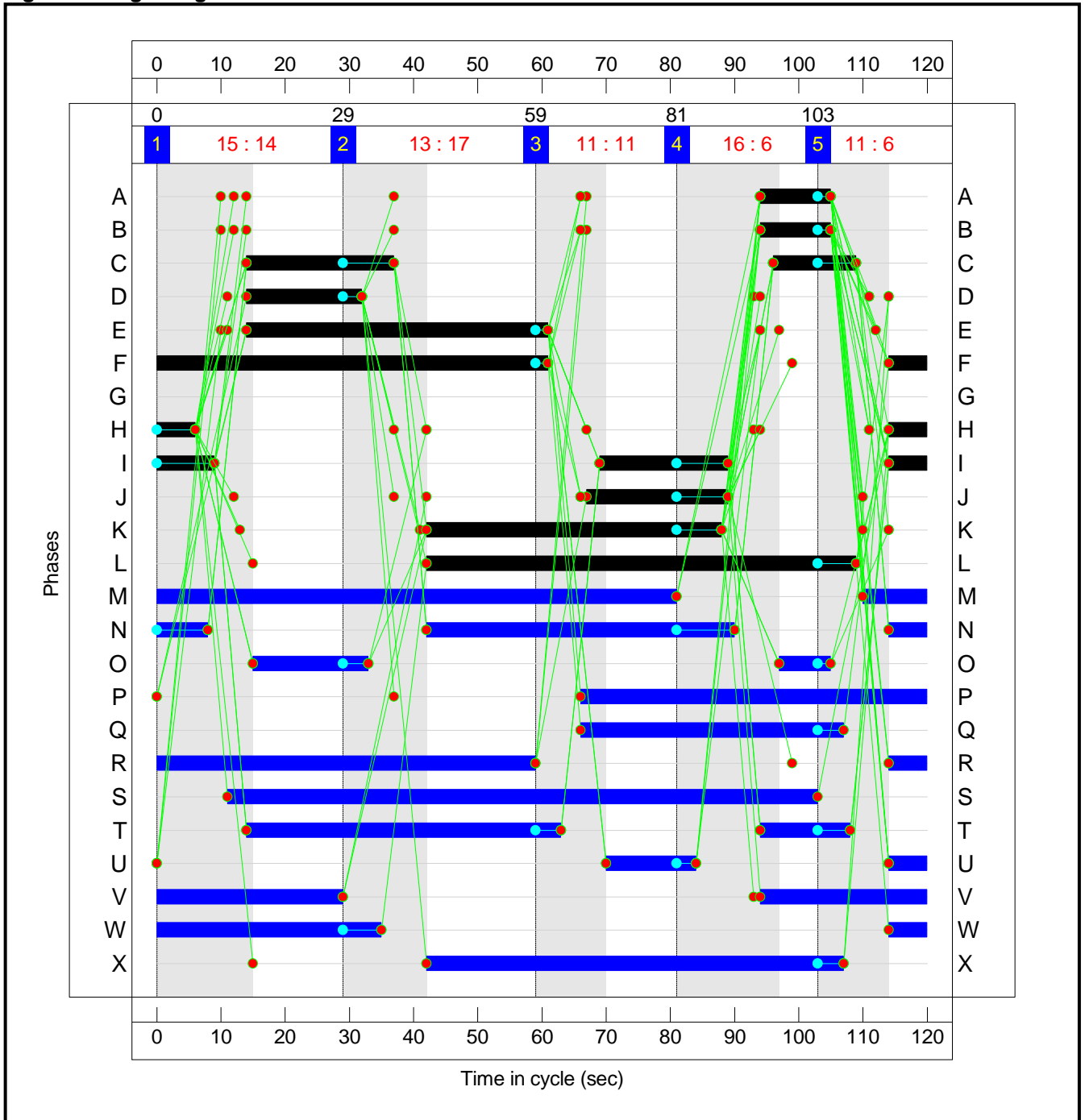

Network Layout Diagram

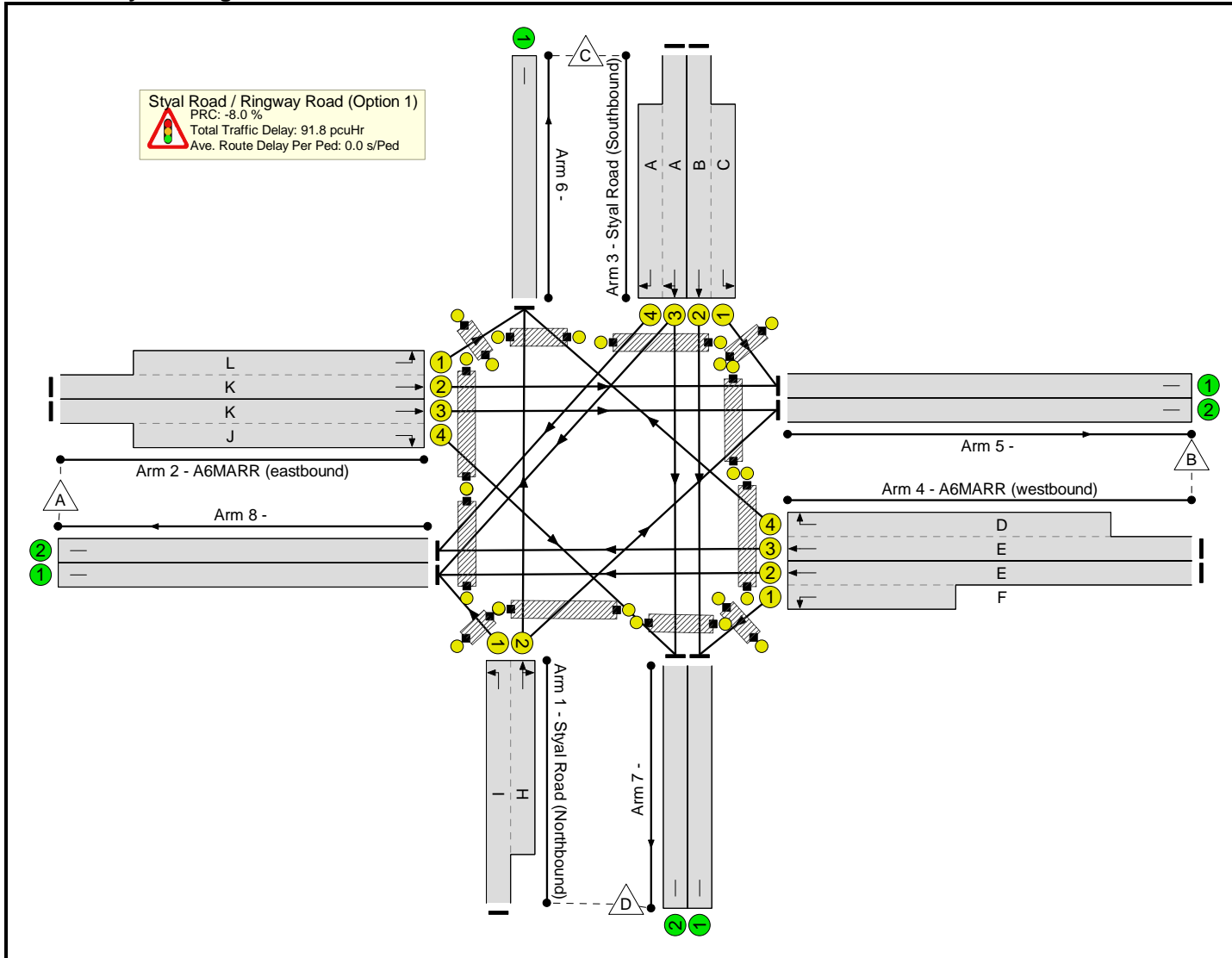

Network Results

Item	Lane Description	Lane Type	Controller Stream	Position In Filtered Route	Full Phase	Arrow Phase	Num Greens	Total Green (s)	Arrow Green (s)	Demand Flow (pcu)	Sat Flow (pcu/Hr)	Capacity (pcu)	Deg Sat (%)
Network: Styal Rd/A6MARR	-	-	N/A	-	-		-	-	-	-	-	-	97.2%
Styal Road / Ringway Road (Option 1)	-	-	N/A	-	-		-	-	-	-	-	-	97.2%
1/1+1/2	Styal Road (Northbound) Right Ahead Left	U	N/A	N/A	I H		2:1	35:12	-	766	2010:2017	620+219	91.6 : 90.6%
2/2+2/1	A6MARR (eastbound) Ahead Left	U	N/A	N/A	K L		1	46:67	-	1242	1975:1995	774+883	89.1 : 62.6%
2/3+2/4	A6MARR (eastbound) Ahead Right	U	N/A	N/A	K J		1	46:22	-	1034	2115:1847	828+354	84.1 : 95.2%
3/2+3/1	Styal Road (Southbound) Left Ahead	U	N/A	N/A	B C		1:2	11:36	-	391	1975:2008	197+205	97.2 : 97.2%
3/3+3/4	Styal Road (Southbound) Ahead Right	U	N/A	N/A	A		1	11	-	363	1888:1923	189+192	95.3 : 95.2%
4/2+4/1	A6MARR (westbound) Left Ahead	U	N/A	N/A	E F		1	47:67	-	810	1995:1983	759+76	96.9 : 96.9%
4/3+4/4	A6MARR (westbound) Right Ahead	U	N/A	N/A	E D		1	47:18	-	1056	2135:1895	854+300	96.5 : 77.3%
5/1		U	N/A	N/A	-		-	-	-	888	Inf	Inf	0.0%
5/2		U	N/A	N/A	-		-	-	-	734	Inf	Inf	0.0%
6/1		U	N/A	N/A	-		-	-	-	946	Inf	Inf	0.0%
7/1		U	N/A	N/A	-		-	-	-	266	Inf	Inf	0.0%
7/2		U	N/A	N/A	-		-	-	-	407	Inf	Inf	0.0%
8/1		U	N/A	N/A	-		-	-	-	1414	Inf	Inf	0.0%
8/2		U	N/A	N/A	-		-	-	-	1007	Inf	Inf	0.0%
Ped Link: P1	Unnamed Ped Link	-	N/A	-	N		2	62	-	0	-	0	0.0%
Ped Link: P2	Unnamed Ped Link	-	N/A	-	O		2	26	-	0	-	0	0.0%

Item	Lane Description	Lane Type	Controller Stream	Position In Filtered Route	Full Phase	Arrow Phase	Num Greens	Total Green (s)	Arrow Green (s)	Demand Flow (pcu)	Sat Flow (pcu/Hr)	Capacity (pcu)	Deg Sat (%)
Ped Link: P3	Unnamed Ped Link	-	N/A	-	P		1	54	-	0	-	0	0.0%
Ped Link: P4	Unnamed Ped Link	-	N/A	-	Q		1	41	-	0	-	0	0.0%
Ped Link: P5	Unnamed Ped Link	-	N/A	-	R		1	65	-	0	-	0	0.0%
Ped Link: P6	Unnamed Ped Link	-	N/A	-	S		1	92	-	0	-	0	0.0%
Ped Link: P7	Unnamed Ped Link	-	N/A	-	T		2	63	-	0	-	0	0.0%
Ped Link: P8	Unnamed Ped Link	-	N/A	-	U		2	20	-	0	-	0	0.0%
Ped Link: P9	Unnamed Ped Link	-	N/A	-	V		1	55	-	0	-	0	0.0%
Ped Link: P10	Unnamed Ped Link	-	N/A	-	W		1	41	-	0	-	0	0.0%
Ped Link: P11	Unnamed Ped Link	-	N/A	-	X		1	65	-	0	-	0	0.0%
Ped Link: P12	Unnamed Ped Link	-	N/A	-	M		1	91	-	0	-	0	0.0%

Item	Arriving (pcu)	Leaving (pcu)	Turners In Gaps (pcu)	Turners When Unopposed (pcu)	Turners In Intergreen (pcu)	Uniform Delay (pcuHr)	Rand + Oversat Delay (pcuHr)	Storage Area Uniform Delay (pcuHr)	Total Delay (pcuHr)	Av. Delay Per PCU (s/pcu)	Max. Back of Uniform Queue (pcu)	Rand + Oversat Queue (pcu)	Mean Max Queue (pcu)
Network: Styal Rd/A6MARR	-	-	0	0	0	54.7	37.1	0.0	91.8	-	-	-	-
Styal Road / Ringway Road (Option 1)	-	-	0	0	0	54.7	37.1	0.0	91.8	-	-	-	-
1/1+1/2	766	766	-	-	-	6.9	4.7	-	11.6	54.4	12.6	4.7	17.3
2/2+2/1	1242	1242	-	-	-	8.9	1.5	-	10.4	30.2	21.4	1.5	22.9
2/3+2/4	1034	1034	-	-	-	10.9	3.3	-	14.2	49.6	20.9	3.3	24.2
3/2+3/1	391	391	-	-	-	3.9	7.5	-	11.4	104.6	6.3	7.5	13.8
3/3+3/4	363	363	-	-	-	5.4	6.0	-	11.4	113.4	6.0	6.0	12.1
4/2+4/1	810	810	-	-	-	7.6	9.2	-	16.8	74.5	25.3	9.2	34.5
4/3+4/4	1056	1056	-	-	-	11.2	4.9	-	16.1	54.8	26.8	4.9	31.7
5/1	888	888	-	-	-	0.0	0.0	-	0.0	0.0	0.0	0.0	0.0
5/2	734	734	-	-	-	0.0	0.0	-	0.0	0.0	0.0	0.0	0.0
6/1	946	946	-	-	-	0.0	0.0	-	0.0	0.0	0.0	0.0	0.0
7/1	266	266	-	-	-	0.0	0.0	-	0.0	0.0	0.0	0.0	0.0
7/2	407	407	-	-	-	0.0	0.0	-	0.0	0.0	0.0	0.0	0.0
8/1	1414	1414	-	-	-	0.0	0.0	-	0.0	0.0	0.0	0.0	0.0
8/2	1007	1007	-	-	-	0.0	0.0	-	0.0	0.0	0.0	0.0	0.0
Ped Link: P1	0	0	-	-	-	-	-	-	-	-	-	-	-
Ped Link: P2	0	0	-	-	-	-	-	-	-	-	-	-	-
Ped Link: P3	0	0	-	-	-	-	-	-	-	-	-	-	-
Ped Link: P4	0	0	-	-	-	-	-	-	-	-	-	-	-
Ped Link: P5	0	0	-	-	-	-	-	-	-	-	-	-	-

Item	Arriving (pcu)	Leaving (pcu)	Turners In Gaps (pcu)	Turners When Unopposed (pcu)	Turners In Intergreen (pcu)	Uniform Delay (pcuHr)	Rand + Oversat Delay (pcuHr)	Storage Area Uniform Delay (pcuHr)	Total Delay (pcuHr)	Av. Delay Per PCU (s/pcu)	Max. Back of Uniform Queue (pcu)	Rand + Oversat Queue (pcu)	Mean Max Queue (pcu)
Ped Link: P6	0	0	-	-	-	-	-	-	-	-	-	-	-
Ped Link: P7	0	0	-	-	-	-	-	-	-	-	-	-	-
Ped Link: P8	0	0	-	-	-	-	-	-	-	-	-	-	-
Ped Link: P9	0	0	-	-	-	-	-	-	-	-	-	-	-
Ped Link: P10	0	0	-	-	-	-	-	-	-	-	-	-	-
Ped Link: P11	0	0	-	-	-	-	-	-	-	-	-	-	-
Ped Link: P12	0	0	-	-	-	-	-	-	-	-	-	-	-
C1			PRC for Signalled Lanes (%):		-8.0	Total Delay for Signalled Lanes (pcuHr):		91.84	Cycle Time (s): 120				
			PRC Over All Lanes (%):		-8.0	Total Delay Over All Lanes(pcuHr):		91.84					

Scenario 2: '2017 PM Peak' (FG2: 'PM Peak 2017', Plan 2: 'Network Control Plan 2')
Stage Sequence Diagram

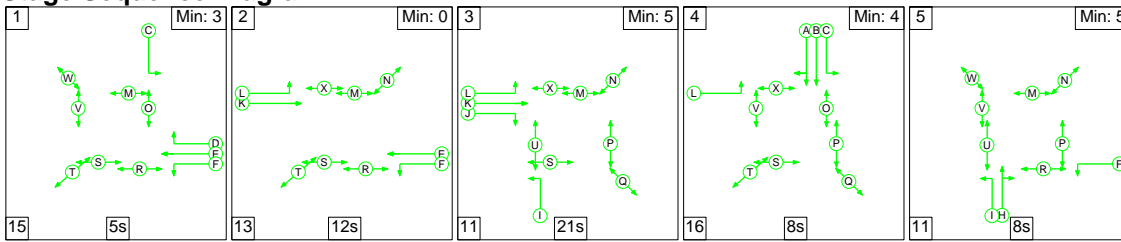

Stage Timings

Stage	1	2	3	4	5
Duration	5	12	21	8	8
Change Point	0	20	45	77	101

Signal Timings Diagram

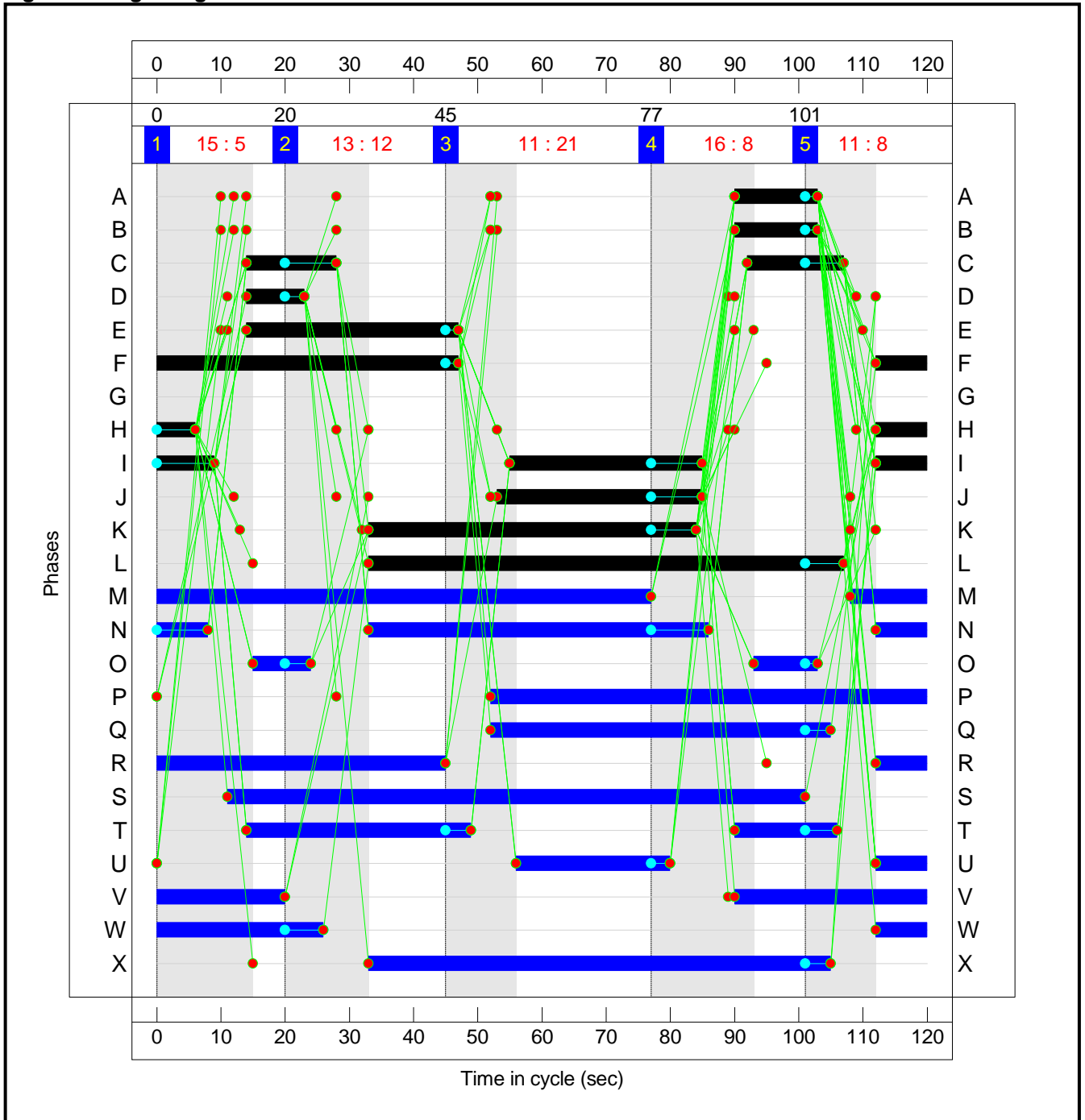

Network Layout Diagram

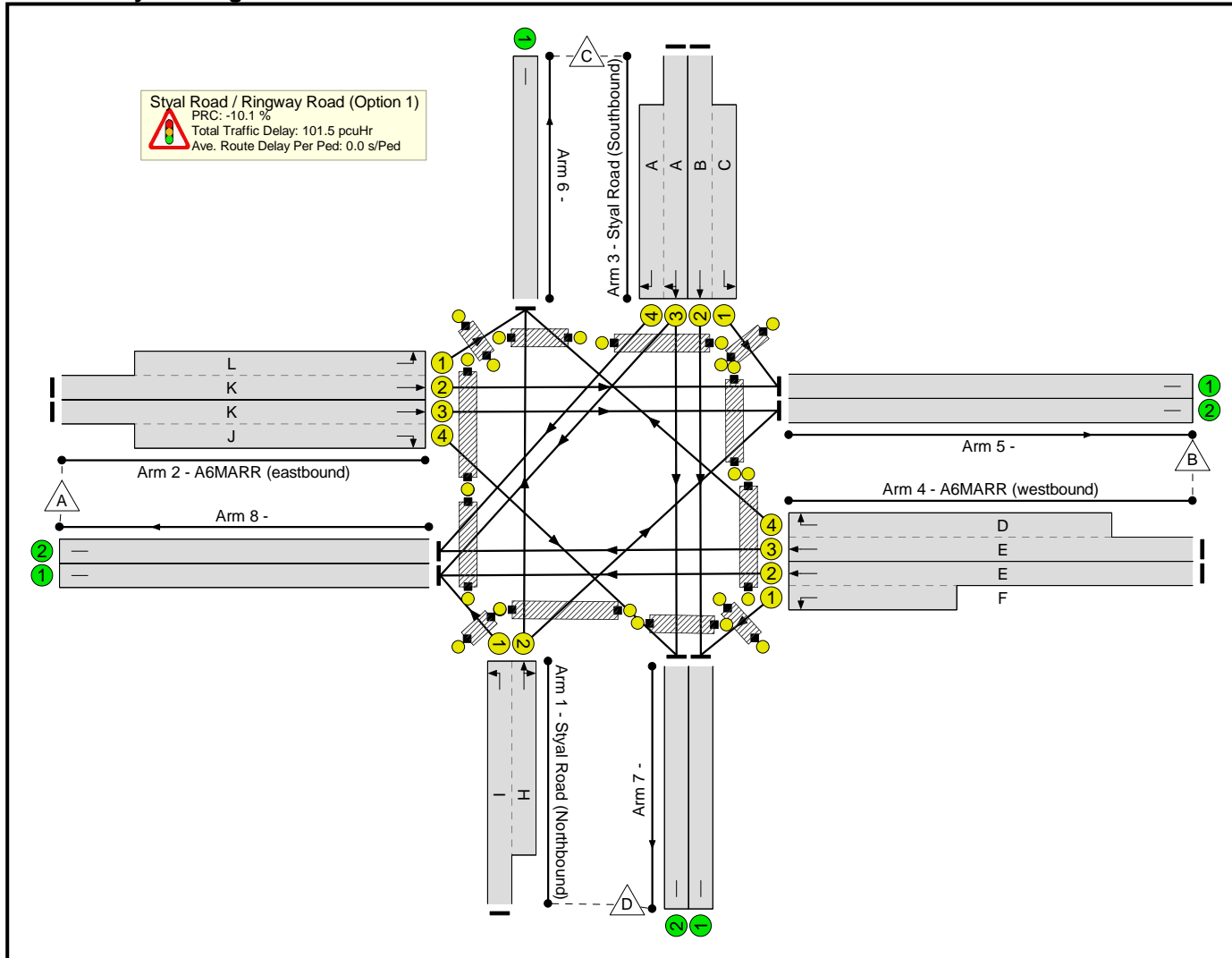

Network Results

Item	Lane Description	Lane Type	Controller Stream	Position In Filtered Route	Full Phase	Arrow Phase	Num Greens	Total Green (s)	Arrow Green (s)	Demand Flow (pcu)	Sat Flow (pcu/Hr)	Capacity (pcu)	Deg Sat (%)
Network: Styal Rd/A6MARR	-	-	N/A	-	-		-	-	-	-	-	-	99.1%
Styal Road / Ringway Road (Option 1)	-	-	N/A	-	-		-	-	-	-	-	-	99.1%
1/1+1/2	Styal Road (Northbound) Right Ahead Left	U	N/A	N/A	I H		2:1	47:14	-	914	2010:2001	821+250	81.5 : 98.0%
2/2+2/1	A6MARR (eastbound) Ahead Left	U	N/A	N/A	K L		1	51:74	-	1241	1975:1995	856+499	98.7 : 79.4%
2/3+2/4	A6MARR (eastbound) Ahead Right	U	N/A	N/A	K J		1	51:32	-	1372	2115:1847	915+508	95.6 : 97.8%
3/2+3/1	Styal Road (Southbound) Left Ahead	U	N/A	N/A	B C		1:2	13:29	-	623	1975:2008	110+519	99.1 : 99.1%
3/3+3/4	Styal Road (Southbound) Ahead Right	U	N/A	N/A	A		1	13	-	412	1910:1923	223+224	92.0 : 92.3%
4/2+4/1	A6MARR (westbound) Left Ahead	U	N/A	N/A	E F		1	33:55	-	559	1995:1983	541+71	91.2 : 91.2%
4/3+4/4	A6MARR (westbound) Right Ahead	U	N/A	N/A	E D		1	33:9	-	725	2135:1895	605+158	94.4 : 97.5%
5/1		U	N/A	N/A	-		-	-	-	1359	Inf	Inf	0.0%
5/2		U	N/A	N/A	-		-	-	-	941	Inf	Inf	0.0%
6/1		U	N/A	N/A	-		-	-	-	729	Inf	Inf	0.0%
7/1		U	N/A	N/A	-		-	-	-	174	Inf	Inf	0.0%
7/2		U	N/A	N/A	-		-	-	-	609	Inf	Inf	0.0%
8/1		U	N/A	N/A	-		-	-	-	1256	Inf	Inf	0.0%

Item	Lane Description	Lane Type	Controller Stream	Position In Filtered Route	Full Phase	Arrow Phase	Num Greens	Total Green (s)	Arrow Green (s)	Demand Flow (pcu)	Sat Flow (pcu/Hr)	Capacity (pcu)	Deg Sat (%)
8/2		U	N/A	N/A	-		-	-	-	778	Inf	Inf	0.0%
Ped Link: P1	Unnamed Ped Link	-	N/A	-	N		2	69	-	0	-	0	0.0%
Ped Link: P2	Unnamed Ped Link	-	N/A	-	O		2	19	-	0	-	0	0.0%
Ped Link: P3	Unnamed Ped Link	-	N/A	-	P		1	68	-	0	-	0	0.0%
Ped Link: P4	Unnamed Ped Link	-	N/A	-	Q		1	53	-	0	-	0	0.0%
Ped Link: P5	Unnamed Ped Link	-	N/A	-	R		1	53	-	0	-	0	0.0%
Ped Link: P6	Unnamed Ped Link	-	N/A	-	S		1	90	-	0	-	0	0.0%
Ped Link: P7	Unnamed Ped Link	-	N/A	-	T		2	51	-	0	-	0	0.0%
Ped Link: P8	Unnamed Ped Link	-	N/A	-	U		2	32	-	0	-	0	0.0%
Ped Link: P9	Unnamed Ped Link	-	N/A	-	V		1	50	-	0	-	0	0.0%
Ped Link: P10	Unnamed Ped Link	-	N/A	-	W		1	34	-	0	-	0	0.0%
Ped Link: P11	Unnamed Ped Link	-	N/A	-	X		1	72	-	0	-	0	0.0%
Ped Link: P12	Unnamed Ped Link	-	N/A	-	M		1	89	-	0	-	0	0.0%

Item	Arriving (pcu)	Leaving (pcu)	Turners In Gaps (pcu)	Turners When Unopposed (pcu)	Turners In Intergreen (pcu)	Uniform Delay (pcuHr)	Rand + Oversat Delay (pcuHr)	Storage Area Uniform Delay (pcuHr)	Total Delay (pcuHr)	Av. Delay Per PCU (s/pcu)	Max. Back of Uniform Queue (pcu)	Rand + Oversat Queue (pcu)	Mean Max Queue (pcu)
Network: Styal Rd/A6MARR	-	-	0	0	0	56.7	44.8	0.0	101.5	-	-	-	-
Styal Road / Ringway Road (Option 1)	-	-	0	0	0	56.7	44.8	0.0	101.5	-	-	-	-
1/1+1/2	914	914	-	-	-	6.7	2.8	-	9.5	37.5	12.5	2.8	15.3
2/2+2/1	1241	1241	-	-	-	9.1	5.0	-	14.1	40.9	27.7	5.0	32.7
2/3+2/4	1372	1372	-	-	-	13.9	9.7	-	23.7	62.2	28.0	9.7	37.7
3/2+3/1	623	623	-	-	-	5.9	11.1	-	17.0	98.4	11.3	11.1	22.4
3/3+3/4	412	412	-	-	-	6.0	4.6	-	10.6	93.0	6.8	4.6	11.4
4/2+4/1	559	559	-	-	-	6.0	4.5	-	10.5	67.6	16.6	4.5	21.1
4/3+4/4	725	725	-	-	-	9.0	7.0	-	16.0	79.5	18.6	7.0	25.6
5/1	1359	1359	-	-	-	0.0	0.0	-	0.0	0.0	0.0	0.0	0.0
5/2	941	941	-	-	-	0.0	0.0	-	0.0	0.0	0.0	0.0	0.0
6/1	729	729	-	-	-	0.0	0.0	-	0.0	0.0	0.0	0.0	0.0
7/1	174	174	-	-	-	0.0	0.0	-	0.0	0.0	0.0	0.0	0.0
7/2	609	609	-	-	-	0.0	0.0	-	0.0	0.0	0.0	0.0	0.0
8/1	1256	1256	-	-	-	0.0	0.0	-	0.0	0.0	0.0	0.0	0.0
8/2	778	778	-	-	-	0.0	0.0	-	0.0	0.0	0.0	0.0	0.0
Ped Link: P1	0	0	-	-	-	-	-	-	-	-	-	-	-
Ped Link: P2	0	0	-	-	-	-	-	-	-	-	-	-	-
Ped Link: P3	0	0	-	-	-	-	-	-	-	-	-	-	-
Ped Link: P4	0	0	-	-	-	-	-	-	-	-	-	-	-

Item	Arriving (pcu)	Leaving (pcu)	Turners In Gaps (pcu)	Turners When Unopposed (pcu)	Turners In Intergreen (pcu)	Uniform Delay (pcuHr)	Rand + Oversat Delay (pcuHr)	Storage Area Uniform Delay (pcuHr)	Total Delay (pcuHr)	Av. Delay Per PCU (s/pcu)	Max. Back of Uniform Queue (pcu)	Rand + Oversat Queue (pcu)	Mean Max Queue (pcu)
Ped Link: P5	0	0	-	-	-	-	-	-	-	-	-	-	-
Ped Link: P6	0	0	-	-	-	-	-	-	-	-	-	-	-
Ped Link: P7	0	0	-	-	-	-	-	-	-	-	-	-	-
Ped Link: P8	0	0	-	-	-	-	-	-	-	-	-	-	-
Ped Link: P9	0	0	-	-	-	-	-	-	-	-	-	-	-
Ped Link: P10	0	0	-	-	-	-	-	-	-	-	-	-	-
Ped Link: P11	0	0	-	-	-	-	-	-	-	-	-	-	-
Ped Link: P12	0	0	-	-	-	-	-	-	-	-	-	-	-
C1			PRC for Signalled Lanes (%):		-10.1	Total Delay for Signalled Lanes (pcuHr):		101.47	Cycle Time (s): 120				
			PRC Over All Lanes (%):		-10.1	Total Delay Over All Lanes(pcuHr):		101.47					

Appendix G

A6MARR Public Rights of Way



A6 to Manchester Airport Relief Road Public Rights of Way



September 2013 (23/09/13)



A6 to Manchester Airport Relief Road

Public Rights of Way ***23/09/2013***

Document History

			DOCUMENT REF: 1007/6.15.2/183			
Version	Purpose Description	Originated	Checked	Reviewed	Authorised	Date
1	June 2013 Working Draft	JT				
2	July 2013 Revised Draft	E Brough				
3	September 2013 Final	E Brough				
4						
5						

Contents

Section

1. **Project Background**

Purpose of this document
The A6 to Manchester Airport Relief Road Scheme

2. **Existing Situation**

Overview

3. **Identification of Proposals**

4. **Consultation and Investigation**

5. **Option Analysis Results of Consultation with Landowners**

6. **Route Upgrades to be promoted subsequent to the Road Scheme**

7. **Future Aspirational Routes to be kept under Review**

8. **Conclusions and Way Forward**

Appendices

Appendix A – PRow Plans showing routes proposed to be improved as part of the A6MARR Scheme

Appendix B – PRow Plans showing routes to be improved in the future if the opportunity arises

1. Project Background

Purpose of this document

- 1.1 This document presents the A6 to Manchester Airport Relief Road preferred package of upgrades to the Public Rights of Way Network in Stockport and Cheshire East.
- 1.2 The A6 to Manchester Airport Relief Road will improve surface access to Manchester Airport and provide better connectivity along the south Manchester corridor, to assist Greater Manchester and Cheshire East in meeting their aspirations for economic growth. It directly supports the Government's objective to provide major transport infrastructure that will deliver economic growth, a fact acknowledged by the announcement on prioritisation for funding in the Chancellor's Autumn Statement in November 2011. The scheme will provide congestion relief to local communities and generate wider benefits to business through improved journey time reliability on the local and strategic highway network.
- 1.3 The scheme is an integral component of the wider South East Manchester Multi-Modal Strategy (SEMMS), which has delivered benefits to local communities across south-east Manchester through a range of public transport and sustainable transport measures over the past ten years. It is widely recognised that the A6 to Manchester Airport Relief Road is critical to delivering the long-term objectives of the SEMMS strategy, and to meet national objectives for growth, employment and connectivity.

The A6 to Manchester Airport Relief Road Scheme

Scheme Description

- 1.4 The A6 to Manchester Airport Relief Road Scheme will provide 10 kilometres of predominantly new 2-lane dual carriageway on an east-west route from the A6 near Hazel Grove (south east Stockport), via the 4 kilometres of existing A555 to Manchester Airport and the link road to the M56. The scheme bypasses heavily-congested district and local centres, including Bramhall, Cheadle Hulme, Hazel Grove, Handforth, Poynton, Wythenshawe, Gatley and Heald Green. It will provide much-needed connectivity for key strategic routes into the North West and to Manchester Airport, including traffic from the A6, A523 and A34 – all of which are key routes for business, leisure travel and freight from Cheshire, Derbyshire, Staffordshire, Yorkshire and beyond.
- 1.5 The scheme incorporates seven new and four improved junctions, four railway crossings, a parallel shared cycle/pedestrian path and priority for public transport, and will provide a step-change in the allocation of existing road space in favour of sustainable modes of transport, thereby improving access for public transport, pedestrians and cyclists, and improving the quality of life in residential areas along the south Manchester corridor.
- 1.6 The majority of benefits will accrue to road users and local residents through improved access to centres of employment, commerce and leisure facilities. A package of complementary measures will maximise the scope of potential benefits by making the most efficient use of road space where there are forecast reductions in car traffic. Such measures could include widening pavements, provision of bus lanes and general environmental enhancements for non-road users. These measures will prevent available road space from simply filling up with more cars. Similarly, a package of mitigation measures will contribute to overall value for money by limiting any negative impacts resulting from the scheme. Together, the complementary and mitigation measures will help secure substantial environmental, safety and social benefits.

What the scheme includes

1.7 The A6 to Manchester Airport Relief Road scheme comprises:

- **The Relief Road**, which is a broadly east-west route from the A6 near Hazel Grove (south east from Stockport) to Manchester Airport and the link road to the M56, incorporating ten new junctions and four railway crossings;
- **Provision of a segregated cycle/pedestrian** route adjacent to the new road and existing length of the A555, providing a new orbital link for the Strategic Cycle/ Pedestrian Network;
- **A package of complementary measures** in accordance with the SEMMMS Strategy that will maximise the scope of benefits by making the most efficient use of road space where there are forecast reductions in car traffic. These measures will prevent available road space from simply filling up with more cars; and
- **A package of mitigation measures** will contribute to overall value for money by limiting any negative impacts resulting from the scheme, including environmental and construction engineering mitigation to minimise the effect of the road on local communities and surrounding habitats.

Limiting the impact of transport on the environment

1.8 The proposed relief road will contribute to a strategy that is focused on securing environmental benefits as an integral part of economic and social objectives. Implementation of the proposed scheme will involve specific environmental impacts within the proposed highway corridor between the A6 and the Airport – some of which will require mitigation to offset any adverse effect. A comprehensive assessment of the environmental impacts has been undertaken to show where the scheme will bring benefits, and also to identify those areas where mitigation may be required. The main findings from the assessment included:

- **Improved rights of way and access to the countryside** through the provision of safe crossing points and a segregated pedestrian and bridleways on A555 existing network.
- **Improved access on existing rights of way** near the road by the implementation of higher level rights for instance upgrading a footpath to a bridleway.

2. Existing Situation

Overview

- 2.1 Public rights for routes shown on the definitive map and statement for Stockport and for Cheshire East Councils are classed as:
- **Footpath:** A public right of way on foot.
 - **Bridleway:** A public right of way on foot, on horseback which can be used by cyclists. Cyclists must give way to both walkers and horse riders.
 - **Restricted Byways:** A public right of way on foot, on horseback, for cycles and for horse drawn carriages.
 - **Byway Open to All Traffic (BOAT):** A public right of way on foot, on horseback, for cyclists and for all vehicles.
- 2.2 Typically users of a public right of way may take 'usual accompaniments' with them. These include prams, pushchairs, wheelchairs and dogs. A bicycle is not a 'usual accompaniments' and might be considered an act of trespass.
- 2.3 With the aim of overall connectivity and in keeping with the rationale of the main A6 to Manchester Scheme Relief Road scheme design consideration has also been given to the creation of Cycle Track status along some potential routes, defined as:
- **Cycle Track:** A way over which the public have a right of way on pedal cycles with or without a right of way on foot, other than pedal cycles which are classed as motor vehicles as in the Road Traffic Act 1972.

Creation of new public rights of way

- 2.4 A footpath, bridleway or restricted byway can be created by one of the following means.

Dedication

- 2.5 In England and Wales, a footpath, bridleway or restricted byway may be expressly dedicated by the owner as a public right of way. Furthermore, unchallenged use by the public, as of right, for at least 20 years, may give rise to a presumption of dedication under Section 31 of the Highways Act 1980. A presumption of dedication may arise under common law after any appropriate period of time, by way of a presumed deed that has been lost; known as the doctrine of "modern lost grant". Paths created by express dedication since 1949 are not automatically maintainable at public expense as a result of s.49 National Parks and Access to the Countryside Act 1949.

Public Path Creation Agreement

- 2.6 Section 25 of the Highways Act 1980 allows a local authority (that is, a district or county council, or a unitary authority) to enter into an agreement (known as a 'Public Path Creation Agreement') with a relevant landowner to create a footpath or bridleway over land in their area. The local authority has to consult any other local authority in whose area the path will be, but does not have to consult wider. There is no provision for anyone else to be consulted or to object. The agreement must be advertised in the local paper, and the route is automatically maintainable at the public expense.

Agreement between a parish council and landowner

- 2.7 Section 30 of the Highways Act 1980 allows a parish council (community council in Wales) to enter into an agreement with a relevant landowner to create a footpath, bridleway or restricted byway over land in their area or in an adjacent parish. The parish council is under no obligation to consult anyone. All they have to do is reach an agreement with the landowner. There is no provision for anyone else to be consulted or to object. The path is not automatically maintainable at public expense.

Public Path Creation Order

- 2.8 Section 26 of the Highways Act 1980 allows a local authority (that is, a district or county council, or a unitary authority) to make an order to create a footpath or bridleway over land in their area. If there are no objections, the local authority can confirm the Order themselves, so bringing the path into effect. However, where objections have been made, the Order will need to be considered by an inspector from the Planning Inspectorate. Depending on the number and nature of the objections, he may consider the Order after an exchange of written representations between the authority and the objectors, after holding a hearing, or after a public local inquiry.

Highway works authority

- 2.9 Section 228 of the Highways Act 1980 is mainly used by the street works authority (County Council or unitary authority) to declare a street to be a highway maintainable at public expense. The street works authority has to perform works on the route. Such street works need only be appropriate to the type of highway to which the notice relates. So for a potential bridleway, if the grass is cut, or a hedge cut back, this could constitute street works for the purpose of this section, so enabling it to be used. The authority then place s.228 "Adoption of Streets" notices at each end of the route. Only the owner of a street (or if more than one, the majority of the owners) has the power to object. If there is an objection, the street works authority can either discontinue, or it can go to the magistrates court. A path created by this method will be maintainable at the public expense.

Cycle track Creation

- 2.10 Cycle tracks away from roads can be converted from footpaths under the Cycle Tracks Act 1984. A landowner's permission for the conversion is required if the track passes over farmland (Section 3 (2) of the act). Walking rights are preserved along cycle tracks created under the Cycle Tracks Act. However they cease to be public footpaths. As such, cycle tracks are a form of highway that is not a definitive public right of way, which means that neither the track nor the previous footpath can be shown on the definitive map. If in the future the Cycle Track Order is revoked, the public footpath is reinstated and will reappear on the definitive map.

Existing Public Rights of Way Network

- 2.11 All existing definitive Public Rights of Way (PRoW) effected by the relief road have been identified and considered for potential improvement and/or upgrade to facilitate improved access throughout the Stockport and Cheshire East areas and in the vicinity of the proposed A6 to Manchester Airport Relief Road scheme.

2.12 Each PRoW and the existing status of the route is summarised in Table1 below:

Table 1 - Public Rights of Way Near or Affected by the proposed Relief Road Existing Status

Route No.	Status
Hazel Grove & Bramhall 77HGB	Footpath
Hazel Grove & Bramhall 65HGB	Footpath - Access Road
Poynton-with-Worth FP62/2	Footpath
Poynton-with-Worth FP15/1	Footpath
Poynton-with-Worth FP64/1	Footpath
Poynton-with-Worth FP3/2 NW	Footpath
Poynton-with-Worth FP3/1 SE	Footpath
Poynton-with-Worth FP37/1 N	Footpath
Poynton-with-Worth FP37/1 S	Footpath
Poynton-with-Worth FP31 N	Footpath
Poynton-with-Worth FP31 S	Footpath
Poynton-with-Worth FP21 S	Footpath
Poynton-with-Worth RB39/1 to RB39/6	Restricted Byway
Hazel Grove & Bramhall 19HGB	Footpath
Hazel Grove & Bramhall 16HGB	Footpath
Hazel Grove & Bramhall 17HGB	Footpath
Hazel Grove & Bramhall 14(a)HGB	Footpath
Cheadle and Gatley 16CG	Footpath
Cheadle and Gatley 50CG	Footpath
Wilmslow FP140/1	Footpath
Cheadle and Gatley 42(a)CG	Footpath - Access Road
Cheadle and Gatley 42CG	Footpath-Access Road
Cheadle and Gatley 38CG	Footpath
Wilmslow FP80	Footpath
Wilmslow FP143	Footpath
Cheadle and Gatley 33CG	Footpath
Wilmslow FP7 NE	Footpath
Cheadle and Gatley 107CG	Footpath

3. Identification of Proposals

Aspirational Network Improvements

3.1 Following initial assessment of all PRoW routes, early stage aspirations were identified based on a number of influencing factors, these included:

- Existing route status
- Standard of route, topography and alignment.
- Connectivity of route – to surrounding links and to main scheme proposals
- User demand
- Previous user group consultation
- Expected benefit from upgrade
- Preliminary cost of upgrade
- Input and detailed discussion with internal representatives of Highway Design, Public Rights of Way and Cycling.

3.2 Table 2 below provides information on the proposed changes to the PRoW network.

Table 2 – Public Rights of Way Proposed Upgrades

Footpath No.	Extents	Current Status	Proposed Status
Hazel Grove & Bramhall 77HGB	From Sandown Lane to 65HGB	Footpath	Cycle Track
Hazel Grove & Bramhall 65HGB	Hazel Grove Golf Course to A6	Footpath - Access Road	Cycle Track
Poynton-with-Worth FP62/2	From connection of 109HGB, 76HGB and FP62/2 to FP64C/1	Footpath	Bridleway
Poynton-with-Worth FP15/1	From FP62/2 to FP64C/1	Footpath	Bridleway
Poynton-with-Worth FP64/1	From FP64C/1 to Towers Road	Footpath	Bridleway
Poynton-with-Worth FP3/2 NW	Scheme to Woodford Road	Footpath	Cycle Track
Poynton-with-Worth FP3/1 SE	Scheme to London Road North	Footpath	Bridleway
Poynton-with-Worth FP37/1 S	Scheme to Woodford Road	Footpath	Bridleway
Poynton-with-Worth FP31 N	Scheme to Woodford Road	Footpath	Bridleway
Poynton-with-Worth FP31 S	Scheme to RB39	Footpath	Bridleway
Hazel Grove Bramhall 19HGB	From Woodford Road to Scheme	Footpath	Bridleway

Footpath No.	Extents	Current Status	Proposed Status
Hazel Grove & Bramhall 16HGB	From proposed scheme to 17HGB	Footpath	Bridleway
Hazel Grove & Bramhall 17HGB	16HGB to Adelaide Road	Footpath	Bridleway
Cheadle and Gatley 16CG	From Moor Lane to Highfield Parkway	Footpath	Bridleway
Cheadle and Gatley 50CG	Along proposed scheme to FP140/1	Footpath	Cycle Track
Cheadle and Gatley 50CG	From Proposed Scheme to hall Moss Lane along Spath Lane East	Footpath	Bridleway
Wilmslow FP140/1	From 50CG to Spath Lane	Footpath	Cycle Track
Cheadle and Gatley 42(a)CG	From FP140/1 to 42CG	Footpath - Access Road	Bridleway
Cheadle and Gatley 42CG	From 42(a)CG to 38CG	Footpath-Access Road	Bridleway
Cheadle and Gatley 38CG	From 42CG to Longsight Lane	Footpath	Bridleway
Wilmslow FP80	From 42(a)CG to Earl Road	Footpath	Bridleway
Wilmslow FP143	From Tatton Road to 33CG	Footpath	Bridleway
Cheadle and Gatley 33CG	From FP143 to Stanley Road	Footpath	Bridleway
Wilmslow FP7 NE	From 107CG to Scheme	Footpath	Cycle Track
Cheadle and Gatley 107CG	From FP7 To Bolshaw Road	Footpath	Cycle Track
Wilmslow FP119		Footpath	Bridleway

3.3 Preliminary analysis led to the identification of further options to improve connectivity in the Cheadle Hulme area of Stockport by promoting a new PRow Bridleway along Longsight Lane between Stanley Road and Spath Lane as shown in the appended **Table 2.1** below:

Table 2.1 – Public Rights of Way Proposed Upgrades

Longsight Lane	From 38CG to Stanley Road	Private Road	Bridleway
----------------	---------------------------	--------------	-----------

3.4 Other proposals to improve the linkages for sustainable modes were:

- An on-highway (A6) link to the Middlewood Way to complete a cycle route from the Manchester Airport on the new cycle route to Marple and other urban areas accessed by the Middlewood Way. An off-carriageway connection to Towers Road from the Macclesfield Road Junction to complete the link from Hazel Grove to Poynton for Cyclist.
- Wider Ladybrook Valley improvements to further support the usefulness of the network improvements in the area.
- Improved off carriageway linkage on Chester Road to give connection for residential area to proposed bridleway 'spur' on Chester Road Junction. Most likely option to be an uncontrolled crossing island suitable for cyclists and pedestrians.
- Improved off or on road cycle linkages between Woodford Road Junction and Jenny Lane which is a quieter route for less experienced cyclists.
- Improved highway connection is required for St James' Secondary between Longsight Lane and A34 pedestrian and cyclist improvements.
- Possible link from Disley through Lyme Park to to High Lane and potentially the Middlewood Way, Macclesfield canal and Poynton.
- New link from path in to Albany Road Bramhall towards Queensgate School.

4. Consultation and Investigation

Landowner Consultation

Each Local Highway Authority has the power to promote a change to an existing right of way, however, the statutory process to follow allows for objections to be raised as part of a formal public consultation process. In accordance with the Council's rationale to create minimum disruption to landowners and residents of any affected parcels of land, a main driver towards the promotion of a change to the network is the support, or lack of from Landowners and tenants of each land owner where an existing route passes.

- 4.1 The A6MARR Project Team holds correspondence details of a number of previously contacted landowners and tenants on current information systems. This system was interrogated to produce a list of all directly affected landowners whose land could be affected by a change to an existing PRow.
- 4.2 Interrogation of the database led to the identification of 22 Individual or Company Landowners, some representing a number of different PRow. A further 35 individual landowners were identified through additional land registry searches.
- 4.3 Landowners were initially contacted via both letter and email correspondence where applicable to arrange meetings with each effected landowner to discuss the existing network and any issues over its use, the potential impact of and any associated support towards the proposed change in status of the Right of Way across parts of their land.
- 4.4 Where difficulties arose in arranged direct meetings with an officer of the Council, electronic correspondence was maintained to continue the discussions over the current network and its proposed future use.
- 4.5 Where no contact was made following multiple efforts to contact individuals or company landowners, a decision was taken on a lack of support towards a proposed change to the parts of the network across their land.
- 4.6 In order for a proposed change or upgrade to be taken forward all landowners affected by the particular route must be in agreement and supportive of the proposed changes or the change must be of particular importance to the delivery of the South East Manchester Multi-Modal Strategy through the provision of sustainable transport links which maximise the benefits derived from the road scheme delivery.

Meetings and Correspondence

- 4.7 Where possible, site meetings were held with Landowners, tenants and/or their representatives throughout the months of February to May 2013 to further determine the scope for upgrades and improvements to the PRow Network.
- 4.8 Direct correspondence and continued liaison with landowners allowed a detailed understanding of the more locally prevalent issues to be built up and to qualify previously unknown issues with specific background and details of land ownership, land condition, local access requirements and historical planning information that also contributed to the determination of a preferred package of network upgrades.
- 4.9 The outcome of direct correspondence throughout this period allowed for the final design of a package of network improvements as outlined in the following sections of this report.

5. Option Analysis Results of Consultation with Landowners

5.1 Following substantial landowner consultation the initial option assessment of potential improvements has been filtered to reflect the results of the landowner correspondence.

5.2 **Table 3** below shows the PRoW upgrades that have been provisionally agreed with the directly affected landowners subject to minor details to be agreed. For the purpose of reporting it is assumed at this stage that such agreements can be finalised without detriment to the current supported status.

Table 3 – Public Rights of Way Potential Routes with Provisional Landowner Approval.

Footpath No.	Extents	Current Status	Proposed Status	Landowner Response
Poynton-with-Worth FP3/1 SE	Scheme to London Road North	Footpath	Bridleway	Provisional Support for redirected route.
Hazel Grove & Bramhall 19HGB	From Woodford Road to Scheme	Footpath	Cycle Track	Supported by Landowner
Hazel Grove & Bramhall 17HGB	16HGB to Adelaide Road	Footpath	Cycle Track	Supported by Landowner + Subject to 16HGB
Cheadle and Gatley 16CG	From Moor Lane to Highfield Parkway	Footpath	Bridleway	Supported by Landowner
Wilmslow FP80	From 42(a)CG to Earl Road	Footpath	Cycle Track	Supported subject to agreement
Cheadle and Gatley 33CG	From FP143 to Stanley Road	Footpath	Bridleway	Subject to agreement

5.3 **Table 4** below reflects the current position with regard to ongoing consultation with some affected Landowners and their agents. It is considered that subject to further correspondence that there is potential for upgrades to be included within a finalised package of works, subject to additional required correspondence.

Table 4 – Public Rights of Way Potential Routes with Potential Landowner Approval

Footpath No.	Extents	Current Status	Proposed Status	Landowner Response
Hazel Grove & Bramhall 16HGB	From proposed scheme to 17HGB	Footpath	Cycle Track	Provisional Support Offered
Cheadle and Gatley 42(a)CG	From FP140/1 to 42CG	Footpath - Access Road	Bridleway	Negotiating

Footpath No.	Extents	Current Status	Proposed Status	Landowner Response
Cheadle and Gatley 42CG	From 42(a)CG to 38CG	Footpath-Access Road	Bridleway	Negotiating
Longsight Lane	Stanley Road to 38CG	Private Road	Bridleway	Supported by residents
Wilmslow FP119	From Clay Lane RB87 to CEBC/SMBC boundary and in to SMBC	Footpath	Bridleway	Provisional support offered.

5.4 **Table 5** below reflects the PRow proposals that have:

- No Contact/Response from Landowner (single/multiple or part)
- Correspondence highlights a lack of support one or all Landowners
- Further investigatory works (in contact with or without Landowner) have highlighted route issues.

Table 5 – Public Rights of Way Routes Not receiving complete landowner support/ contact.

Footpath No.	Extents	Current Status	Proposed Status	Details
Hazel Grove & Bramhall 77HGB	From Sandown Road to 65HGB	Footpath	Cycle Track	No Contact
Hazel Grove & Bramhall 65HGB	Hazel Grove Golf Course to A6	Footpath - Access Road	Cycle Track	Only 50% of Contact Supportive
Poynton-with-Worth FP62/2	From connection of 109HGB, 76HGB and FP62/2 to FP64/1	Footpath	Bridleway	Not Supported by Landowner
Poynton-with-Worth FP15/1	From Redirected FP62/2 to FP64/1	Footpath	Bridleway	Not Supported by Landowner
Poynton-with-Worth FP64/1	From Junction of FP62 and FP64/1 to Towers Road	Footpath	Bridleway	Not Supported by Landowner
Poynton-with-Worth FP3/2 NW	Scheme to Woodford Road	Footpath	Cycle Track	Not Supported by Landowner+Underlying land issues
Poynton-with-Worth FP37/1 S	Scheme to Woodford Road	Footpath	Bridleway	Not Supported by Landowner
Poynton-with-Worth FP31 N	Scheme to Woodford Road	Footpath	Bridleway	No contact
Poynton-with-Worth FP31 S	Scheme to RB39	Footpath	Bridleway	No Contact

Footpath No.	Extents	Current Status	Proposed Status	Details
Cheadle and Gatley 38CG	From 42CG to Longsight Lane	Footpath	Bridleway	Not supported by Landowner
Longsight Lane	From 38CG to Stanley Road	Private Road	Bridleway	Not Supported by All Residents
Wilmslow FP143	From Tatton Road to 33CG	Footpath	Bridleway	No Contact

6. Route Upgrades to be promoted subsequent to the Road Scheme

6.1 Following a review of the findings after consultation with landowners the following sections are to be pursued for upgrade as part of the scheme based not only on the desires of the local landowners but the wider needs of the public for a network for sustainable modes in relation to the scheme. The Maps showing the routes related to these schemes can be seen in **Appendix A**.

Table 6 - Public Rights of Way Routes it is proposed to upgrade within the road scheme

Footpath No.	Extents	Current Status	Proposed Status	Justification
Poynton-with-Worth FP3/1 SE	Scheme to London Road North	Footpath	Bridleway	Provisional Support for redirected route.
Hazel Grove & Bramhall 19HGB	From Woodford Road to Scheme	Footpath	Bridleway	Supported by Landowner
Hazel Grove & Bramhall 17HGB	16HGB to Adelaide Road including the link to corner of Meadway.	Footpath	Bridleway	Supported by Landowner Subject to 16HGB
Cheadle and Gatley 16CG	From Moor Lane to Highfield Parkway	Footpath	Bridleway	Supported by Landowner
Poynton-with-Worth FP80	From 42(a)CG to Marthall Way	Footpath	Bridleway	Supported subject to agreement
Cheadle and Gatley 33CG	From FP143 to Stanley Road	Footpath	Bridleway	Subject to agreement
Hazel Grove & Bramhall 16HGB	From proposed scheme to 17HGB	Footpath	Bridleway	Provisional Support Offered
Cheadle and Gatley 42(a)CG	From FP140/1 to 42CG	Footpath - Access Road	Bridleway	Negotiating – considered to be a valuable route
Cheadle and Gatley 42CG	From 42(a)CG to 38CG	Footpath- Access Road	Bridleway	Negotiating– considered to be a valuable route
Longsight Lane	Stanley Road to FP38CG	Private Road	Bridleway	Provisionally supported by residents
Wilmslow FP119	From Clay Lane RB87 to CEBC/SMBC boundary and in to SMBC	Footpath	Bridleway	Provisionally supported by residents
Cheadle and Gatley 38CG	From 42CG to Longsight Lane	Footpath	Bridleway	Not supported by Landowner– considered to be a valuable route

Footpath No.	Extents	Current Status	Proposed Status	Justification
Poynton-with-Worth FP37/1 S	Scheme to Woodford Road Lower Park Road	Footpath	Bridleway	Not Supported by Landowner– considered to be a valuable route
Poynton-with-Worth FP31 N	Scheme to Woodford Road	Footpath	Bridleway	Land Subject to CPO
Wilmslow FP143	From Tatton Road to 33CG	Footpath	Bridleway	No Contact– considered to be a valuable route
Hazel Grove & Bramhall 77HGB	From Sandown Road to 65HGB	Footpath	Bridleway	No Contact– considered to be a valuable route
Hazel Grove & Bramhall 65HGB	Hazel Grove Golf Course to A6	Footpath - Access Road	Bridleway	Only 50% of Contact Supportive– considered to be a valuable route

7. Future Aspirational Routes to be kept under Review

7.1 The existing landowners do not support changes to the following routes but they remain long term aspirations if the circumstances of the land use change. The maps showing the routes related to these schemes can be seen in **Appendix B**.

Table 7 – Public Right Of Way Routes that will not be included within the road scheme but have potential for future upgrade.

Footpath No.	Extents	Current Status	Proposed Status
Poynton-with-Worth FP62/2	From connection of 109HGB, 76HGB and FP62/2 to FP64/1	Footpath	Bridleway
Poynton-with-Worth FP64/1	From Junction of FP62 and FP64/1 to Towers Road	Footpath	Bridleway
Poynton-with-Worth FP65 (Towers Road)	Towers Road	Footpath	Bridleway
Wilmslow FP7 (Styal)	South of the scheme	Footpath	Bridleway

7.2 Other improvements to be undertaken as part of supporting works:

- Improved off carriageway linkage on Chester Road to give connection for residential area to proposed bridleway 'spur' on Chester Road Junction. Most likely option to be an uncontrolled crossing island suitable for cyclists and pedestrians.
- Improved highway connection is required for St James' Secondary between Longsight Lane and A34 pedestrian and cyclist improvements. A secondary connection could also be achieved using the PRow to Rushside Road.

8. Conclusions and Way Forward

Summary of Investigations

- 8.1 Following detailed correspondence with directly affect landowners and tenants of land affected by proposed PRow route upgrades, a provisional package of works has been identified. This includes the proposed upgrade of seventeen existing routes, and the discounting of aspirational changes to six of the initial list of proposed upgrades, due primarily to the lack of support by landowners and their tenants.
- 8.2 Support from Landowners and tenants has been used as a primary indicator for continued promotion of a potential route for upgrade or change as it is anticipated that key objections from such going forward would severely impact on the prospects of a proposal being implementable at a later date.
- 8.3 However it should be noted that four of the schemes being taken forward are schemes without support or where no contact has been made. This is in recognition of the importance of securing these routes as part of the wider network.

Considerations to A6 to Manchester Airport Relief Road Scheme Design

- 8.4 Continued liaison with the A6MARR Design Team for the A6MARR scheme design has ensured that any key PRow proposals that could impact on the main scheme design have been incorporated to ensure compatibility with the final main scheme design proposals. This includes ensuring that main scheme traffic-free elements and PRow proposals are as highly integrated as possible.
- 8.5 There are little or no impacts to the emerging scheme design from the package of PRow improvements detailed within this report.

Appendices

Appendix A – PRow Plans showing routes proposed to be improved as part of the A6MARR Scheme

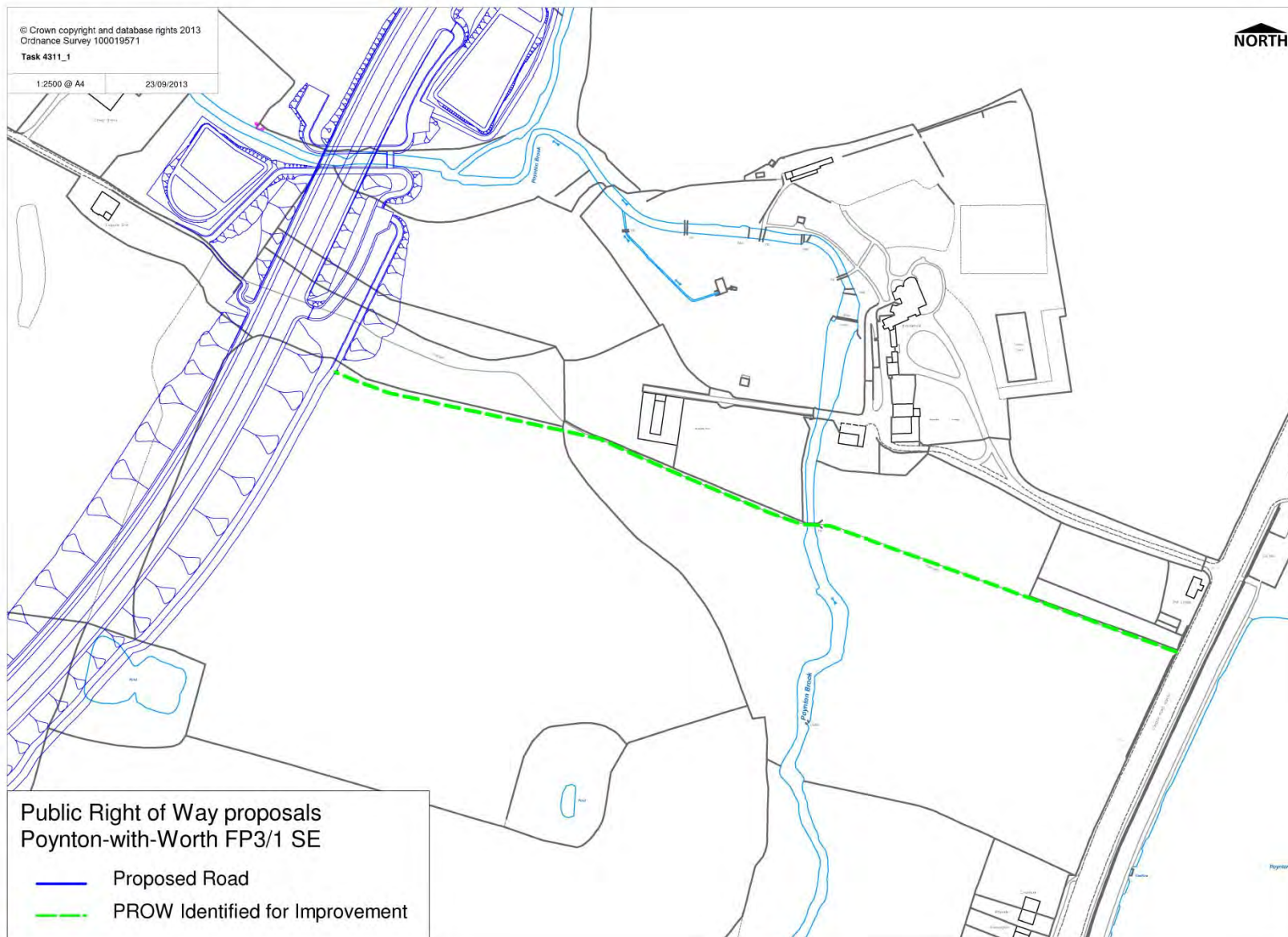

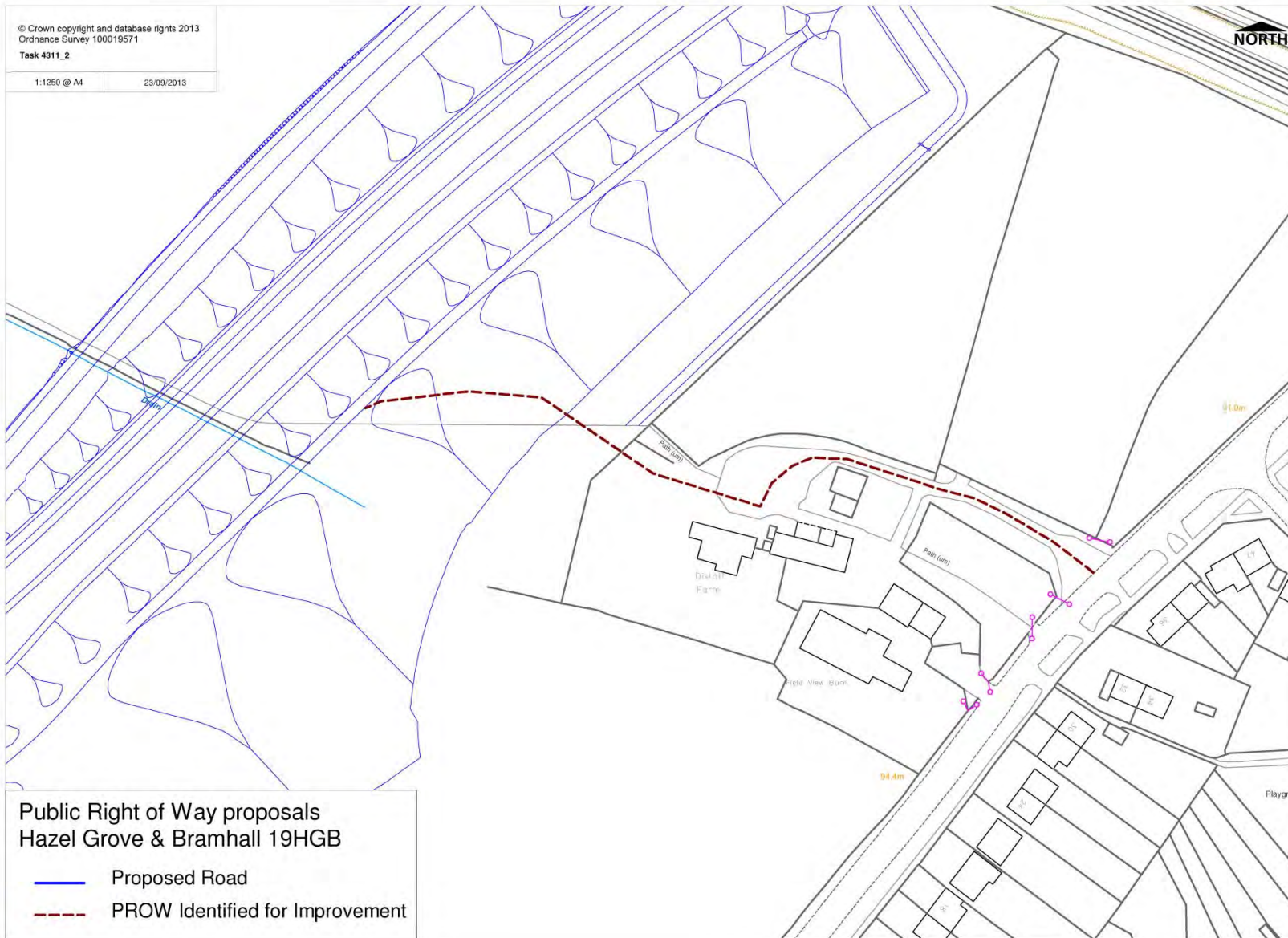



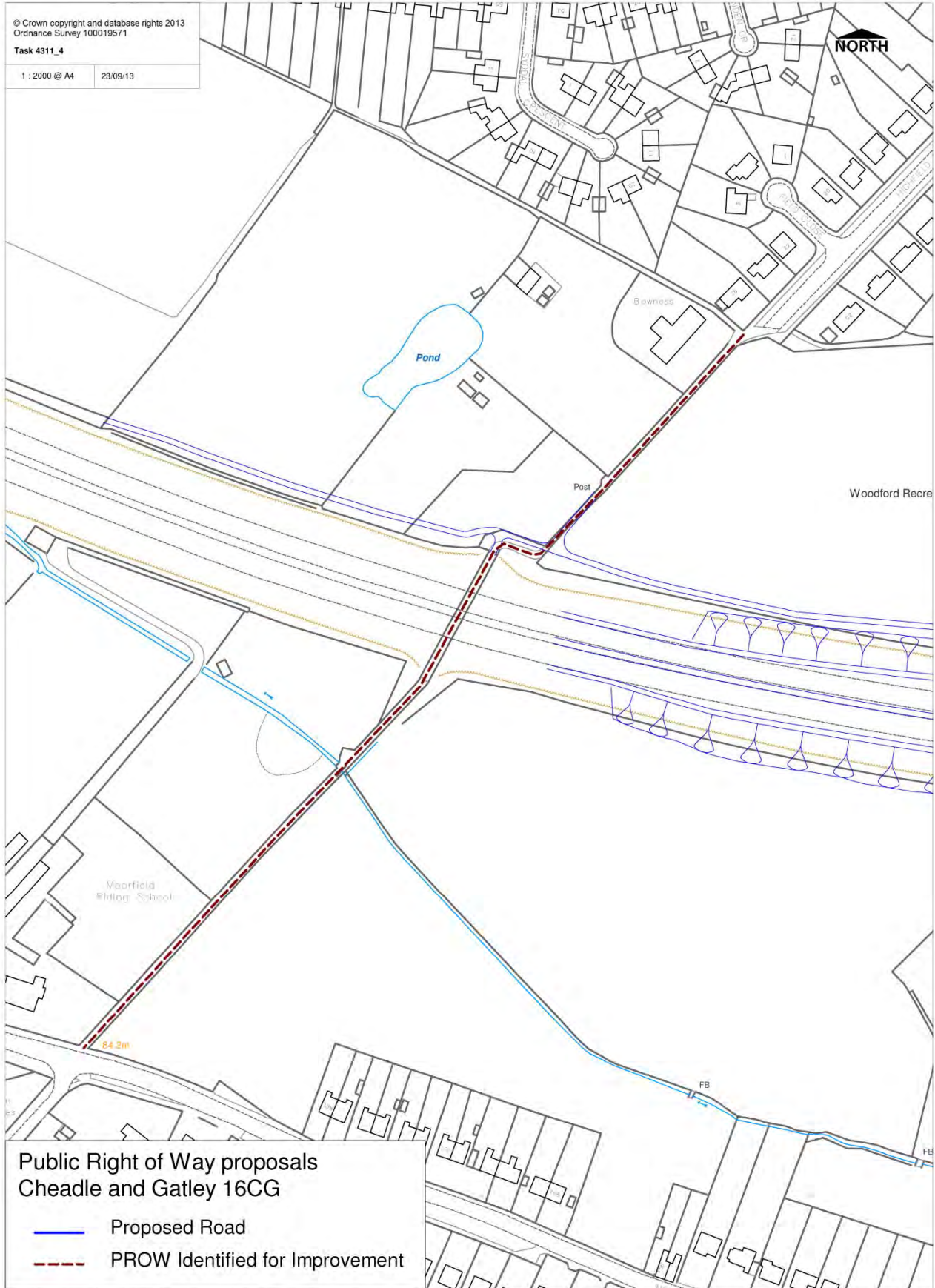

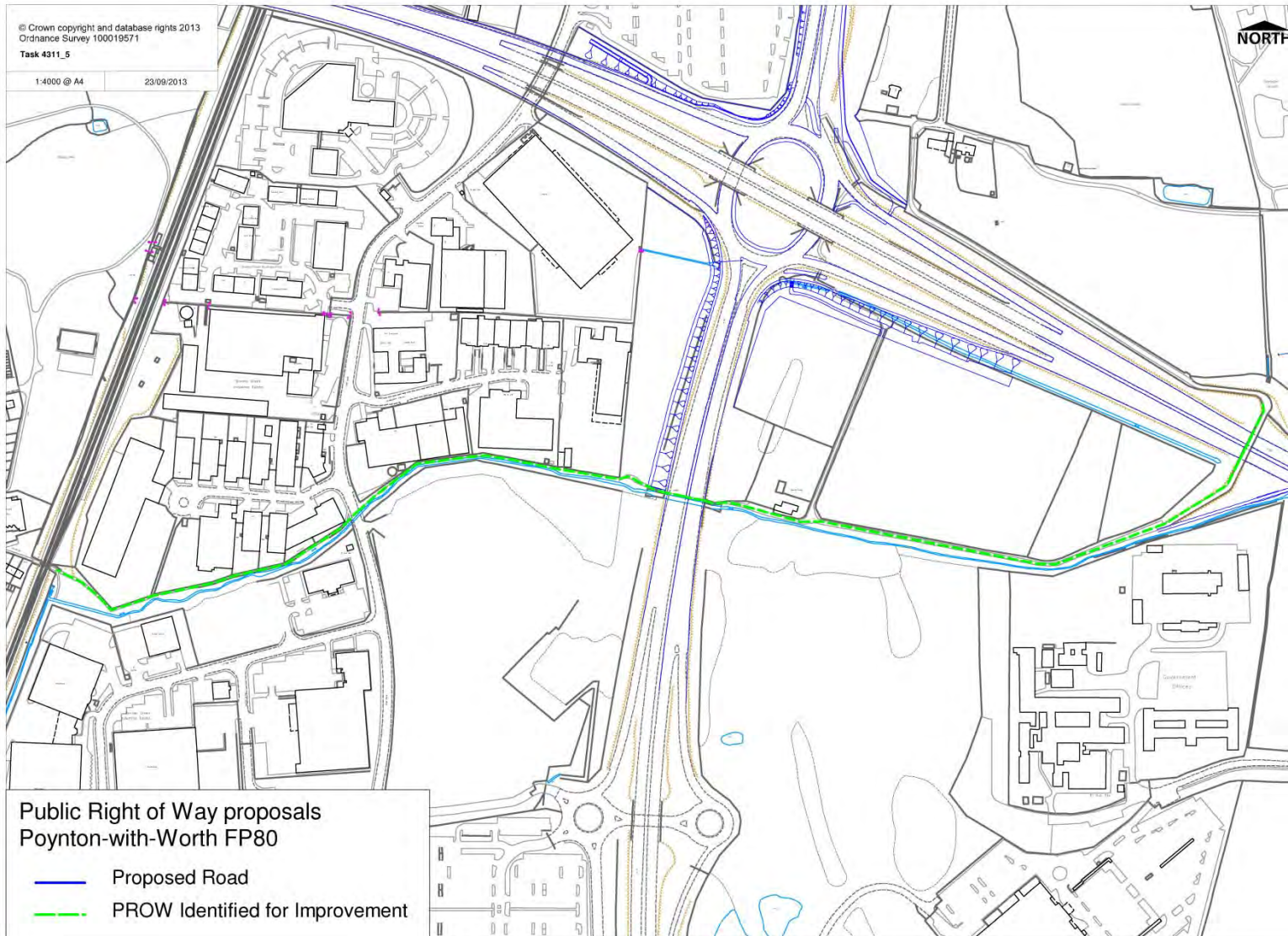



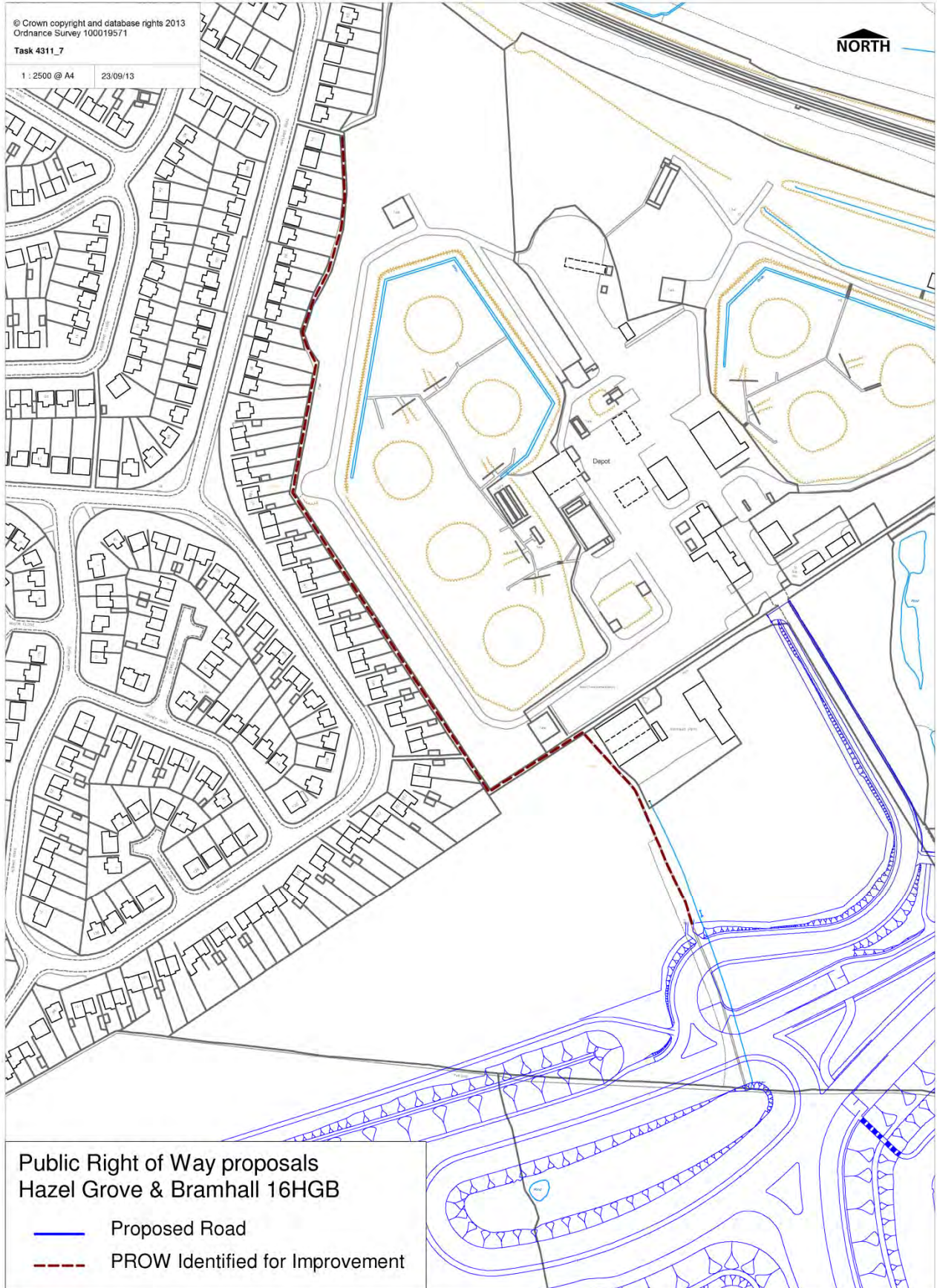

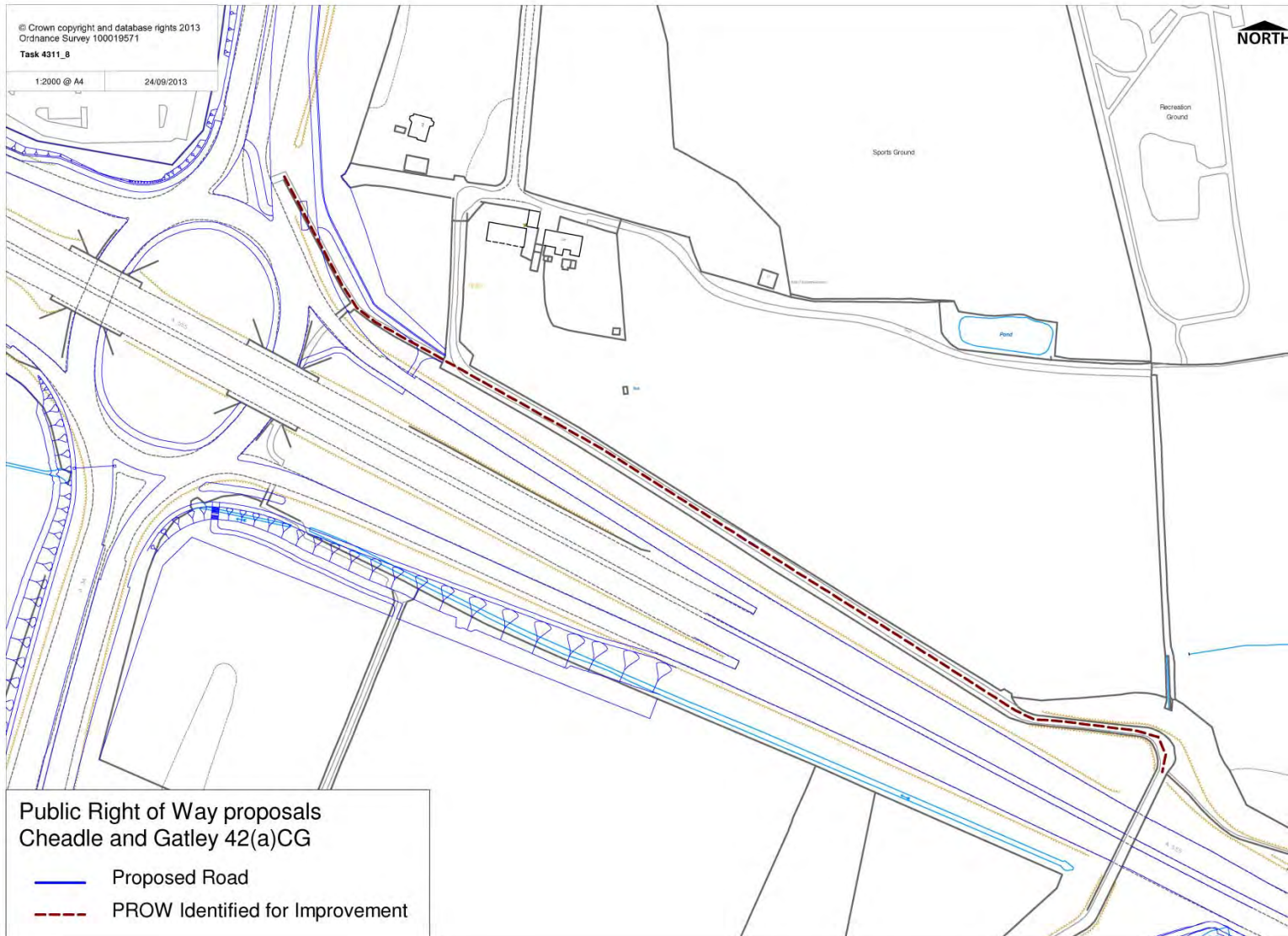

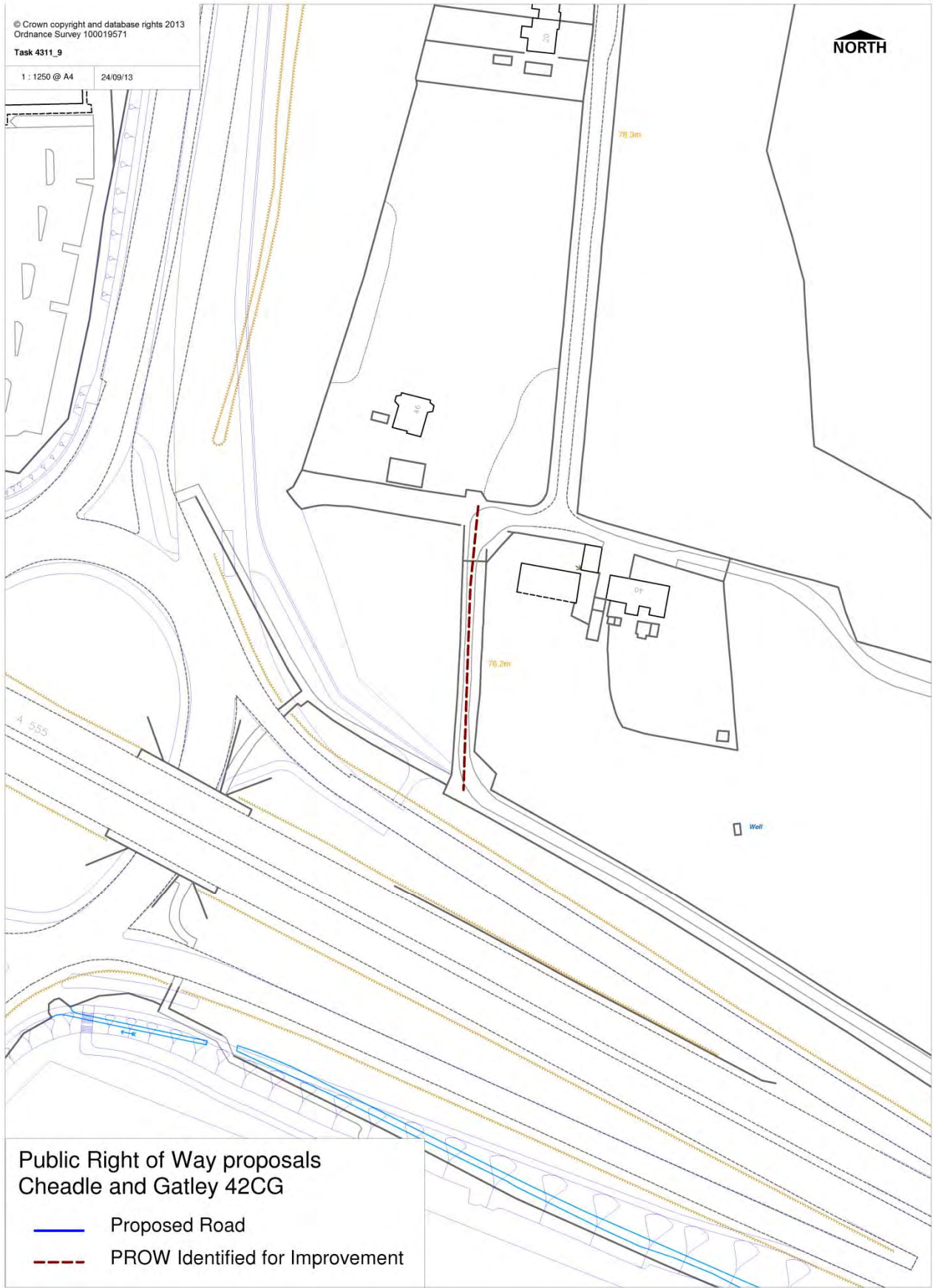

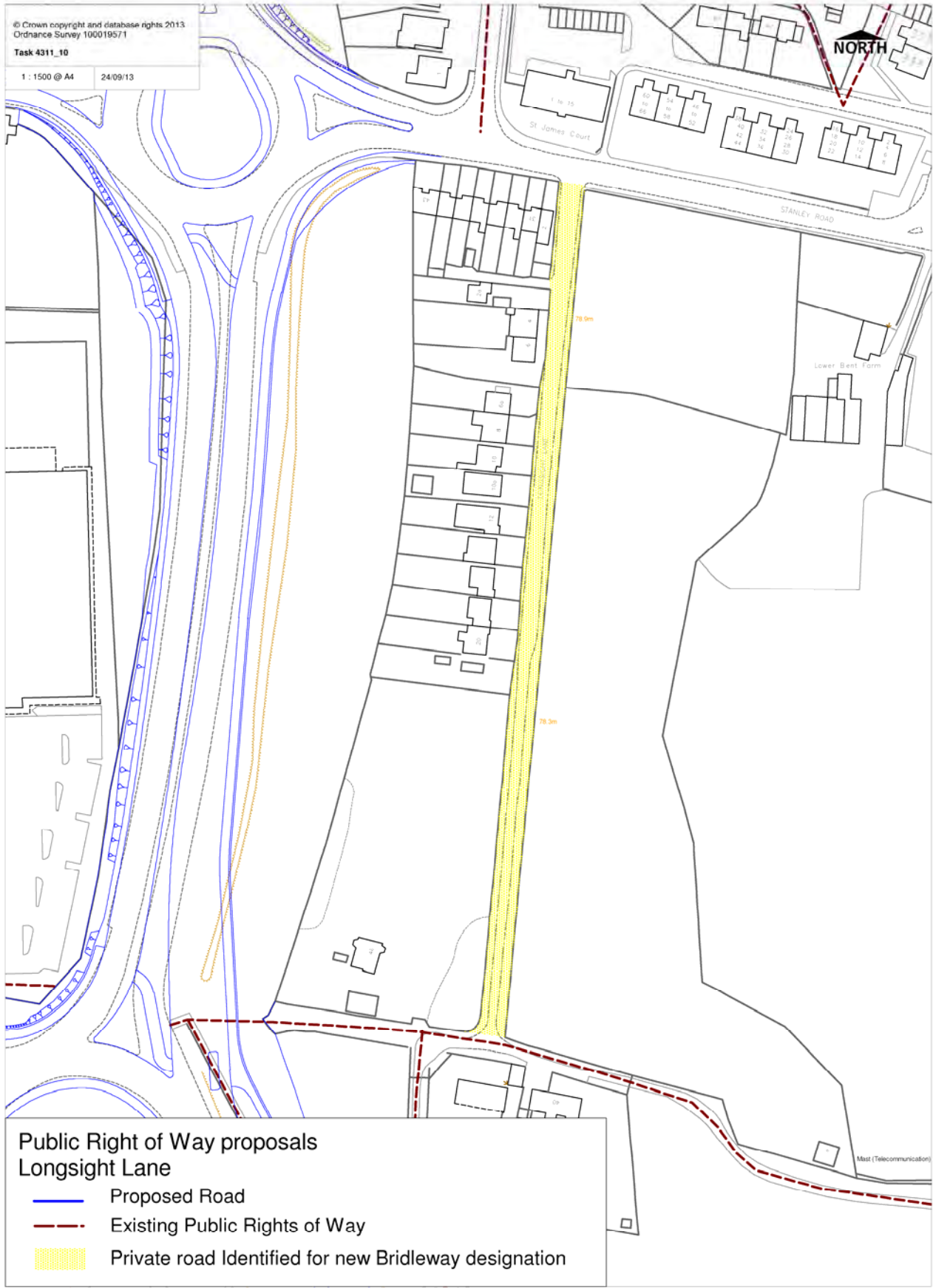

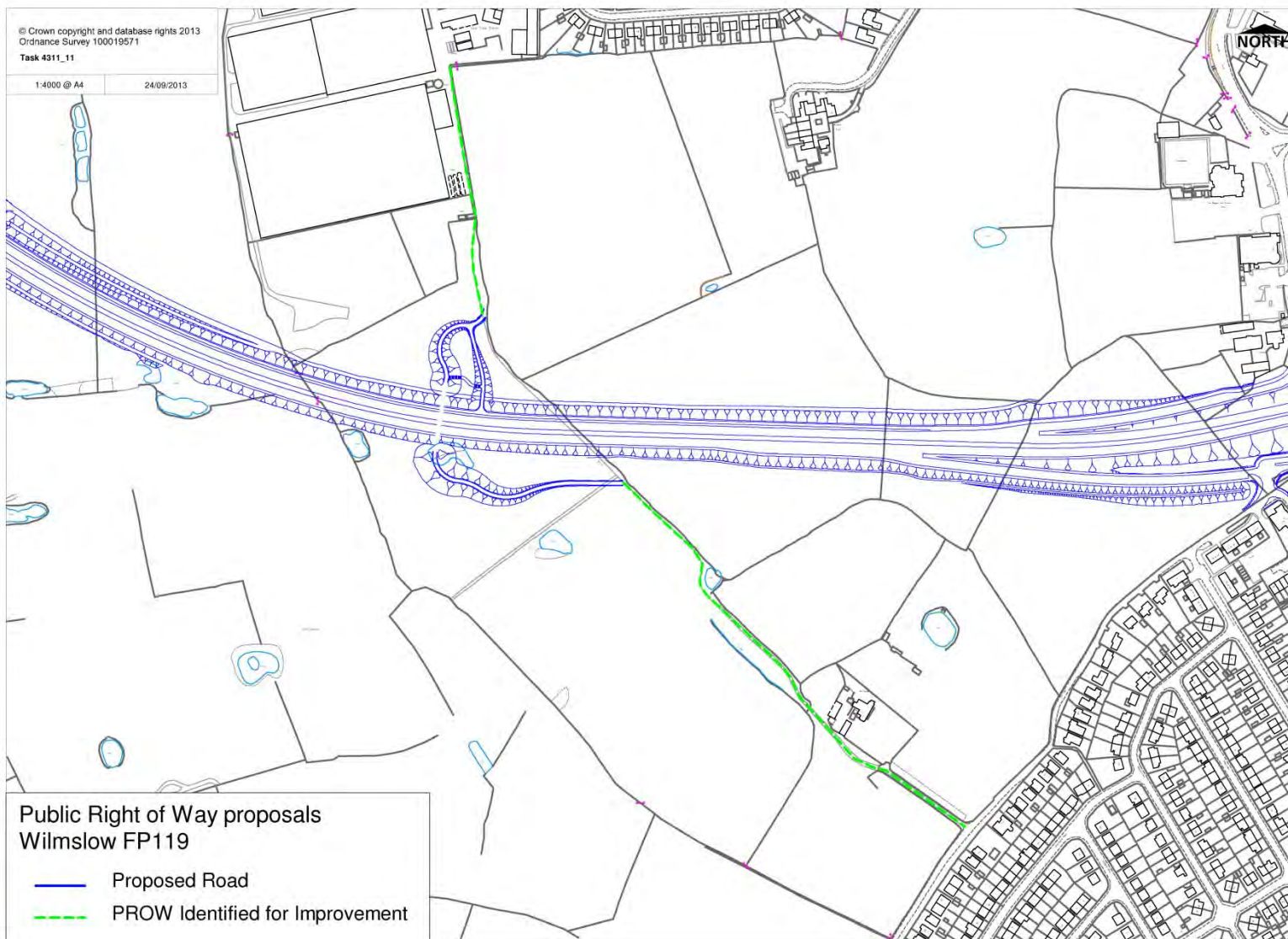

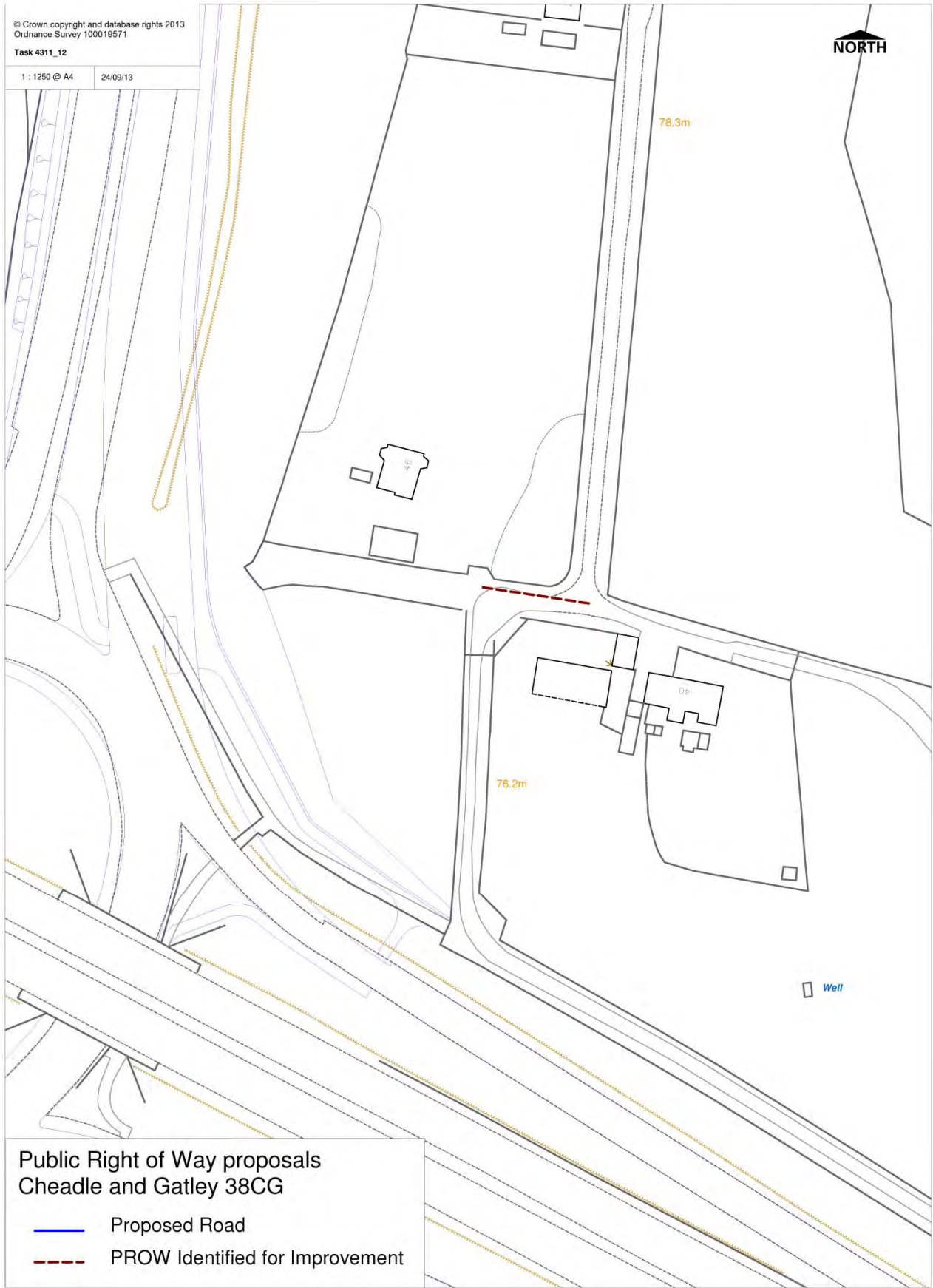

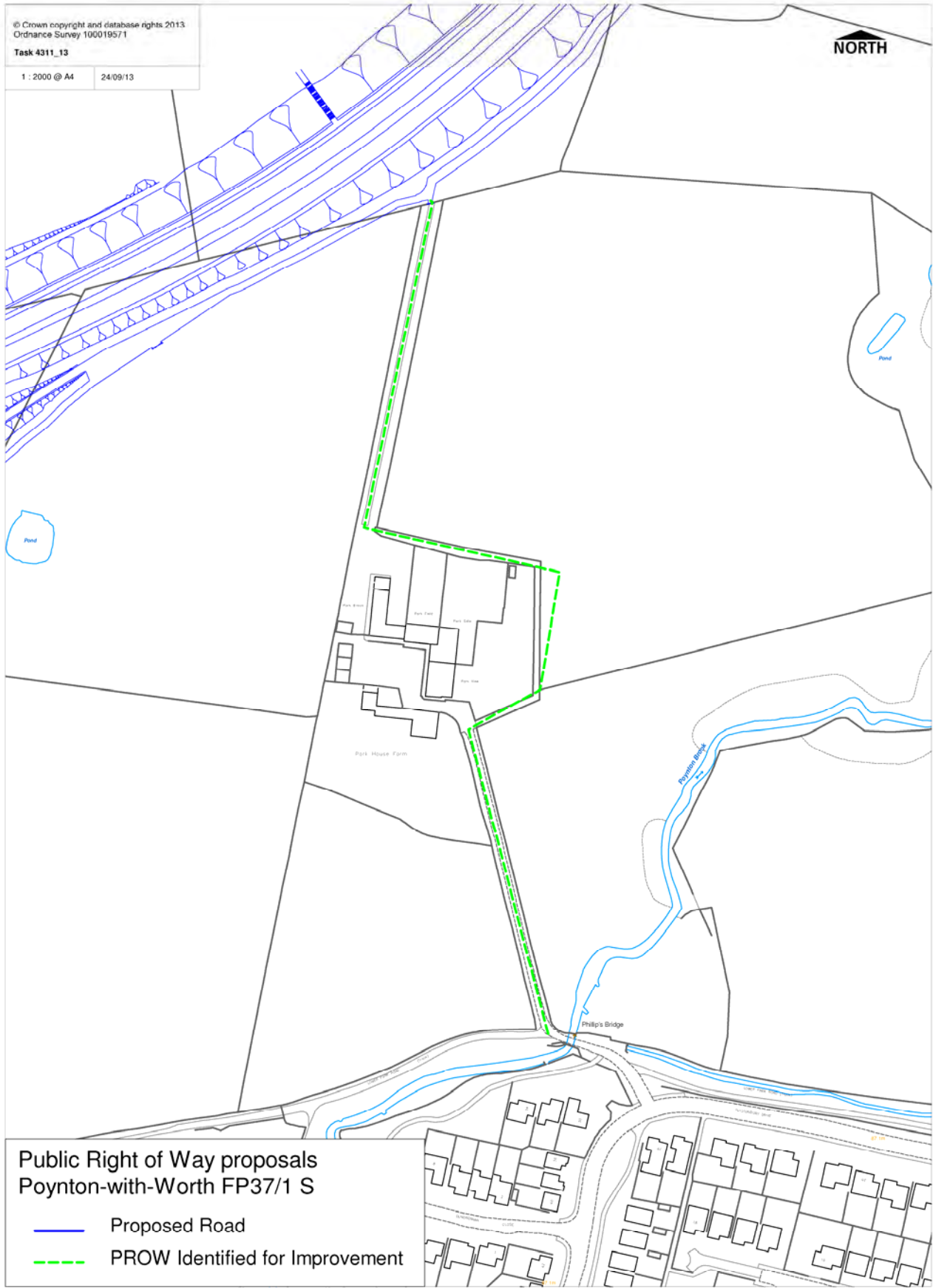





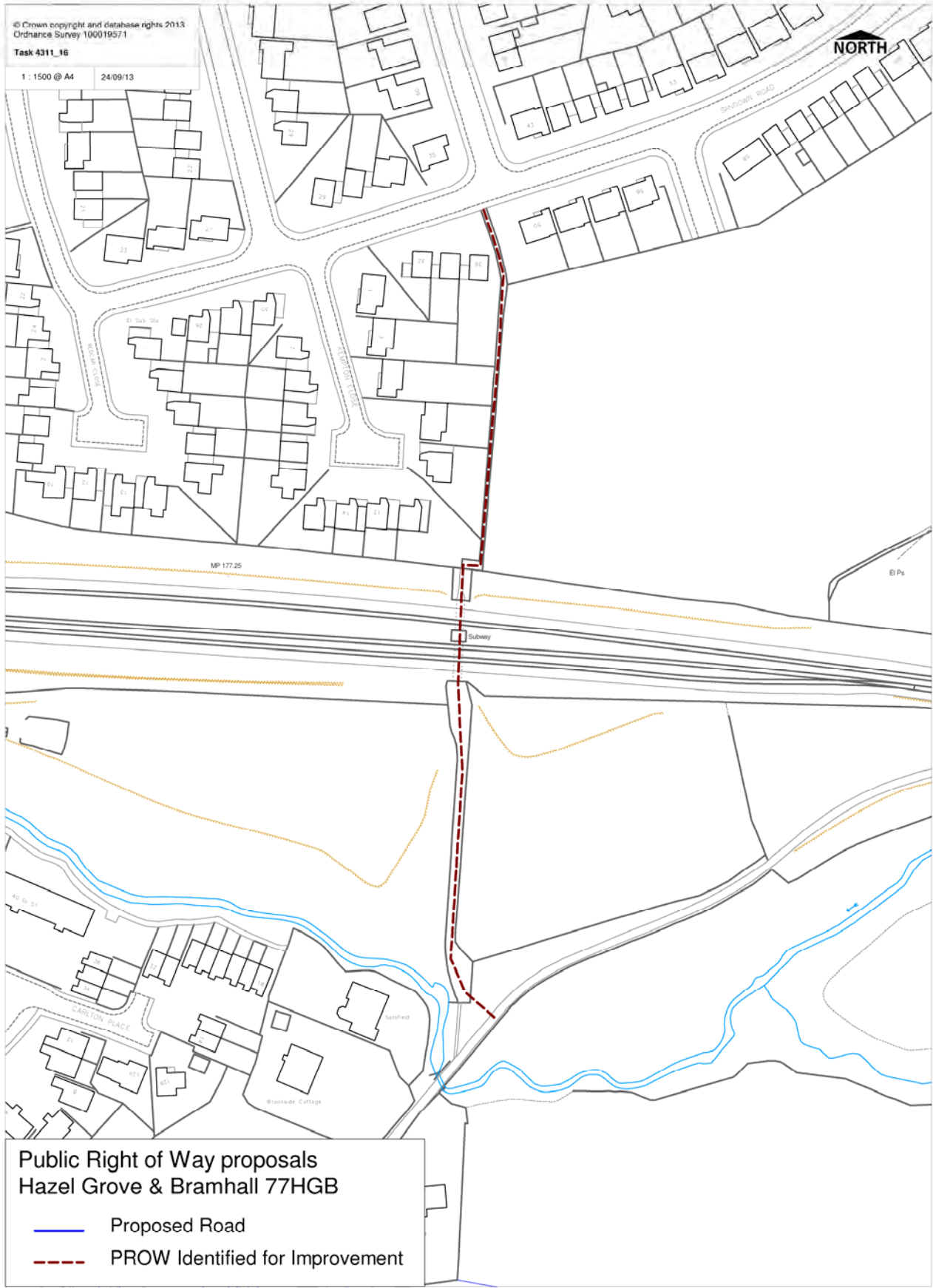

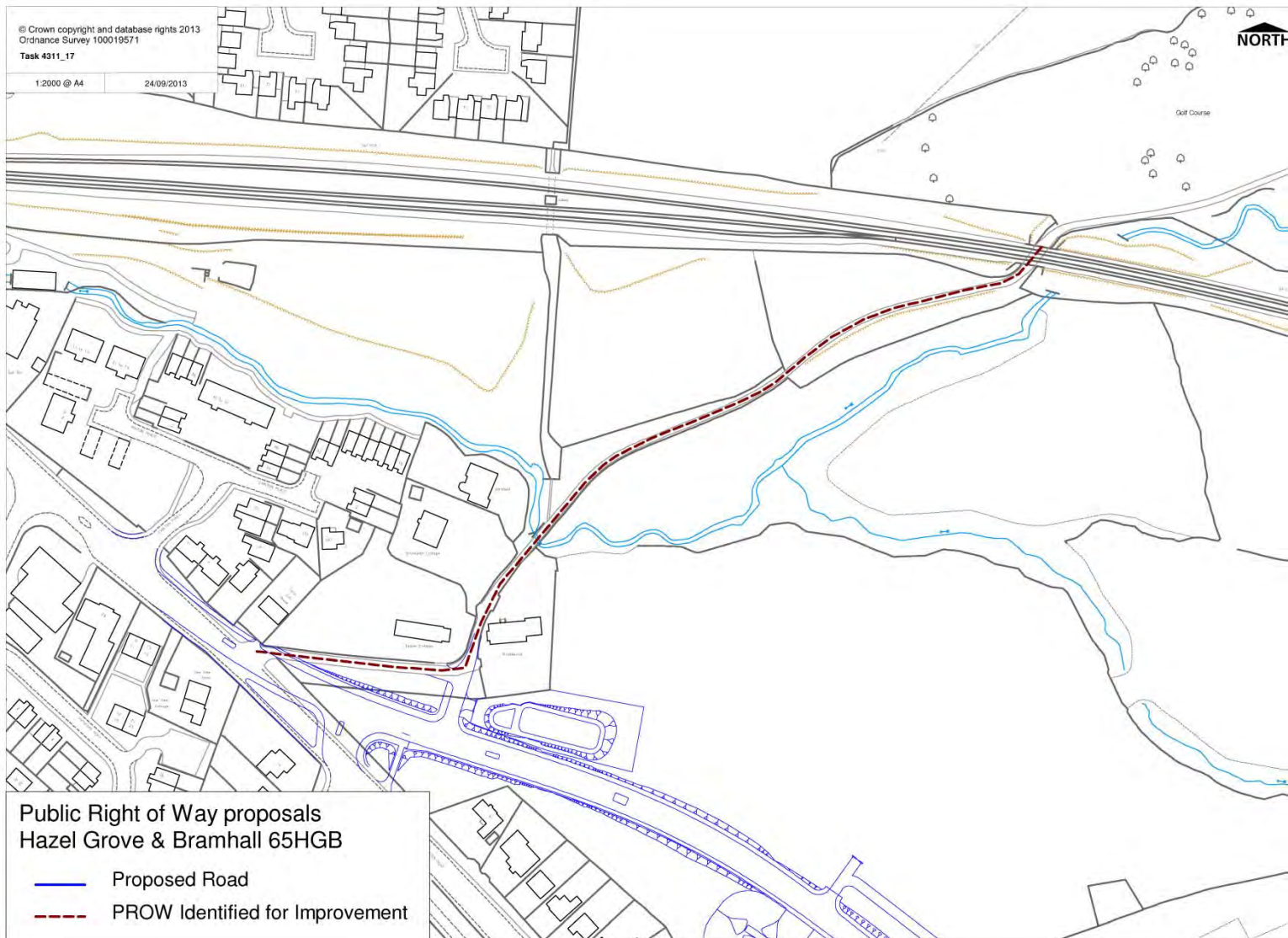

Appendix B – PRow Plans showing routes to be improved in the future if the opportunity arises

